



Midea Building Technologies Division

Engineering Data

R290 M thermal Arctic HT Series



CONTENTS

Part 1 General Information..... 3

Part 2 Engineering Data 18

Part 1

General Information

1 R290 M thermal Mono System	4
2 Product Lineup	6
3 Nomenclature	6
4 System Design and Unit Selection	7
5 Typical Applications	9

1 R290 M thermal Mono System

1.1 System Schematic

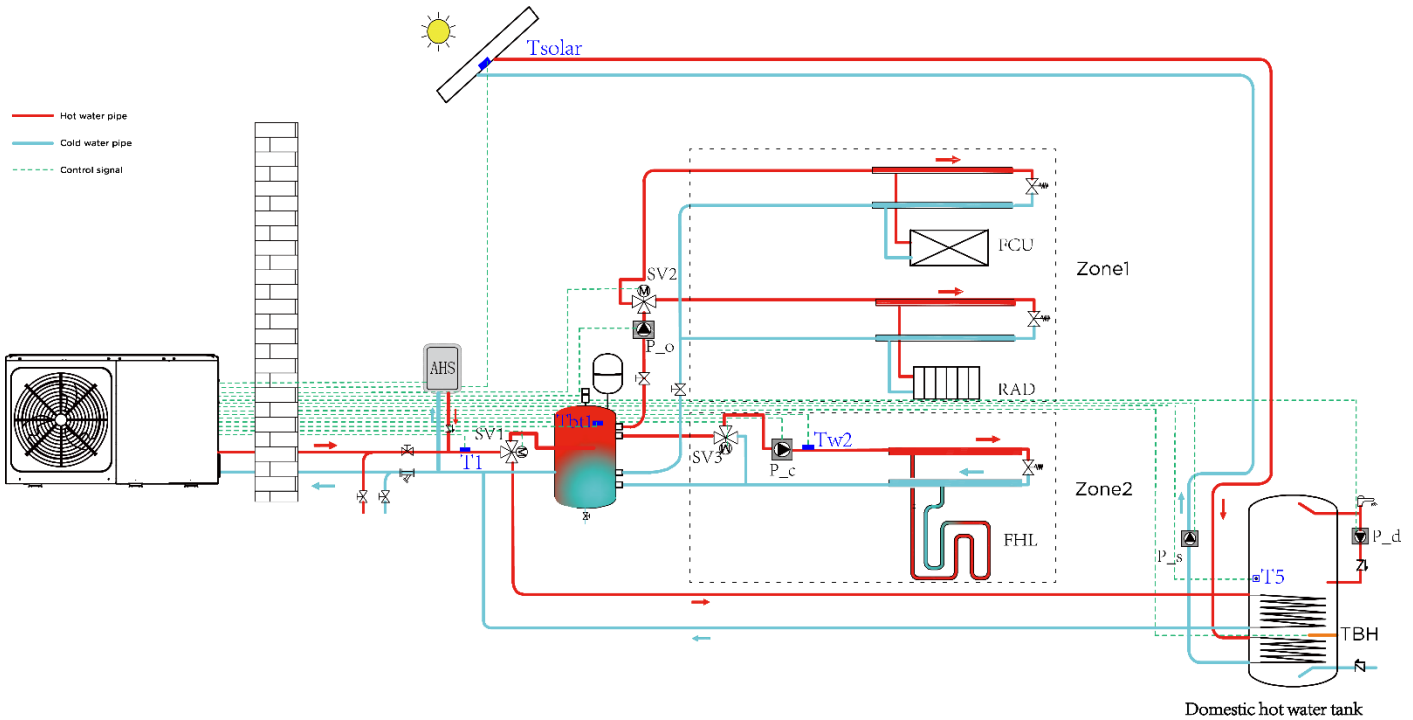

R290 M thermal is an integrated air to water heat pump system which is one-stop solution for space heating, space cooling and domestic hot water, The outdoor heat pump system extracts heat from the outdoor air and transfers this heat through refrigerant piping to the plate heat exchanger in the hydronic system. The heated water in the hydronic system circulates to low temperature heat emitters (floor heating loops or low temperature radiators) to provide space heating, and to the domestic hot water tank to provide domestic hot water. The 4-way valve in the outdoor unit can reverse the refrigerant cycle so that the hydronic system can provide chilled water for cooling by fan coil units.

The heating capacity of heat pumps decreases with ambient temperature dropping. R290 M thermal Mono can be equipped with a backup electric heater to provide additional heating capacity for use during extremely cold weather when the heat pump capacity is insufficient. The backup electric heater also serves as a backup in case of heat pump malfunction and for anti-freeze protection of the outside water piping in winter.

1.2 System Configurations

R290 M thermal Mono can be configured to run with the electric heater either enabled or disabled and can also be used in conjunction with an auxiliary heat source such as a boiler.

The chosen configuration affects the size of heat pump that is required. Three typical configurations are described below.

Configuration 1: Heat pump only

- The heat pump covers the required capacity and no extra heating capacity is necessary.
- Requires selection of larger capacity heat pump and implies higher initial investment.
- Ideal for new construction in projects where energy efficiency is paramount.

Configuration 2: Heat pump and backup electric heater



- Heat pump covers the required capacity until the ambient temperature drops below the point at which the heat pump is able to provide sufficient capacity. When the ambient temperature is below this equilibrium point (as shown below), the backup electric heater supplies the required additional heating capacity.
- Best balance between initial investment and running costs, results in lowest lifecycle cost.
- Ideal for new construction.

Configuration 3: Heat pump with auxiliary heat source

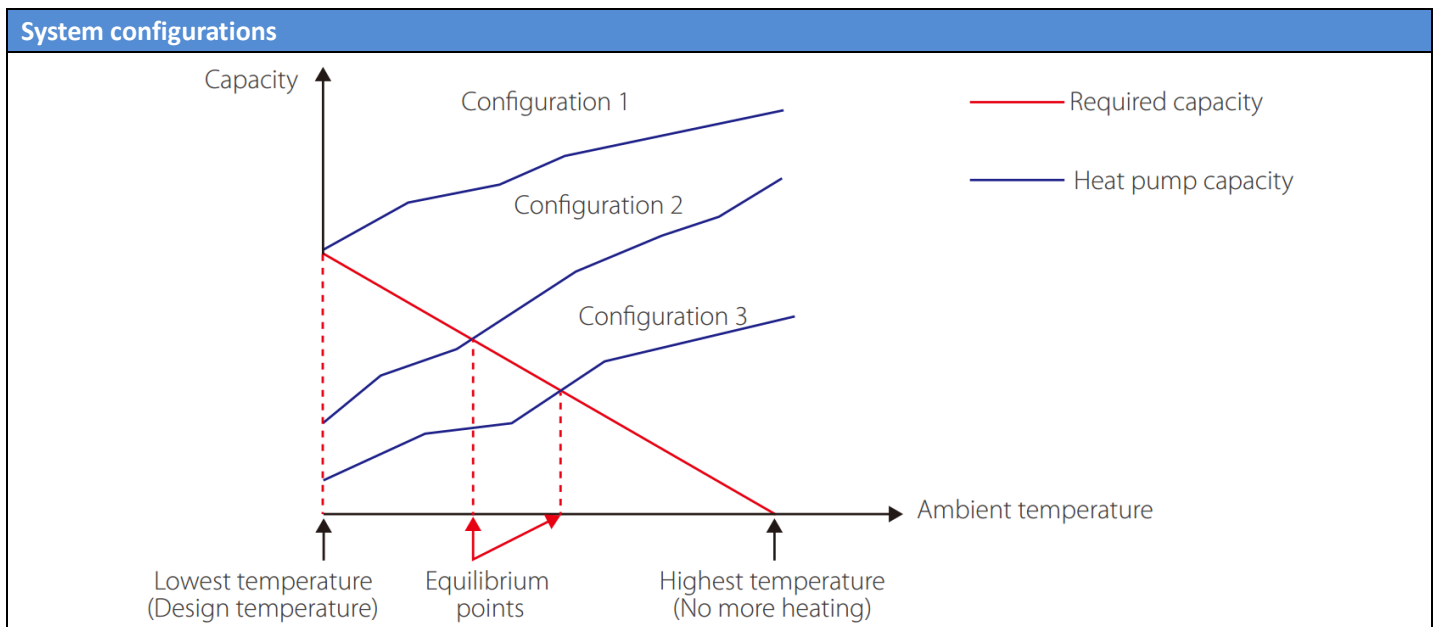
- Heat pump covers the required capacity until the ambient temperature drops below the point at which the heat pump is able to provide sufficient capacity. When the ambient temperature is below this equilibrium point (as shown below), depending on the system settings, either the auxiliary heat source supplies the required additional heating capacity or the heat pump does not run and the auxiliary heat source covers the required capacity.
- Enables selection of lower capacity heat pump.
- Ideal for refurbishments and upgrades.



2 Product Lineup

Power Supply	220-240V/1N/50Hz							380-415V/3N/50Hz		
Model	MHC-V4WD2N7	MHC-V6WD2N7	MHC-V8WD2N7	MHC-V10WD2N7	MHC-V12WD2N7	MHC-V14WD2N7	MHC-V16WD2N7	MHC-V12WD2RN7	MHC-V14WD2RN7	MHC-V16WD2RN7
Appearance										

3 Nomenclature

M	H	C	-	V	16	W	D2	R	N7
1	2	3		4	5	6	7	8	9

Legend		
No.	Code	Remarks
1	M	Brand: Midea brand
2	H	Unit type: heat pump
3	C	Structure: Mono
4	V	System type: Inverter
5	16	Capacity Code: 4: 4kW; 6: 6kW; 8: 8 kW; 10: 10 kW; 12: 12 kW; 14: 14 kW; 16: 16 kW;
6	W	Cooling type: Air cooling
7	D2	Compressor and fan motor types: All DC
8	R	Power Supply of heat pump R: 3-phase, 380-415V, 50Hz; Omitted: 1-phase, 220-240V, 50Hz
9	N7	Refrigerant: R290

4 System Design and Unit Selection

4.1 Selection Procedure

Step 1: Total heat load calculation

Calculate conditioned surface area
Select the heat emitters (type, quantity, water temperature and heat load)

Step 2: System configuration

Decide whether to include AHS and set AHS's switching temperature
Decide whether backup electric heater is enabled or disabled

Step 3: Selection of outdoor units

Determine required total heat load on outdoor units
Set capacity safety factor
Select power supply

Provisionally select R290 M thermal Mono unit capacity based on nominal capacity

Correct capacity of the outdoor units for the following items:
Outdoor air temperature / Outdoor humidity / Water outlet temperature¹ /
Altitude / Anti-freeze fluid

Is corrected R290 M thermal Mono unit capacity \geq Required total heat load on outdoor units²

Yes

No

R290 M thermal Mono system selection is complete

Select a larger model or enable backup electric heater operation

Notes:

1. If the required water temperatures of the heat emitters are not all the same, the R290 M thermal Mono's outlet water temperature setting should be set at the highest of the heat emitter required water temperatures. If the water outlet design temperature falls between two temperatures listed in the outdoor unit's capacity table, calculate the corrected capacity by interpolation.
2. If the outdoor unit selection is to be based on total heating load and total cooling load, select Mono units which satisfy not only the total heating load requirements but also the total cooling load requirements.

R290 M thermal Arctic HT Series



4.2 Selection tool

Midea Heat pump selection website: <https://www.midea-hpselection.com>

Easy selection: For quick and simple unit selection without registration

Professional selection: For detailed and professional unit selection with registration and authorization.

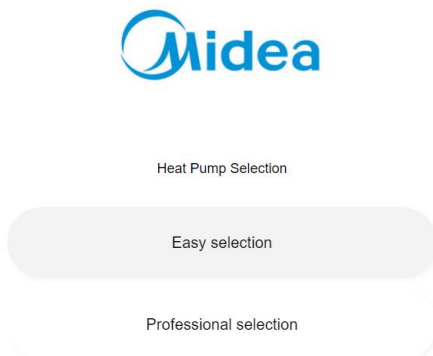

4.3 R290 M thermal Leaving Water Temperature (LWT) Selection

The recommended design LTW ranges for different types of heat emitter are:

- For floor heating: 30 to 35°C
- For fan coil units: 30 to 45°C
- For low temperature radiators: 40 to 50°C

4.4 Optimizing System Design

To get the most comfort with the lowest energy consumption with R290 M thermal, it is important to take account of the following considerations:

- Choose heat emitters that allow the heat pump system to operate at as low a hot water temperature as possible whilst still providing sufficient heating.
- Make sure the correct weather dependency curve is selected to match the installation environment (building structure, climate) as well as ender user's demands.
- Connecting room thermostat (supplied by user) to the hydronic system helps prevent excessive space heating by stopping the outdoor unit and circulation pump when the room temperature is above the thermostat set point.

5 Typical Applications

5.1 Controlled through the user interface

Single-zone control

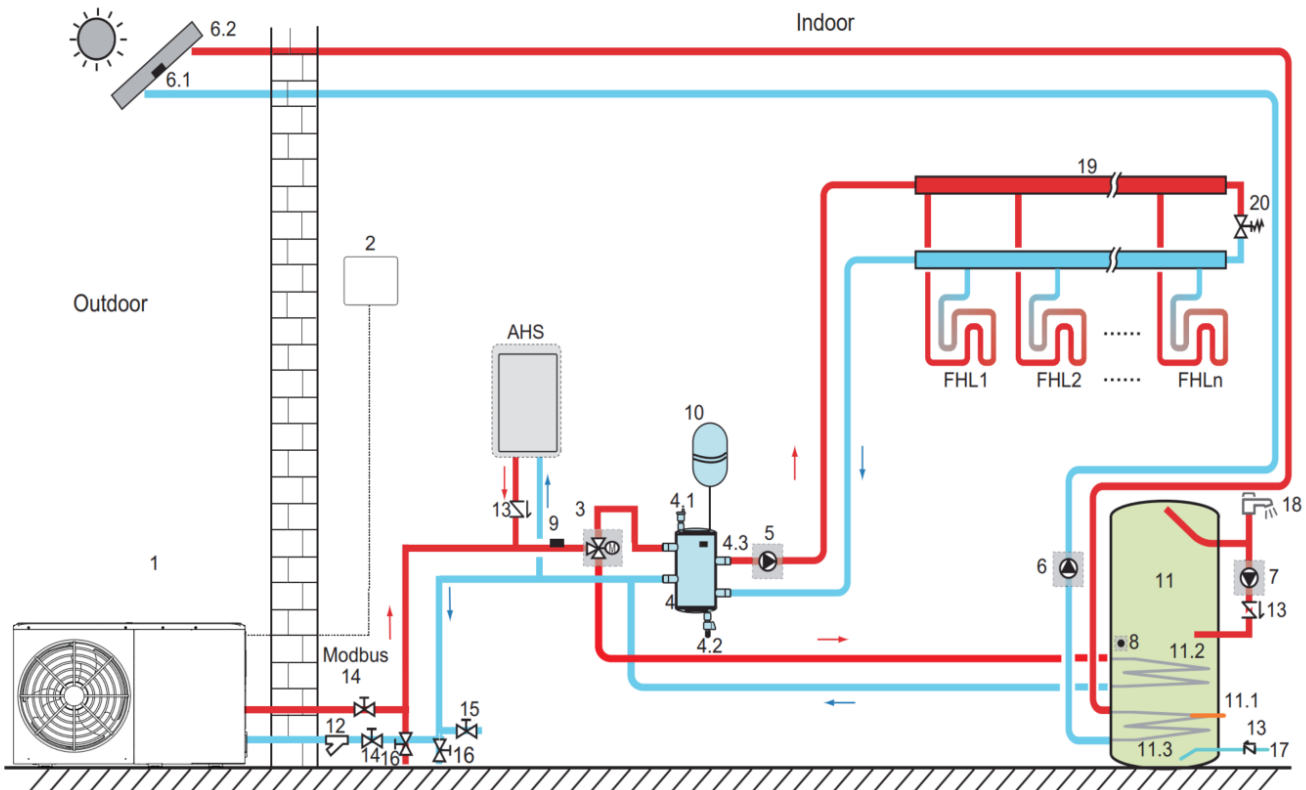

Legend			
1	Main Unit	11	Domestic hot water tank (Supplied by the user)
2	User interface	11.1	TBH: Domestic hot water tank booster heater (Supplied by the user)
3	SV1:3-way valve (Supplied by the user)	11.2	Coil 1, heat exchanger for heat pump
4	Balance tank (Supplied by the user)	11.3	Coil 2, heat exchanger for Solar energy
4.1	Automatic air purge valve	12	Filter (Accessory)
4.2	Drainage valve	13	Check valve (Supplied by the user)
4.3	Tbt1: Upper temperature sensor of balance tank (Optional)	14	Shut-off valve (Supplied by the user)
5	P_o: Outside circulation pump (Supplied by the user)	15	Filling valve (Supplied by the user)
6	P_s: Solar pump (Supplied by the user)	16	Drainage valve (Supplied by the user)
6.1	Tsolar: Solar temperature sensor (Optional)	17	Tap water inlet pipe (Supplied by the user)
6.2	Solar panel (Supplied by the user)	18	Hot water tap (Supplied by the user)
7	P_d: DWH pipe pump (Supplied by the user)	19	Collector/distributor (Supplied by the user)
8	T5: Temperature sensor of domestic water tank (Accessory)	20	Bypass valve (Supplied by the user)
9	T1: Final Water flow temperature sensor (Optional)	FHL1...n	Floor heating loop (Supplied by the user)
10	Expansion vessel (Supplied by the user)	AHS	Auxiliary heat source (Supplied by the user)

Notes:

1. The example is just for application illustration; please confirm the exact installation method according to the installation manual.
2. A bypass valve must be installed to make water recirculation possible when all shut-off valves are closed.

Space heating

The ON/OFF signal, operation mode, and temperature are set on the user interface. P_o keeps running as long as the unit is ON for space heating, while SV1 remains OFF.

Domestic water heating

The ON/OFF signal and target tank water temperature (T5S) are set on the user interface. P_o stops running as long as the unit is ON for domestic water heating while SV1 remains ON.

AHS (auxiliary heat source) control

The AHS function is set on the HMI (for maintenance personnel).

1) When the AHS is set to be valid only for heating mode, AHS can be turned on in the following ways:

- a. Turn on the AHS via BACKHEATER function on the user interface;
- b. AHS will be turned on automatically if the initial water temperature is too low or the target water temperature is too high at low ambient temperature.

P_o keeps running as long as the AHS is ON while SV1 remains OFF

2) The AHS is set to be valid for heating and DHW modes. In heating mode, AHS control is the same as item 1) listed above; In DHW mode, AHS will be turned on automatically when the initial domestic water temperature T5 is too low or the target domestic water temperature is too high at low ambient temperature. P_o stops running while SV1 remains ON.

3) When the AHS is set to be valid, M1M2 can be set to be valid on the user interface. In heating mode, AHS will be turned on when the M1M2 dry contact closes. This function is invalid in DHW mode.

TBH (tank booster heater) control

The TBH function is set on the user interface.

1) When the TBH is set to be valid, TBH can be turned on via TANKHEATER function on the user interface; In DHW mode, TBH will be turned on automatically when the initial domestic water temperature T5 is too low or the target domestic water temperature is too high at low ambient temperature.

2) When the TBH is set to be valid, M1M2 can be set to be valid on the user interface. TBH will be turned on when the M1M2 dry contact closes

Solar energy control

The unit recognizes solar energy signals by judging Tsolar or receiving SL1 SL2 signals from the user interface. The recognition method can be set via SOLAR INPUT on the user interface.

1) When Tsolar is set to be valid, solar energy turns ON when Tsolar is high enough, and P_s starts running; Solar energy turns OFF when Tsolar is low. and P_s stops running.

2) When SL1 SL2 control is set to be valid, solar energy turns ON after receiving solar kit signals from the user interface, and P_s starts running; If no solar kit signals are received, solar energy turns OFF, and P_s stops running.

Double-zone control

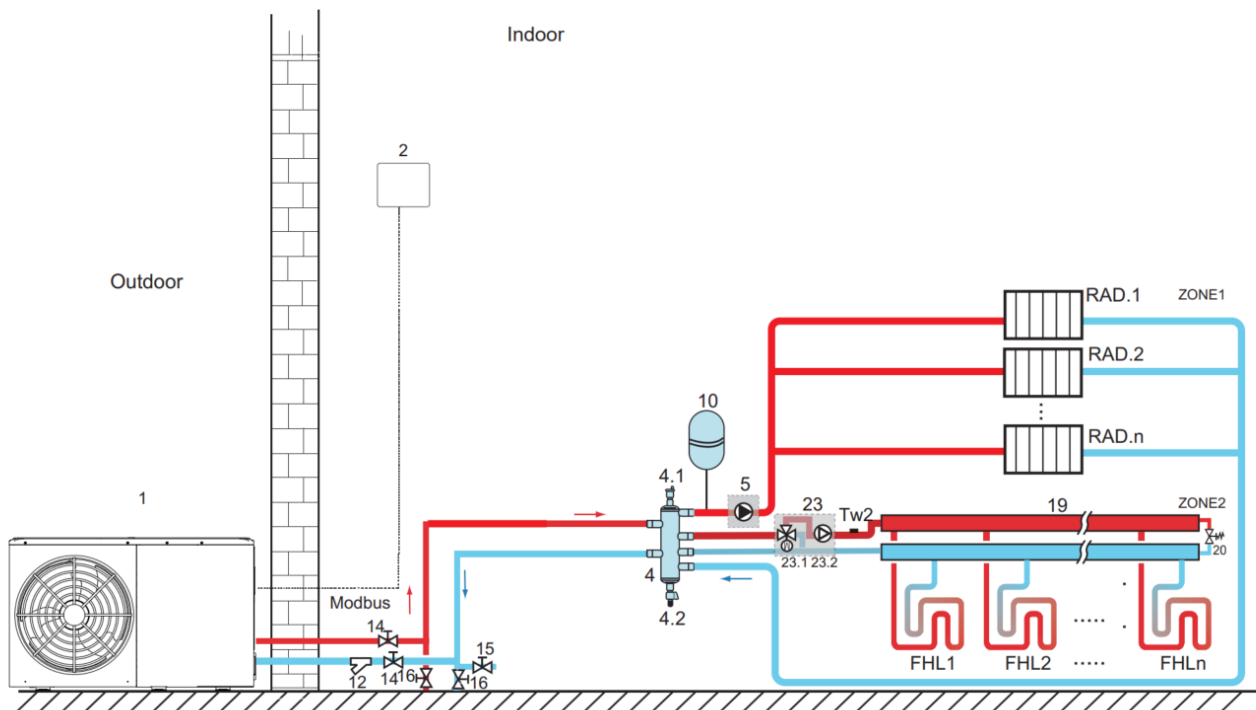

Legend			
1	Main Unit	16	Drainage valve (Supplied by the user)
2	User interface	19	Collector/distributor (Supplied by the user)
4	Balance tank (Supplied by the user)	20	Bypass valve (Supplied by the user)
4.1	Automatic air purge valve	23	Mixing station (Supplied by the user)
4.2	Drainage valve	23.1	SV3: Mixing valve (Supplied by the user)
5	P_o: Outside circulation pump (Supplied by the user)	23.2	P_c: Zone 2 circulation pump (Supplied by the user)
10	Expansion vessel (Supplied by the user)	Tw2	Temperature sensor of Zone 2 water flow
12	Filter (Accessory)	FHL1...n	Floor heating loop (Supplied by the user)
14	Shut-off valve (Supplied by the user)	RAD.1...n	Radiator(Supplied by the user)
15	Filling valve (Supplied by the user)		

Notes:

1. The example is just for application illustration; please confirm the exact installation method according to the installation manual.
2. A bypass valve must be installed to make water recirculation possible when all shut-off valves are closed.

Space heating

The ON/OFF signal, operation mode, and temperature are set on the user interface. Zone1 can operate in cooling mode or heating mode, while Zone 2 can only operate in heating mode; During operation, Zone1 is controlled by Final Water flow temperature (T1), Zone2 is controlled by Zone2 water outlet temperature(Tw2) or room temperature(Ta).

Circulation pump operation

When Zone1 turns ON, P_o starts running; When Zone1 turns OFF, P_o stops running;

When Zone2 turns ON, SV3 switches between ON and OFF according to the set TW2, and P_c remains ON; When Zone 2 turns OFF, SV3 remains OFF and P_c stops running.

The floor heating loops require a lower water temperature in heating mode than radiators or fan coil units. To reach the set temperature points, a mixing station is used to adapt the water temperature according to requirements of the floor heating loops. The radiators are directly connected to the unit's water circuit and the floor heating loops and after the mixing station. The mixing station is controlled by the unit.

The domestic water tank, AHS (auxiliary heat source), TBH (water tank electric auxiliary heat), and solar control can be connected. The control method is the same as what is described in the above section.

R290 M thermal Arctic HT Series



5.2 Control through the user interface and room thermostat

Space heating or cooling control through the room thermostat needs to be set on the user interface. It can be controlled through mode setting, single-zone control or double-zone control. The monoblock can only be connected to a low voltage room thermostat.

Single-zone control

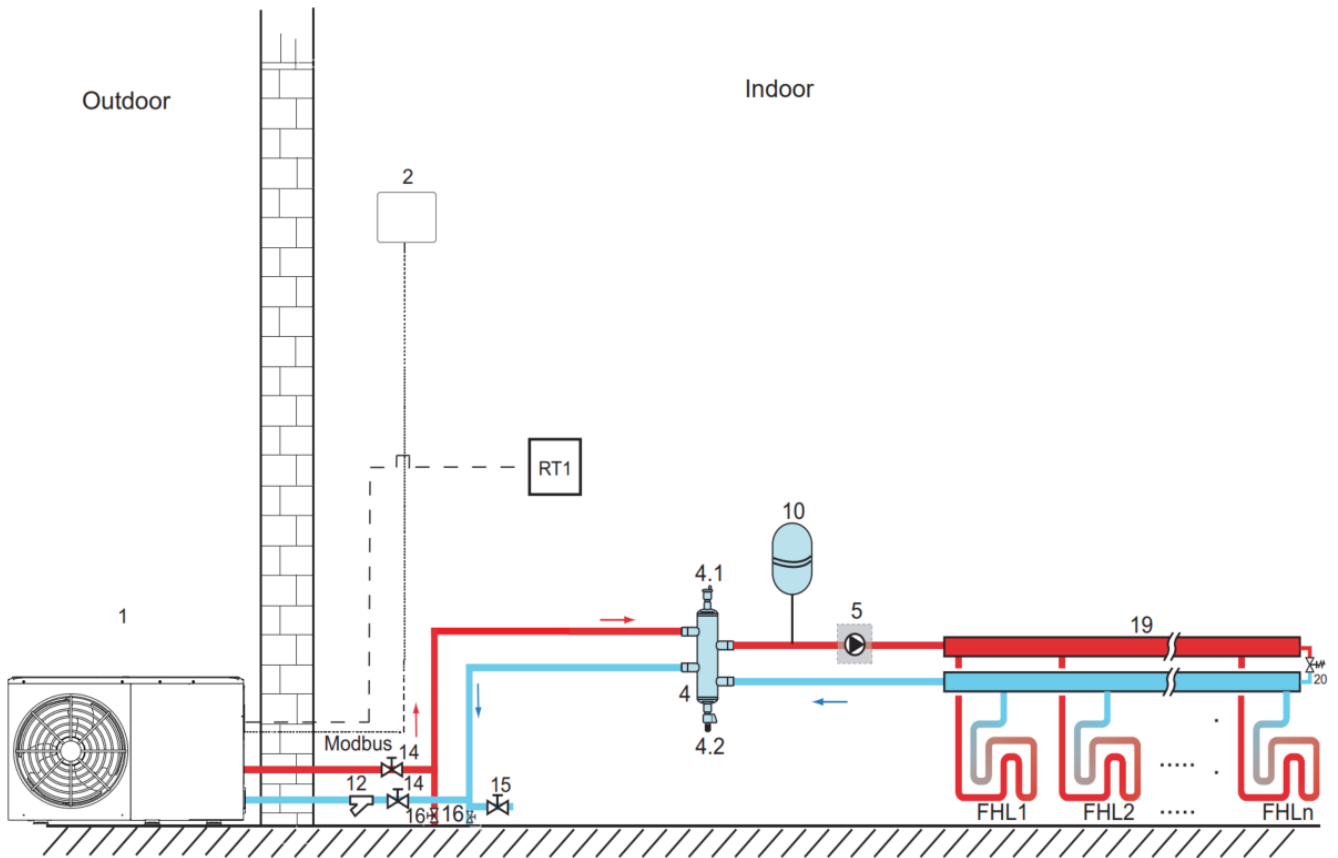

Legend			
1	Main Unit	14	Shut-off valve (Supplied by the user)
2	User interface	15	Filling valve (Supplied by the user)
4	Balance tank (Supplied by the user)	16	Drainage valve (Supplied by the user)
4.1	Automatic air purge valve	19	Collector/distributor (Supplied by the user)
4.2	Drainage valve	20	Bypass valve (Supplied by the user)
5	P_o: Outside circulation pump (Supplied by the user)	RT1	Low voltage room thermostat(Supplied by the user)
10	Expansion vessel (Supplied by the user)	FHL1...n	Floor heating loop (Supplied by the user)
12	Filter (Accessory)		

Notes:

1. The example is just for application illustration; please confirm the exact installation method according to the installation manual.
2. A bypass valve must be installed to make water recirculation possible when all shut-off valves are closed.

Space heating

Single-zone control: the unit ON/OFF is controlled by the room thermostat. The cooling or heating mode and outlet water temperature are set on the user interface. The system is ON when “HT” of the thermostat closes. When “HT” open, the system turns OFF.

Circulation pump operation

When the system turns ON, which means “HT” of the thermostat closes, P_o starts running; When the system turns OFF, which means “HT” open, P_o stops running.

The domestic water tank, AHS (auxiliary heat source), TBH (water tank electric auxiliary heat), and solar control can be connected. The control method is the same as what is described in the above section

Control through mode setting

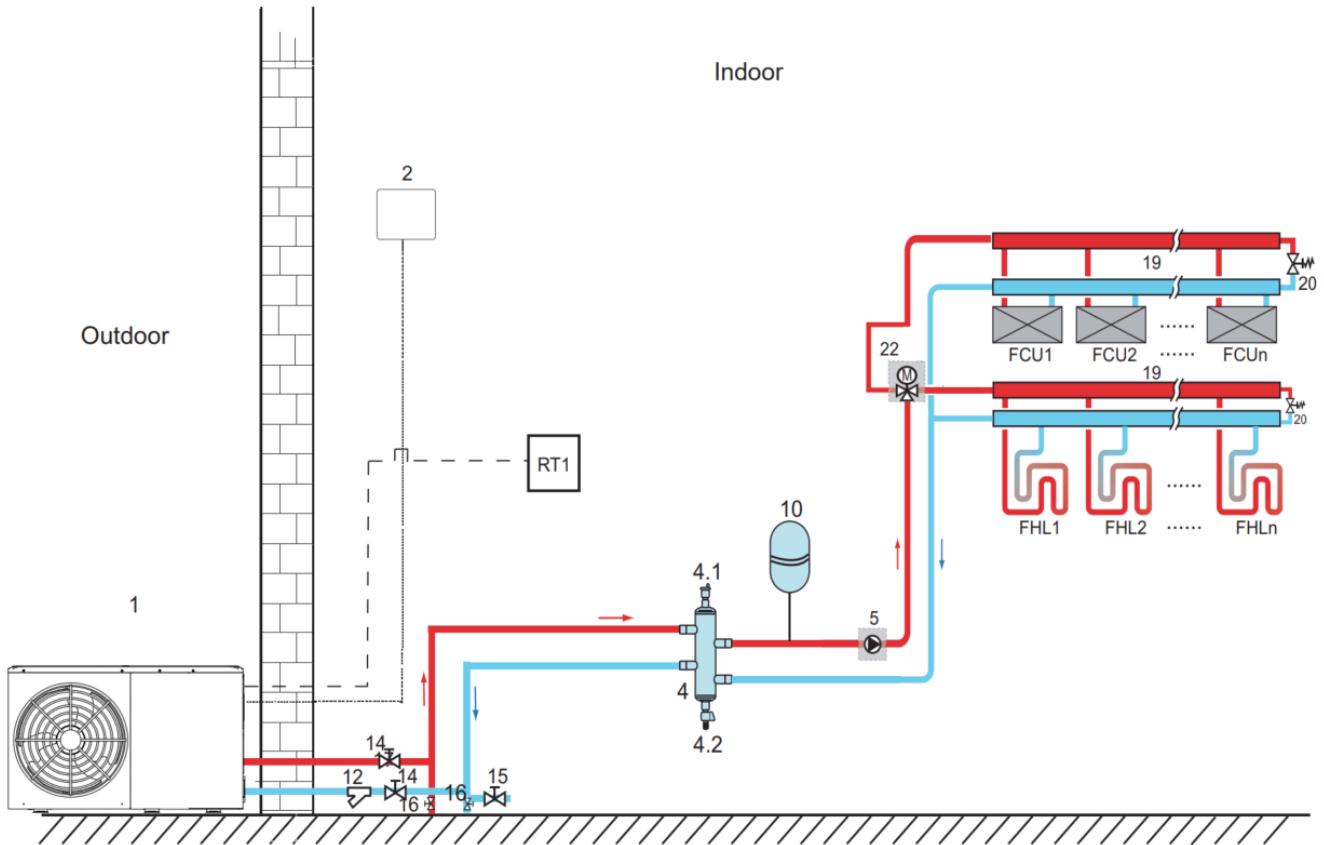

Legend			
1	Main Unit	15	Filling valve (Supplied by the user)
2	User interface	16	Drainage valve (Supplied by the user)
4	Balance tank (Supplied by the user)	19	Collector/distributor (Supplied by the user)
4.1	Automatic air purge valve	20	Bypass valve (Supplied by the user)
4.2	Drainage valve	22	SV2:3-way valve (Supplied by the user)
5	P_o: Outside circulation pump (Supplied by the user)	RT1	Low voltage room thermostat(Supplied by the user)
10	Expansion vessel (Supplied by the user)	FHL1...n	Floor heating loop (Supplied by the user)
12	Filter (Accessory)	FCU1...n	Fan coil unit (Supplied by the user)
14	Shut-ff valve (Supplied by the user)		

Notes:

1. The example is just for application illustration; please confirm the exact installation method according to the installation manual.
2. A bypass valve must be installed to make water recirculation possible when all shut-off valves are closed.

Space heating

The cooling or heating mode is set via the room thermostat, and the water temperature is set on the user interface.

- 1) When “CL” of the thermostat closes, the system will be set to work in cooling mode.
- 2) When “HT” of the thermostat closes and all “CL” open, the system will be set to work in heating mode.

Circulation pump operation

- 1) When the system is in cooling mode, which means “CL” of the thermostat closes, SV2 remains OFF while P_o starts running.
- 2) When the system is in heating mode, which means “HT” close and “CL” open, SV2 remains ON while P_o starts running.

The domestic water tank, AHS (auxiliary heat source), TBH (water tank electric auxiliary heat), and solar control can be connected. The control method is the same as what is described in the above section.

Double-zone control

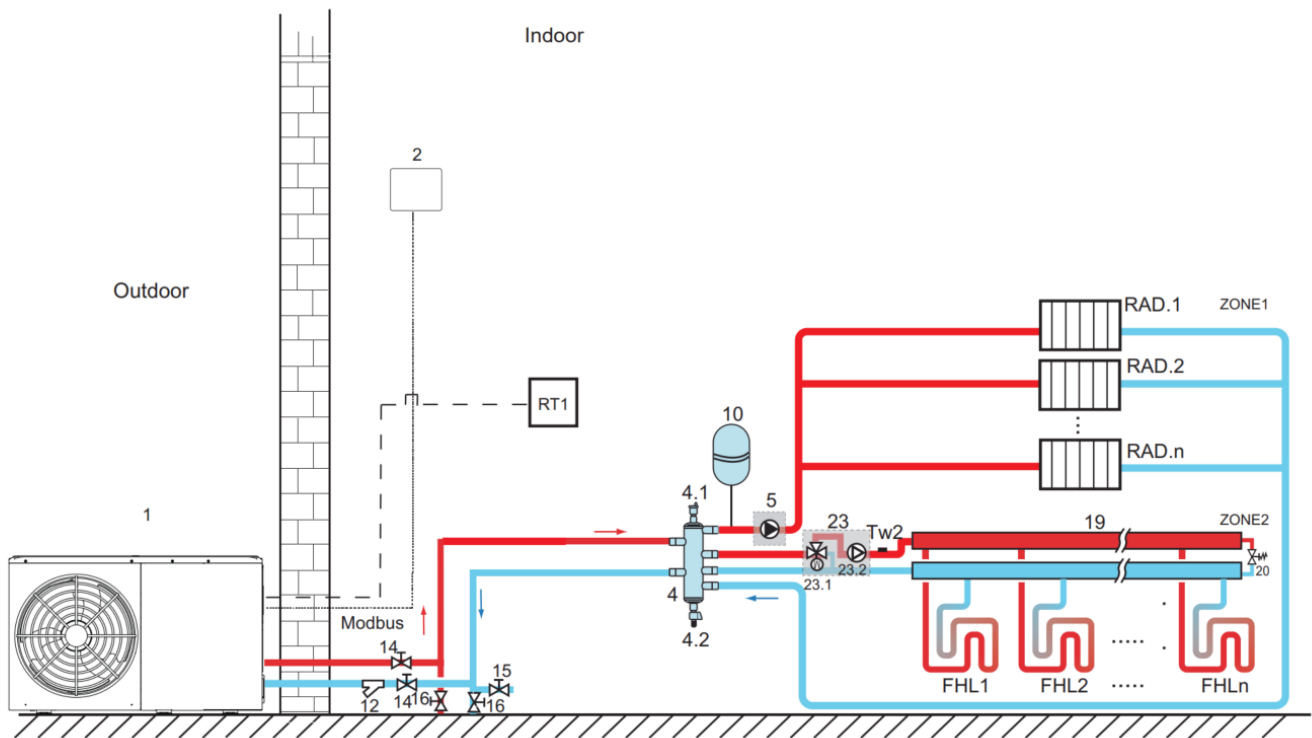

Legend			
1	Main Unit	16	Drainage valve (Supplied by the user)
2	User interface	19	Collector/distributor (Supplied by the user)
4	Balance tank (Supplied by the user)	20	Bypass valve (Supplied by the user)
4.1	Automatic air purge valve	23	Mixing station (Supplied by the user)
4.2	Drainage valve	23.1	SV3: Mixing valve (Supplied by the user)
5	P_o: Outside circulation pump (Supplied by the user)	23.2	P_c: Zone 2 circulation pump (Supplied by the user)
10	Expansion vessel (Supplied by the user)	RT1	Low voltage room thermostat (Supplied by the user)
12	Filter (Accessory)	Tw2	Temperature sensor of Zone 2 water flow
14	Shut-off valve (Supplied by the user)	FHL1...n	Floor heating loop (Supplied by the user)
15	Filling valve (Supplied by the user)	RAD.1...n	Radiator(Supplied by the user)

Notes:

1. The example is just for application illustration; please confirm the exact installation method according to the installation manual.
2. A bypass valve must be installed to make water recirculation possible when all shut-off valves are closed.

Space heating

Zone1 can operate in cooling mode or heating mode, while Zone 2 can only operate in heating mode; During installation, for thermostat in Zone1, only "HT" terminal need to be connected. For thermostat in Zone2, only "CL" terminals need to be connected.

1) The ON/OFF of Zone1 is controlled by the room thermostat there. When "HT" of thermostat in Zone1 closes, Zone 1 turns ON. When "HT" turn OFF, Zone 1 turns OFF; The target temperature and operation mode are set on the user interface.

2) In heating mode, the ON/OFF of Zone2 is controlled by the room thermostats there. When "CL" of temperature is set on the user interface; Zone 2 can only operate in heating mode. When cooling mode is set on the user interface, Zone2 remains OFF.

Circulation pump operation

When Zone1 turns ON, P_o starts running; When Zone1 turns OFF, P_o stops running;

When Zone2 turns ON, SV3 switches between ON and OFF according to the set TW2, and P_c remains ON; When Zone 2 Turns OFF, SV3 remains OFF and P_c stops running.

The floor heating loops require a lower water temperature in heating mode than radiators or fan coil units. To reach the set temperature points, a mixing station is used to adapt the water temperature according to requirements of the floor heating loops. The radiators are directly connected to the unit's water circuit and the floor heating loops and after the mixing station. The mixing station is controlled by the unit.

The domestic water tank, AHS (auxiliary heat source), TBH (water tank electric auxiliary heat), and solar control can be connected. The control method is the same as what is described in the above section.

5.3 Cascade system

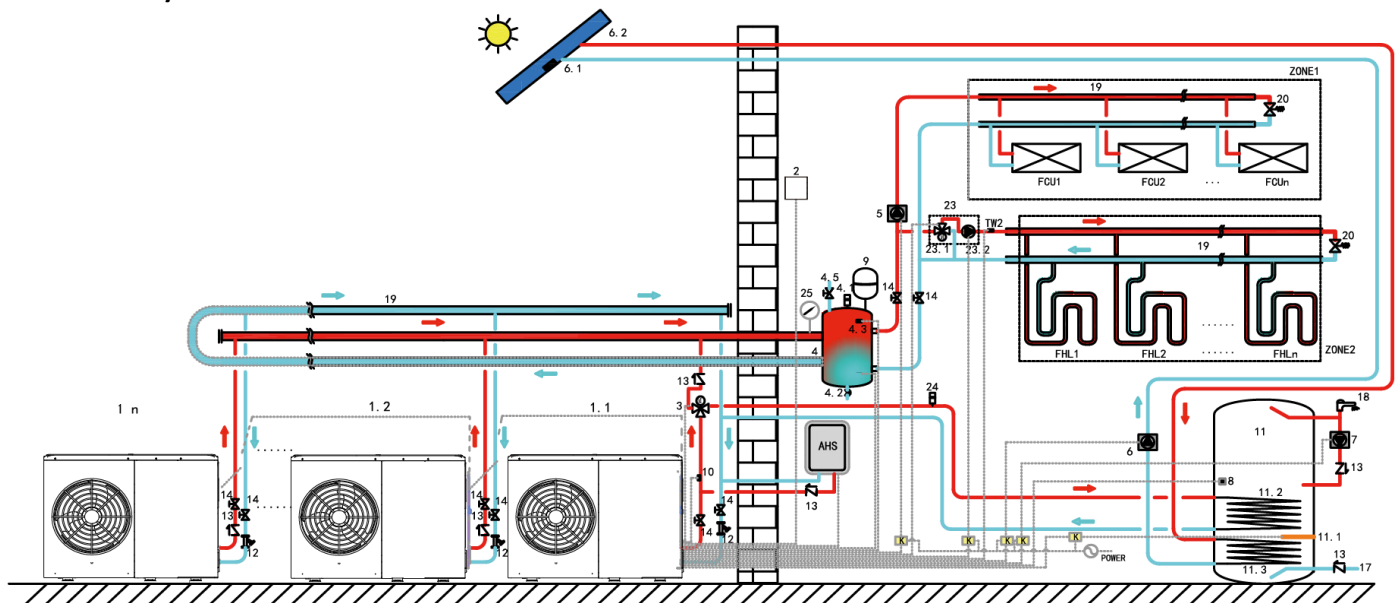

Legend			
1.1	Master Unit	12	Filter (Accessory)
1.2...n	Slave Unit	13	Check valve (Supplied by the user)
2	User interface	14	Shut-off valve (Supplied by the user)
3	SV1:3-way valve (Supplied by the user)	17	Tap water inlet pipe (Supplied by the user)
4	Balance tank (Supplied by the user)	18	Hot water tap (Supplied by the user)
4.1	Automatic air purge valve	19	Collector/distributor (Supplied by the user)
4.2	Drainage valve	20	Bypass valve (Supplied by the user)
4.3	Tbt1: Upper temperature sensor of balance tank (Optional)	23	Mixing station
4.5	Filling valve	23.1	SV3: Mixing valve
5	P_o: Outside circulation pump (Supplied by the user)	23.2	P_c: Zone 2 circulation pump (Supplied by the user)
6	P_s: Solar pump (Supplied by the user)	24	Automatic air purge valve(Supplied by the user)
6.1	Tsolar: Solar temperature sensor (Optional)	25	Water manometer (Supplied by the user)
6.2	Solar panel (Supplied by the user)	TW2	Zone 2 water flow temperature sensor (Supplied by the user)
7	P_d: DHW pipe pump (Supplied by the user)	FCU1...n	Fan coil unit (Supplied by the user)
8	T5: Temperature sensor of domestic water tank (Accessory)	FHL1...n	Floor heating loop (Supplied by the user)
9	T1: Final Water flow temperature sensor (Optional)	K	Contactora (Supplied by the user)
10	Expansion vessel (Supplied by the user)	ZONE 1	Only heating mode is applicable to the space
11	Domestic hot water tank (Supplied by the user)	ZONE 2	Only heating mode is applicable to the space
11.1	TBH: Domestic hot water tank booster heater (Supplied by the user)	AHS	Auxiliary heat source (Supplied by the user)
11.2	Coil 1, heat exchanger for heat pump		
11.3	Coil 2, heat exchanger for Solar energy		

Notes:

1. The example is just for application illustration; please confirm the exact installation method according to the installation manual.
2. A bypass valve must be installed to make water recirculation possible when all shut-off valves are closed.

Domestic water heating

Only the master unit can operate in DHW mode. T5S is set on the user interface. In DHW mode, SV1 remains ON. When the master unit operates in DHW mode, the slave units can operate in space cooling/heating mode.

Heating mode of slave units

All slave units can operate in space heating mode. The operation mode and temperature are set on the user interface. Due to changes of the outdoor temperature and the required load indoors, multiple outdoor units may operate at different time points.

In cooling mode, SV3 and P_c remains OFF while P_o remains ON.

In heating mode, when both Zone 1 and Zone 2 work, P_c and P_o remain ON, and SV3 switches between ON and OFF according to the set TW2.

In heating mode, when only Zone 1 works, P_o remains ON while SV3 and P_c remain OFF.

In heating mode, when only Zone 2 works, P_o remains OFF while P_c remains ON, and SV3 switches between ON and OFF according to the set TW2.

AHS (Auxiliary heat source) control

The AHS should be set via the DIP switch on the main board. The AHS is only controlled by the master unit. When the master unit operates in DHW mode, the AHS can only be used for producing domestic hot water; When the master unit operates in heating mode, the AHS can only operate in heating mode.

1) When the AHS is set to be valid only in heating mode, it will be turned on in the following conditions:

- a. The BACKUPHEATER function is enabled on user interface;
- b. The master unit operates in heating mode. When the inlet water temperature or ambient temperature is too low while the target leaving water temperature is too high, the AHS will be turned on automatically.

2) When the AHS is set to be valid in heating mode and DHW mode, it will be turned on in following conditions:

When the master unit operates in heating mode, conditions for turning on the AHS is same as 1); When the master unit operates in DHW mode, if T5 or the ambient temperature is too low while the target T5 temperature is too high, the AHS will be turned on automatically.

3) When the AHS is valid, the operation of the AHS is controlled by M1M2. When M1M2 closes, the AHS is turned on.

When the master unit operates in DHW mode, the AHS can not be turned on by closing M1 M2.

TBH (Tank booster heater) control

The TBH should be set via the DIP switch on the main board. The TBH is only controlled by the master unit.

Solar energy control

Solar energy is only controlled by the master unit.

Part 2

Engineering Data

1 Specifications.....	19
2 Electrical Characteristics.....	23
3 Dimensions And Center Of Gravity	24
4 Operating Limits	25
5 Hydronic Performance	27
6 Capacity Tables	29
7 Sound Levels.....	64

1 Specifications

Outdoor unit			MHC-V4WD2N7	MHC-V6WD2N7	MHC-V8WD2N7	MHC-V10WD2N7
Power supply	V/Ph/Hz		220-240/1/50			
Heating A7W35	Capacity	W	4500	6200	8400	10000
	Rated input	W	874	1265	1680	2128
	COP		5.15	4.90	5.00	4.70
Heating A7W45	Capacity	W	4500	6400	8200	10000
	Rated input	W	1111	1684	2130	2740
	COP		4.05	3.80	3.85	3.65
Heating A7W55	Capacity	W	4600	6200	7800	9500
	Rated input	W	1438	2000	2438	3115
	COP		3.20	3.10	3.20	3.05
Heating A2W35	Capacity	W	4400	5600	7100	8200
	Rated input	W	1073	1436	1844	2247
	COP		4.10	3.90	3.85	3.65
Heating A2W45	Capacity	W	4400	5800	7700	8200
	Rated input	W	1313	1871	2567	2780
	COP		3.35	3.10	3.00	2.95
Heating A2W55	Capacity	W	4600	5800	7800	8400
	Rated input	W	1704	2189	3059	3360
	COP		2.70	2.65	2.55	2.50
Heating A-7W35	Capacity	W	4500	5900	7000	8000
	Rated input	W	1452	2000	2333	2807
	COP		3.10	2.95	3.00	2.85
Heating A-7W45	Capacity	W	4700	5500	7100	7600
	Rated input	W	1741	2200	3087	3378
	COP		2.70	2.50	2.30	2.25
Heating A-7W55	Capacity	W	4700	5200	6900	7400
	Rated input	W	2136	2419	3209	3524
	COP		2.20	2.15	2.15	2.10
Cooling A35W18	Capacity	W	4500	6500	8300	10000
	Rated input	W	818	1275	1612	2105
	EER		5.50	5.10	5.15	4.75
Cooling A35W7	Capacity	W	4700	6800	7500	8900
	Rated input	W	1288	2194	2174	2738
	EER		3.65	3.10	3.45	3.25
Seasonal space heating energy efficiency class	Water outlet at 35°C		A+++			
	Water outlet at 55°C		A++			
SCOP	Warmer climate	35°C	5.97	6.14	6.56	7.11
		55°C	4.34	4.55	4.68	4.79
	Average climate	35°C	5.07	4.89	5.19	5.07
		55°C	3.79	3.82	3.82	3.82
	Colder climate	35°C	4.03	4.24	4.44	4.54
		55°C	3.18	3.38	3.46	3.49

R290 M thermal Arctic HT Series



SEER	Water outlet	7°C	5.23	5.32	5.86	5.55
		18°C	6.36	6.65	8.14	8.16
Sound power Level		dB	56	58	60	61
Sound pressure level (1m) A7W35		dB(A)	44	46	48	49
Water flow range		m3/h	0.40-0.90	0.40-1.25	0.40-1.65	0.40-2.10
Compressor	Type	Twin rotary				
Outdoor fan	Motor type / Number of fans	DC fan / 1				
Air side heat exchanger		Finned tube heat exchanger				
Refrigerant		R290 700g			R290 1100g	
Unit dimension (WxHxD)		mm	1299x717x426			1385x865x523
Packing dimension (WxHxD)		mm	1375x885x475			1465x1035x560
Net weight		kg	90			117
Gross weight		kg	110			139
Water side heat exchanger		Plate heat exchanger				
Water side Connection dimension		G1"BSP			G1 1/4"BSP	
Water pump	Max. pump head	m	9			
Expansion vessel (Primary circuit)	Nominal volume	L	8			
	Max. working pressure	Bar	8			
Safety valve		Mpa	0.3			
Flow switch		m3/h	0.36			
Outdoor air temperature range	Cooling	°C	-5~46			
	Heating	°C	-25~35			
	DHW	°C	-25~46			
Water setting temperature range	Cooling	°C	5~30			
	Heating	°C	12~75			
	DHW	°C	10~70			
Notes:						
The above data test reference standard EN14511; EN14825; EN50564;EN 12102; (EU) No:811						

Outdoor unit		MHC-V12WD2N7	MHC-V14WD2N7	MHC-V16WD2N7	MHC-V12WD2RN7	MHC-V14WD2RN7	MHC-V16WD2RN7	
Power supply		V/Ph/Hz	220-240/1/50			380-415/3/50		
Heating A7W35	Capacity	W	12000	14000	15000	12000	14000	15000
	Rated input	W	2500	3111	3409	2500	3111	3409
	COP		4.80	4.50	4.40	4.80	4.50	4.40
Heating A7W45	Capacity	W	12000	14000	15000	12000	14000	15000
	Rated input	W	3243	4000	4478	3243	4000	4478
	COP		3.70	3.50	3.35	3.70	3.50	3.35
Heating A7W55	Capacity	W	12000	14000	15000	12000	14000	15000
	Rated input	W	3871	4667	5263	3871	4667	5263
	COP		3.10	3.00	2.85	3.10	3.00	2.85
Heating A2W35	Capacity	W	9100	10800	12800	9100	10800	12800
	Rated input	W	2395	3086	4000	2395	3086	4000
	COP		3.80	3.50	3.20	3.80	3.50	3.20
Heating A2W45	Capacity	W	11300	12000	13100	11300	12000	13100
	Rated input	W	3897	4211	4764	3897	4211	4764
	COP		2.90	2.85	2.75	2.90	2.85	2.75
Heating A2W55	Capacity	W	11300	12000	13100	11300	12000	13100
	Rated input	W	4431	4800	5347	4431	4800	5347
	COP		2.55	2.50	2.45	2.55	2.50	2.45
Heating A-7W35	Capacity	W	10000	11500	12700	10000	11500	12700
	Rated input	W	3571	4259	5080	3571	4259	5080
	COP		2.80	2.70	2.50	2.80	2.70	2.50
Heating A-7W45	Capacity	W	10500	11400	12500	10500	11400	12500
	Rated input	W	4286	4957	5556	4286	4957	5556
	COP		2.45	2.30	2.25	2.45	2.30	2.25
Heating A-7W55	Capacity	W	10400	11300	12400	10400	11300	12400
	Rated input	W	4837	5381	6049	4837	5381	6049
	COP		2.15	2.10	2.05	2.15	2.10	2.05
Cooling A35W18	Capacity	W	12000	14000	16000	12000	14000	16000
	Rated input	W	2667	3333	4103	2667	3333	4103
	EER		4.50	4.20	3.90	4.50	4.20	3.90
Cooling A35W7	Capacity	W	11500	12700	14000	11500	12700	14000
	Rated input	W	3770	4379	5091	3770	4379	5091
	EER		3.05	2.90	2.75	3.05	2.90	2.75
Seasonal space heating energy efficiency class	Water outlet at 35°C		A+++					
	Water outlet at 55°C		A++					
SCOP	Warmer climate	35°C	5.9	5.85	6.05	5.9	5.85	6.05
		55°C	4.45	4.43	4.62	4.45	4.43	4.62
	Average climate	35°C	4.67	4.63	4.59	4.67	4.64	4.59
		55°C	3.62	3.61	3.57	3.62	3.61	3.57
	Colder climate	35°C	4.13	4.13	4.08	4.13	4.13	4.08
		55°C	3.26	3.23	3.29	3.26	3.23	3.29

R290 M thermal Arctic HT Series



SEER	Water outlet	7°C	5.19	5.18	5.12	5.19	5.18	5.12
		18°C	6.42	6.75	6.65	6.42	6.75	6.65
Sound power Level		dB	65	65	69	65	65	69
Sound pressure level (1m) A7W35		dB(A)	51	52	56	51	52	56
Water flow range		m3/h	0.70-2.50	0.70-2.75	0.70-3.00	0.70-2.50	0.70-2.75	0.70-3.00
Compressor	Type	Twin rotary						
Outdoor fan	Motor type	DC fan						
	Number of fans	1						
Air side heat exchanger		Finned tube heat exchanger						
Refrigerant		R290 1250g						
Unit dimension (WxHxD)		mm	1385x865x523					
Packing dimension (WxHxD)		mm	1465x1035x560					
Net weight		kg	135			137		
Gross weight		kg	157			159		
Water side heat exchanger		Plate heat exchanger						
Water side Connection dimension		G1 1/4"BSP						
Water pump	Max. pump head	m	9					
Expansion vessel (Primary circuit)	Nominal volume	L	8					
	Max. working pressure	Bar	8					
Safety valve		Mpa	0.3					
Flow switch		m3/h	0.6					
Outdoor air temperature range	Cooling	°C	-5~46					
	Heating	°C	-25~35					
	DHW	°C	-25~46					
Water setting temperature range	Cooling	°C	5~30					
	Heating	°C	12~75					
	DHW	°C	10~70					
Notes:								
The above data test reference standard EN14511; EN14825; EN50564;EN 12102; (EU) No:811								

2 Electrical characteristics

System	Outdoor unit			Power current			Compressor		Fan	
	Power supply	Min. (V)	Max. (V)	MCA (A)	TOCA (A)	MFA (A)	MSC (A)	RLA (A)	kW	FLA (A)
MHC-V4WD2N7	220~240/1N/50Hz	198	264	12	15	16	/	10	0.08	0.32
MHC-V6WD2N7	220~240/1N/50Hz	198	264	13.5	15	16	/	10	0.08	0.32
MHC-V8WD2N7	220~240/1N/50Hz	198	264	16	19	20	/	13	0.17	0.80
MHC-V10WD2N7	220~240/1N/50Hz	198	264	17.5	19	20	/	13	0.17	0.80
MHC-V12WD2N7	220~240/1N/50Hz	198	264	25	31	32	/	18	0.2	0.80
MHC-V14WD2N7	220~240/1N/50Hz	198	264	26.5	31	32	/	18	0.2	0.80
MHC-V16WD2N7	220~240/1N/50Hz	198	264	28	31	32	/	18	0.2	1.30
MHC-V12WD2RN7	380~415/3N/50Hz	342	456	8.5	11	16	/	18	0.2	0.57
MHC-V14WD2RN7	380~415/3N/50Hz	342	456	9	11	16	/	18	0.2	0.57
MHC-V16WD2RN7	380~415/3N/50Hz	342	456	9.5	11	16	/	18	0.2	1.25

Notes:

Name	Description	Explanation
Min. & Max.	Minimum&Maximum running voltage (V)	Required voltage range for system operation
MCA	Min. Circuit Amps. (A)	To determine the minimum wire diameter
TOCA	Total Over-current Amps. (A)	The maximum current for protecting system
MFA	Max. Fuse Amps. (A)	To determine air-break switch /circuit breaker/ Fuse
MSC	Max. Starting Amps. (A)	The starting current of the inverter compressor is very small and can be ignored.
RLA	Rated Load Amps. (A)	The input Amps of compressor where MAX. Hz can operate for nominal cooling or heating test condition
kW	Rated Motor Output	/
FLA	Full Load Amps. (A)	The current measured by the motor at rated voltage and rated speed (usually the highest speed of Motor) under rated load.

3 Dimensions and Center of Gravity

4-6kW

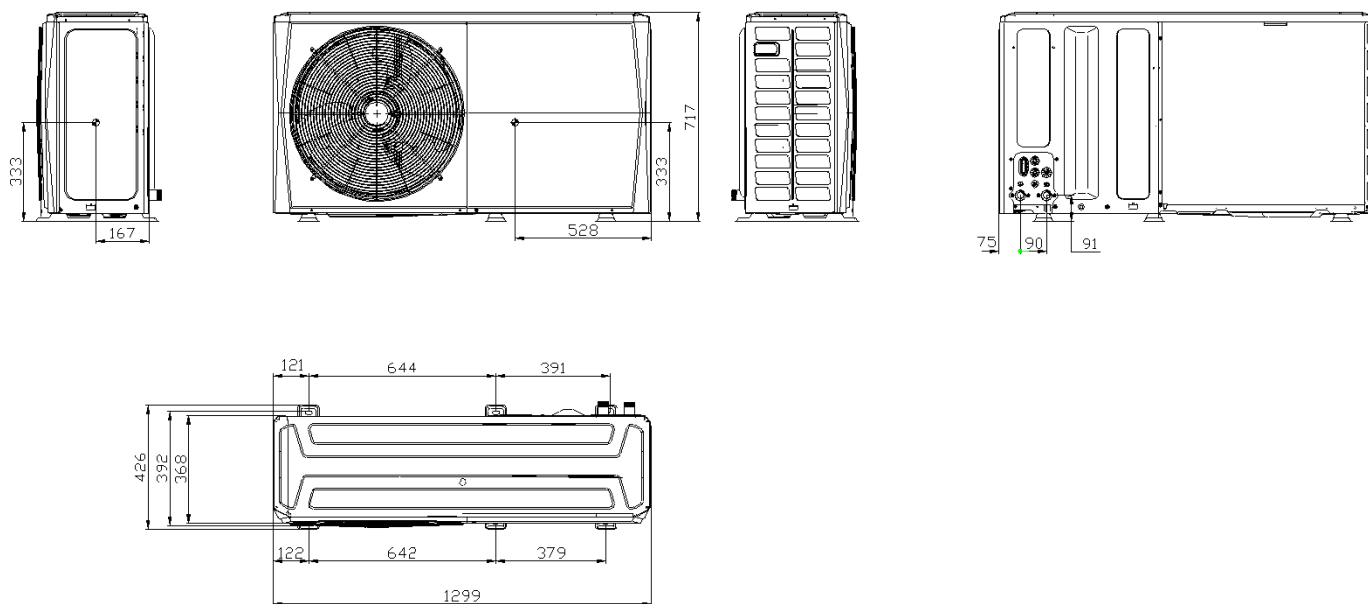

unit: mm

8-10kW

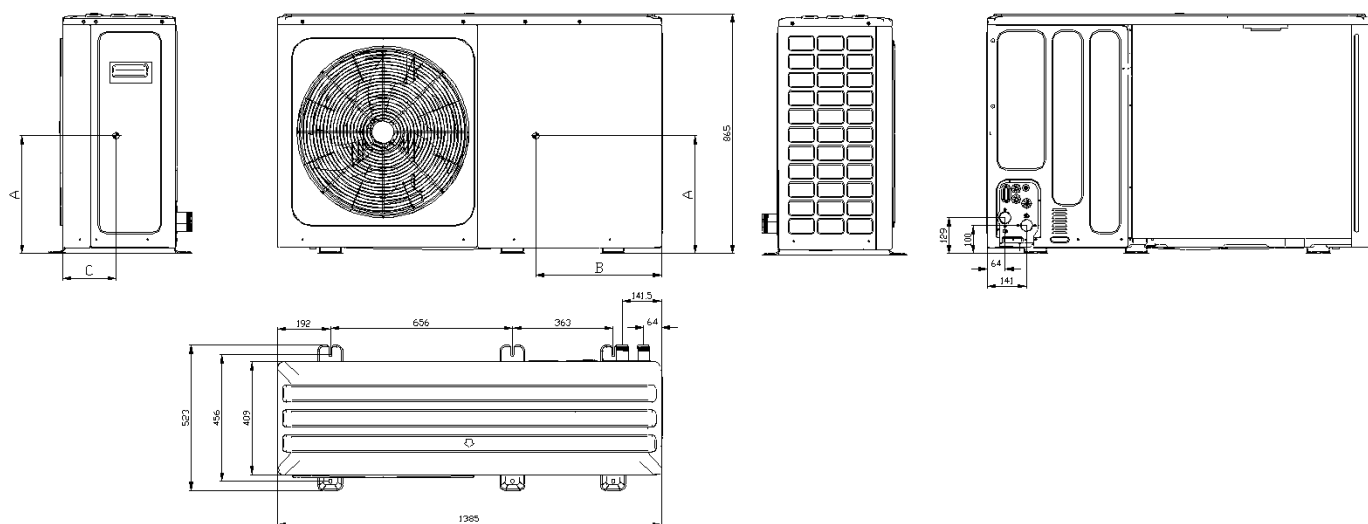

unit: mm

Model	A	B	C
1 phase 8/10kW	360	550	234
1 phase 12/14/16kW	415	715	200
3 phase 12/14/16kW			

4 Operating Limits

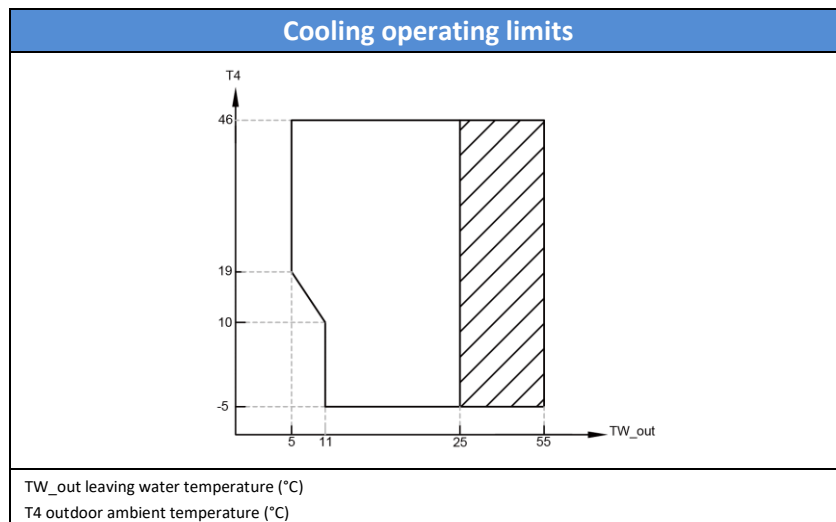
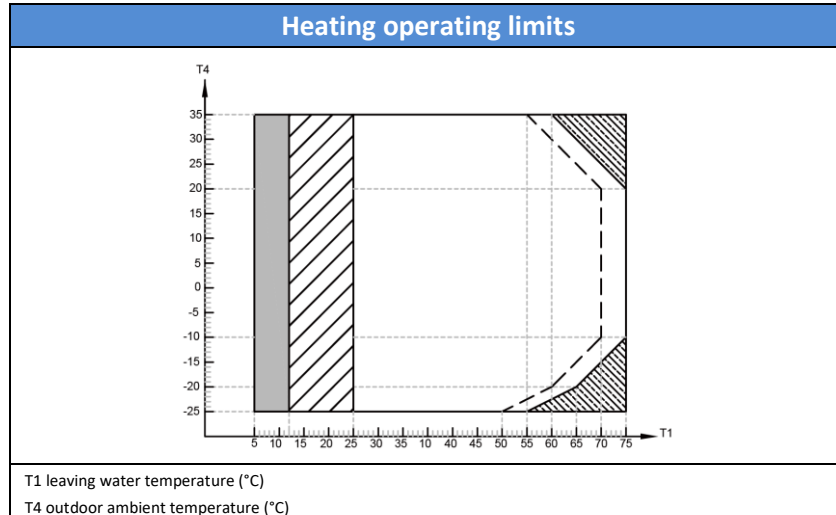

Notes:

1. If IBH/AHS setting is valid, only IBH/AHS turns on; If IBH/AHS setting is invalid, only heat pump turns on. Limitation and protection may occur during heat pump operation.
2. Operation range by heat pump with possible limitation and protection.
3. Heat pump turns off, only IBH/AHS on.
4. Maximum inlet water temperature line for heat pump operation.

Domestic hot water operating limits

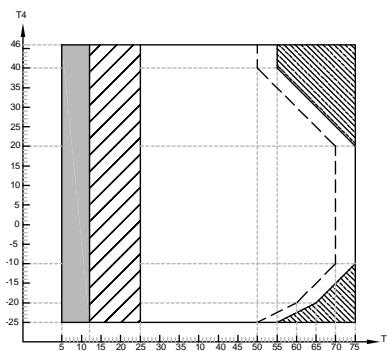

T1 leaving water temperature (°C)
T4 outdoor ambient temperature (°C)

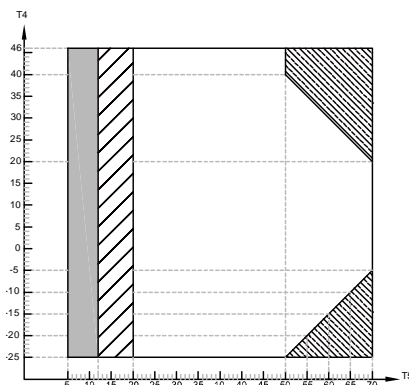

T5 DHW tank temperature(°C)
T4 outdoor ambient temperature (°C)

Notes:

5. If IBH/AHS setting is valid, only IBH/AHS turns on; If IBH/AHS setting is invalid, only heat pump turns on. Limitation and protection may occur during heat pump operation.
6. Operation range by heat pump with possible limitation and protection.
7. Heat pump turns off, only IBH/AHS on.
8. Maximum inlet water temperature line for heat pump operation.

5 Hydronic Performance

4-6kW hydronic performance¹

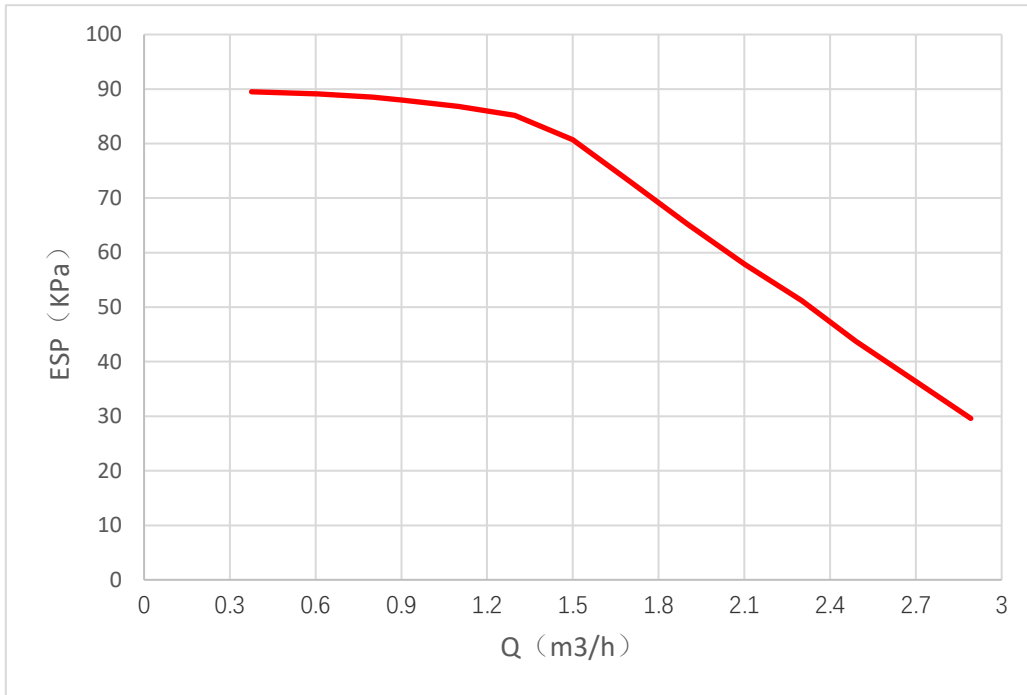

Abbreviations:
ESP: External static pressure

8-10kW hydronic performance¹

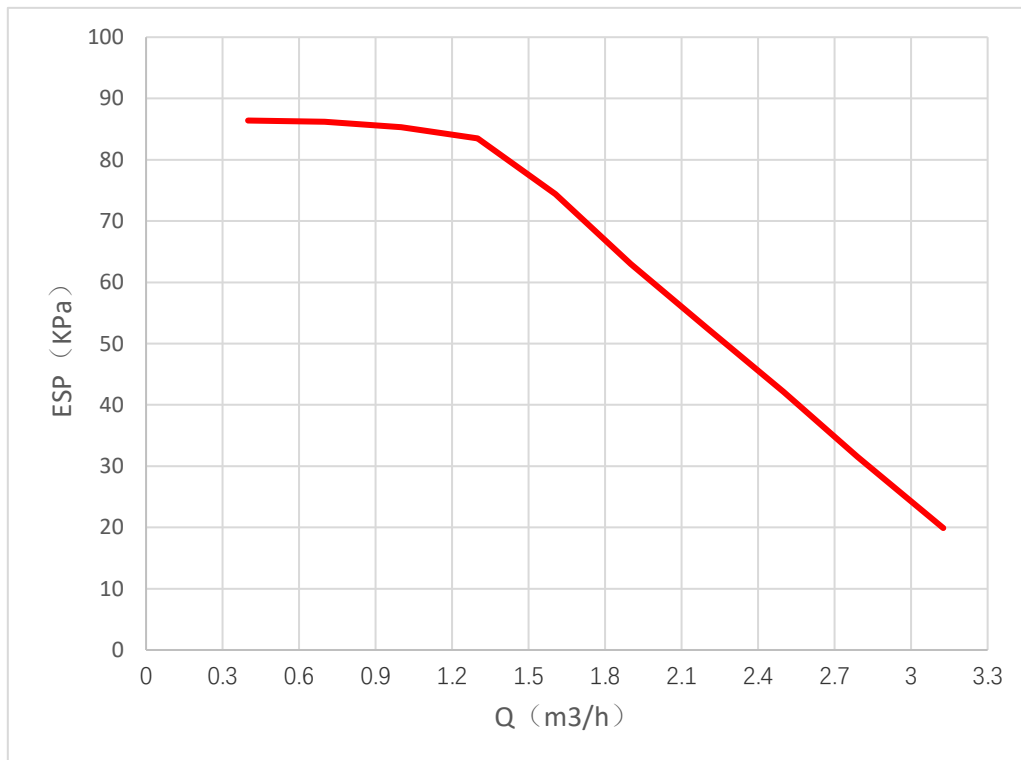

Abbreviations:
ESP: External static pressure

12-16kW hydronic performance¹

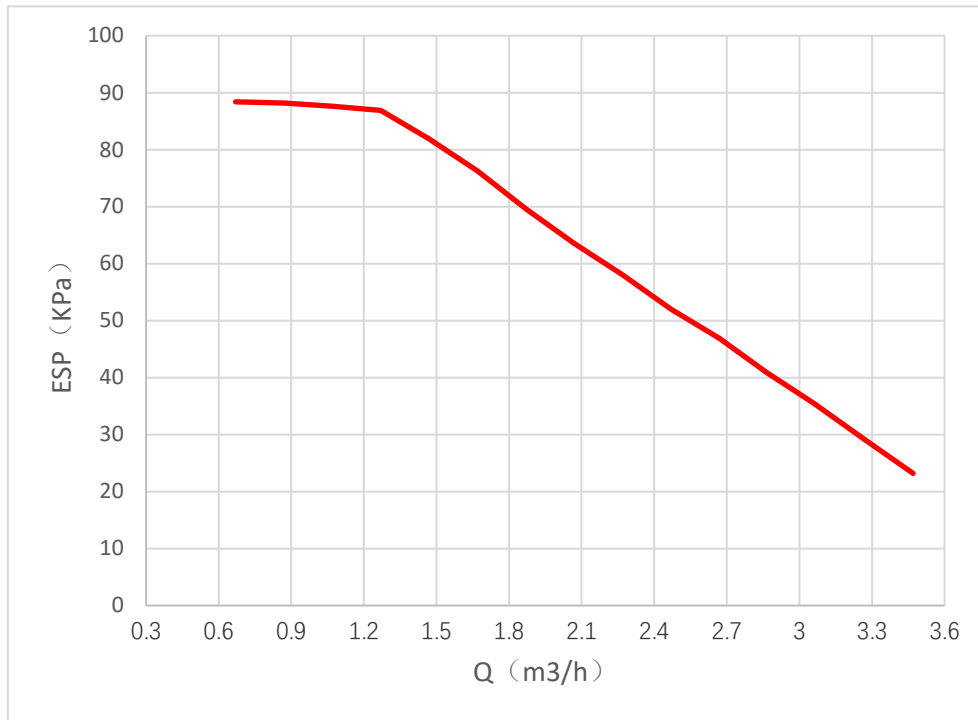

Abbreviations:
ESP: External static pressure

6 Capacity Tables

6.1 Heating Capacity Tables (Test standard: EN14511)

4kW Heating Capacity

LWT	DB	Maximum			100%(Nonimal)			75%			50%			25%			Minimum		
		HC	COP	PI	HC	COP	PI	HC	COP	PI	HC	COP	PI	HC	COP	PI	HC	COP	PI
25	-25	3.24	2.17	1.50	3.24	2.17	1.50	2.42	2.43	1.00	1.60	2.48	0.65	1.34	2.50	0.54	1.34	2.50	0.54
	-20	3.92	2.50	1.57	3.92	2.50	1.57	2.95	2.77	1.06	1.97	2.80	0.70	1.63	2.82	0.58	1.63	2.82	0.58
	-15	4.63	2.85	1.63	4.45	2.89	1.54	3.28	2.97	1.11	2.20	3.12	0.70	1.92	3.15	0.61	1.92	3.15	0.61
	-10	5.54	3.26	1.70	4.43	3.43	1.29	3.32	3.60	0.92	2.35	3.62	0.65	2.35	3.62	0.65	2.35	3.62	0.65
	-7	5.78	3.56	1.62	4.41	3.75	1.18	3.28	3.90	0.84	2.55	3.94	0.65	2.55	3.94	0.65	2.55	3.94	0.65
	-5	5.95	3.74	1.59	4.49	4.10	1.09	3.39	4.21	0.81	2.73	4.28	0.64	2.73	4.28	0.64	2.73	4.28	0.64
	-2	6.07	4.06	1.49	4.38	4.50	0.97	3.31	4.61	0.72	2.43	4.64	0.52	2.43	4.64	0.52	2.43	4.64	0.52
	0	6.16	4.32	1.43	4.42	4.78	0.92	3.37	4.90	0.69	2.59	4.97	0.52	2.59	4.97	0.52	2.59	4.97	0.52
	2	6.29	4.58	1.37	4.40	5.06	0.87	3.33	5.18	0.64	2.74	5.27	0.52	2.74	5.27	0.52	2.74	5.27	0.52
	5	6.80	5.31	1.28	4.38	5.86	0.75	3.28	6.02	0.54	2.79	6.08	0.46	2.79	6.08	0.46	2.79	6.08	0.46
	7	7.18	5.74	1.25	4.55	6.08	0.75	3.32	6.32	0.53	3.01	6.38	0.47	3.01	6.38	0.47	3.01	6.38	0.47
	10	7.04	6.25	1.13	4.46	6.89	0.65	3.34	7.17	0.47	3.34	7.17	0.47	3.34	7.17	0.47	3.34	7.17	0.47
	12	7.26	6.79	1.07	4.43	7.57	0.59	3.53	7.77	0.45	3.53	7.77	0.45	3.53	7.77	0.45	3.53	7.77	0.45
	15	6.90	7.25	0.95	4.42	7.88	0.56	3.62	8.14	0.44	3.62	8.14	0.44	3.62	8.14	0.44	3.62	8.14	0.44
	20	6.48	8.11	0.80	4.52	8.79	0.51	3.40	9.23	0.37	3.40	9.23	0.37	3.40	9.23	0.37	3.40	9.23	0.37
	25	6.42	9.45	0.68	4.44	10.23	0.43	3.75	10.57	0.35	3.75	10.57	0.35	3.75	10.57	0.35	3.75	10.57	0.35
30	/	/	/	/	/	/	/	/	/	/	/	/	/	/	/	/	/	/	/
35	/	/	/	/	/	/	/	/	/	/	/	/	/	/	/	/	/	/	/
LWT	DB	Maximum			100%(Nonimal)			75%			50%			25%			Minimum		
		HC	COP	PI	HC	COP	PI	HC	COP	PI	HC	COP	PI	HC	COP	PI	HC	COP	PI
30	-25	3.22	1.99	1.62	3.22	1.99	1.62	2.39	2.04	1.17	1.60	2.10	0.76	1.29	2.12	0.61	1.29	2.12	0.61
	-20	3.88	2.29	1.70	3.88	2.29	1.70	2.91	2.37	1.23	1.94	2.45	0.79	1.58	2.48	0.64	1.58	2.48	0.64
	-15	4.56	2.65	1.72	4.56	2.65	1.72	3.30	2.69	1.23	2.18	2.78	0.78	1.85	2.85	0.65	1.85	2.85	0.65
	-10	5.45	3.02	1.80	4.42	3.17	1.39	3.32	3.23	1.03	2.20	3.28	0.67	2.20	3.28	0.67	2.20	3.28	0.67
	-7	5.67	3.29	1.72	4.42	3.44	1.29	3.30	3.52	0.94	2.52	3.63	0.69	2.52	3.63	0.69	2.52	3.63	0.69
	-5	5.83	3.45	1.69	4.36	3.69	1.18	3.26	3.75	0.87	2.63	3.79	0.69	2.63	3.79	0.69	2.63	3.79	0.69
	-2	5.95	3.74	1.59	4.40	4.02	1.09	3.33	4.08	0.82	2.39	4.18	0.57	2.39	4.18	0.57	2.39	4.18	0.57
	0	6.04	3.97	1.52	4.42	4.19	1.05	3.31	4.30	0.77	2.49	4.38	0.57	2.49	4.38	0.57	2.49	4.38	0.57
	2	6.17	4.19	1.47	4.42	4.51	0.98	3.36	4.58	0.73	2.64	4.65	0.57	2.64	4.65	0.57	2.64	4.65	0.57
	5	6.66	4.84	1.38	4.36	5.15	0.85	3.26	5.25	0.62	2.79	5.37	0.52	2.79	5.37	0.52	2.79	5.37	0.52
	7	7.03	5.20	1.35	4.54	5.63	0.81	3.36	5.79	0.58	3.04	5.85	0.52	3.04	5.85	0.52	3.04	5.85	0.52
	10	7.18	5.81	1.24	4.44	6.34	0.70	3.33	6.44	0.52	3.20	6.46	0.50	3.20	6.46	0.50	3.20	6.46	0.50
	12	7.42	6.10	1.21	4.42	6.58	0.67	3.44	6.78	0.51	3.44	6.78	0.51	3.44	6.78	0.51	3.44	6.78	0.51
	15	6.74	6.37	1.06	4.53	6.80	0.67	3.50	7.02	0.50	3.50	7.02	0.50	3.50	7.02	0.50	3.50	7.02	0.50
	20	6.35	7.10	0.89	4.53	7.55	0.60	3.29	7.90	0.42	3.29	7.90	0.42	3.29	7.90	0.42	3.29	7.90	0.42
	25	6.31	8.18	0.77	4.44	8.78	0.51	3.62	9.07	0.40	3.62	9.07	0.40	3.62	9.07	0.40	3.62	9.07	0.40
30	6.63	9.33	0.71	4.44	9.61	0.46	3.98	9.77	0.41	3.98	9.77	0.41	3.98	9.77	0.41	3.98	9.77	0.41	
35	/	/	/	/	/	/	/	/	/	/	/	/	/	/	/	/	/	/	/
LWT	DB	Maximum			100%(Nonimal)			75%			50%			25%			Minimum		
		HC	COP	PI	HC	COP	PI	HC	COP	PI	HC	COP	PI	HC	COP	PI	HC	COP	PI
35	-25	3.19	1.86	1.71	3.19	1.86	1.71	2.40	1.92	1.26	1.58	2.01	0.79	1.24	2.05	0.61	1.24	2.05	0.61
	-20	3.82	2.14	1.79	3.82	2.14	1.79	2.87	2.18	1.31	1.92	2.28	0.84	1.52	2.32	0.65	1.52	2.32	0.65
	-15	4.47	2.46	1.82	4.42	2.40	1.84	3.31	2.49	1.33	2.20	2.64	0.83	1.79	2.66	0.67	1.79	2.66	0.67
	-10	5.35	2.81	1.90	4.42	2.86	1.55	3.27	2.97	1.10	2.18	3.08	0.71	2.18	3.08	0.71	2.18	3.08	0.71
	-7	5.56	3.04	1.83	4.50	3.10	1.45	3.32	3.12	1.06	2.36	3.21	0.73	2.36	3.21	0.73	2.36	3.21	0.73
	-5	5.70	3.18	1.80	4.37	3.32	1.32	3.30	3.37	0.98	2.53	3.43	0.74	2.53	3.43	0.74	2.53	3.43	0.74
	-2	5.82	3.44	1.69	4.27	3.58	1.19	3.18	3.67	0.87	2.31	3.74	0.62	2.31	3.74	0.62	2.31	3.74	0.62
	0	5.90	3.64	1.62	4.38	3.78	1.16	3.28	3.88	0.85	2.39	3.95	0.61	2.39	3.95	0.61	2.39	3.95	0.61
	2	6.05	3.84	1.57	4.40	4.10	1.07	3.34	4.14	0.81	2.53	4.19	0.60	2.53	4.19	0.60	2.53	4.19	0.60
	5	6.50	4.40	1.48	4.33	4.61	0.94	3.24	4.70	0.69	2.68	4.75	0.56	2.68	4.75	0.56	2.68	4.75	0.56
	7	6.86	4.72	1.46	4.50	5.15	0.87	3.34	5.25	0.64	2.93	5.32	0.55	2.93	5.32	0.55	2.93	5.32	0.55
	10	7.00	5.21	1.34	4.43	5.58	0.79	3.37	5.67	0.59	3.24	5.78	0.56	3.24	5.78	0.56	3.24	5.78	0.56
	12	7.23	5.59	1.29	4.49	6.01	0.75	3.48	6.14	0.57	3.45	6.22	0.56	3.45	6.22	0.56	3.45	6.22	0.56
	15	6.86	5.87	1.17	4.49	6.20	0.72	3.55	6.36	0.56	3.55	6.36	0.56	3.55	6.36	0.56	3.55	6.36	0.56
	20	6.20	6.23	0.99	4.52	6.52	0.69	3.17	6.66	0.48	3.17	6.66	0.48	3.17	6.66	0.48	3.17	6.66	0.48
	25	6.31	7.10	0.89	4.46	7.48	0.60	3.50	7.69	0.46	3.50	7.69	0.46	3.50	7.69	0.46	3.50	7.69	0.46
30	6.51	8.05	0.81	4.45	8.58	0.52	3.84	8.75	0.44	3.84	8.75	0.44	3.84	8.75	0.44	3.84	8.75	0.44	
35	6.76	9.10	0.74	4.40	10.04	0.44	4.20	10.05	0.42	4.20	10.05	0.42	4.20	10.05	0.42	4.20	10.05	0.42	

R290 M thermal Arctic HT Series



LWT	DB	Maximum			100%(Nonimal)			75%			50%			25%			Minimum		
		HC	COP	PI	HC	COP	PI	HC	COP	PI	HC	COP	PI	HC	COP	PI	HC	COP	PI
40	-25	3.15	1.79	1.76	3.15	1.79	1.76	2.36	1.84	1.29	1.56	1.94	0.81	1.26	1.95	0.65	1.26	1.95	0.65
	-20	3.77	2.04	1.85	3.77	2.04	1.85	2.83	2.08	1.36	1.89	2.19	0.87	1.54	2.22	0.69	1.54	2.22	0.69
	-15	4.38	2.29	1.92	4.38	2.29	1.92	3.27	2.32	1.41	2.17	2.43	0.89	1.82	2.46	0.74	1.82	2.46	0.74
	-10	5.22	2.63	1.99	4.50	2.65	1.70	3.40	2.69	1.26	2.26	2.73	0.83	2.16	2.75	0.79	2.16	2.75	0.79
	-7	5.44	2.81	1.94	4.50	2.89	1.56	3.34	2.97	1.13	2.39	3.07	0.78	2.39	3.07	0.78	2.39	3.07	0.78
	-5	5.59	2.93	1.91	4.45	3.02	1.47	3.31	3.06	1.08	2.56	3.20	0.80	2.56	3.20	0.80	2.56	3.20	0.80
	-2	5.70	3.17	1.80	4.29	3.28	1.31	3.22	3.34	0.97	2.57	3.36	0.76	2.57	3.36	0.76	2.57	3.36	0.76
	0	5.77	3.33	1.73	4.40	3.47	1.27	3.33	3.49	0.95	2.73	3.58	0.76	2.73	3.58	0.76	2.73	3.58	0.76
	2	5.92	3.52	1.68	4.40	3.64	1.21	3.33	3.70	0.90	2.90	3.75	0.77	2.90	3.75	0.77	2.90	3.75	0.77
	5	6.36	4.01	1.59	4.39	4.13	1.06	3.30	4.14	0.80	3.27	4.19	0.78	3.27	4.19	0.78	3.27	4.19	0.78
	7	6.71	4.28	1.57	4.49	4.46	1.01	3.58	4.52	0.79	3.58	4.52	0.79	3.58	4.52	0.79	3.58	4.52	0.79
	10	6.84	4.69	1.46	4.53	4.92	0.92	3.74	4.99	0.75	3.74	4.99	0.75	3.74	4.99	0.75	3.74	4.99	0.75
	12	7.05	5.00	1.41	4.47	5.27	0.85	3.99	5.30	0.75	3.99	5.30	0.75	3.99	5.30	0.75	3.99	5.30	0.75
	15	6.69	5.22	1.28	4.47	5.45	0.82	4.10	5.50	0.75	4.10	5.50	0.75	4.10	5.50	0.75	4.10	5.50	0.75
	20	6.33	5.75	1.10	4.45	5.94	0.75	3.70	5.98	0.62	3.70	5.98	0.62	3.70	5.98	0.62	3.70	5.98	0.62
	25	6.32	6.38	0.99	4.45	6.55	0.68	3.89	6.63	0.59	3.89	6.63	0.59	3.89	6.63	0.59	3.89	6.63	0.59
	30	6.35	6.98	0.91	4.46	7.27	0.61	4.28	7.36	0.58	4.28	7.36	0.58	4.28	7.36	0.58	4.28	7.36	0.58
35	6.60	7.97	0.83	4.71	8.17	0.58	4.71	8.17	0.58	4.71	8.17	0.58	4.71	8.17	0.58	4.71	8.17	0.58	
45	-25	3.10	1.68	1.84	3.10	1.68	1.84	2.32	1.71	1.35	1.54	1.80	0.85	1.41	1.83	0.77	1.41	1.83	0.77
	-20	3.69	1.91	1.94	3.69	1.91	1.94	2.78	1.93	1.44	1.83	2.03	0.90	1.71	2.05	0.83	1.71	2.05	0.83
	-15	4.28	2.12	2.02	4.28	2.12	2.02	3.23	2.17	1.49	2.15	2.27	0.95	2.01	2.31	0.87	2.01	2.31	0.87
	-10	5.11	2.49	2.05	4.63	2.51	1.84	3.45	2.55	1.35	2.39	2.60	0.92	2.39	2.60	0.92	2.39	2.60	0.92
	-7	5.31	2.58	2.05	4.70	2.70	1.74	3.41	2.75	1.24	2.65	2.80	0.94	2.65	2.80	0.94	2.65	2.80	0.94
	-5	5.46	2.70	2.02	4.51	2.81	1.61	3.40	2.88	1.18	2.85	2.89	0.99	2.85	2.89	0.99	2.85	2.89	0.99
	-2	5.55	2.90	1.91	4.36	3.02	1.44	3.32	3.05	1.09	2.74	3.08	0.89	2.74	3.08	0.89	2.74	3.08	0.89
	0	5.64	3.06	1.85	4.46	3.20	1.39	3.38	3.38	1.00	2.92	3.48	0.84	2.92	3.48	0.84	2.92	3.48	0.84
	2	5.77	3.21	1.80	4.40	3.35	1.31	3.35	3.52	0.95	3.10	3.55	0.87	3.10	3.55	0.87	3.10	3.55	0.87
	5	6.19	3.48	1.78	4.50	3.72	1.21	3.50	3.74	0.94	3.50	3.74	0.94	3.50	3.74	0.94	3.50	3.74	0.94
	7	6.55	3.79	1.73	4.50	4.05	1.11	3.82	4.10	0.93	3.82	4.10	0.93	3.82	4.10	0.93	3.82	4.10	0.93
	10	6.66	4.10	1.62	4.49	4.37	1.03	4.02	4.41	0.91	4.02	4.41	0.91	4.02	4.41	0.91	4.02	4.41	0.91
	12	6.87	4.25	1.62	4.43	4.64	0.96	4.30	4.71	0.91	4.30	4.71	0.91	4.30	4.71	0.91	4.30	4.71	0.91
	15	6.51	4.50	1.45	4.44	4.79	0.93	4.41	4.85	0.91	4.41	4.85	0.91	4.41	4.85	0.91	4.41	4.85	0.91
	20	6.14	4.95	1.24	4.43	5.18	0.85	4.04	5.28	0.77	4.04	5.28	0.77	4.04	5.28	0.77	4.04	5.28	0.77
	25	6.14	5.71	1.07	4.50	5.79	0.78	4.46	5.87	0.76	4.46	5.87	0.76	4.46	5.87	0.76	4.46	5.87	0.76
	30	6.47	6.35	1.02	4.96	6.45	0.77	4.92	6.54	0.75	4.92	6.54	0.75	4.92	6.54	0.75	4.92	6.54	0.75
35	6.44	6.76	0.95	5.20	6.88	0.76	5.16	6.94	0.74	5.16	6.94	0.74	5.16	6.94	0.74	5.16	6.94	0.74	
50	-25	3.03	1.58	1.92	3.03	1.58	1.92	2.27	1.61	1.41	1.52	1.66	0.92	1.52	1.66	0.92	1.52	1.66	0.92
	-20	3.61	1.78	2.03	3.61	1.78	2.03	2.69	1.81	1.48	1.81	1.88	0.96	1.81	1.88	0.96	1.81	1.88	0.96
	-15	4.16	1.96	2.12	4.16	1.96	2.12	3.12	1.99	1.57	2.12	2.06	1.03	2.12	2.06	1.03	2.12	2.06	1.03
	-10	4.96	2.22	2.24	4.61	2.28	2.02	3.45	2.32	1.49	2.52	2.37	1.06	2.52	2.37	1.06	2.52	2.37	1.06
	-7	5.17	2.38	2.17	4.64	2.42	1.92	3.41	2.50	1.37	2.77	2.55	1.09	2.77	2.55	1.09	2.77	2.55	1.09
	-5	5.31	2.47	2.15	4.51	2.57	1.75	3.41	2.60	1.31	2.99	2.63	1.13	2.99	2.63	1.13	2.99	2.63	1.13
	-2	5.41	2.66	2.04	4.43	2.71	1.64	3.33	2.74	1.22	3.04	2.79	1.09	3.04	2.79	1.09	3.04	2.79	1.09
	0	5.50	2.80	1.97	4.54	2.90	1.56	3.43	2.87	1.19	3.24	2.94	1.10	3.24	2.94	1.10	3.24	2.94	1.10
	2	5.63	2.96	1.90	4.50	3.00	1.50	3.40	3.03	1.12	3.40	3.03	1.12	3.40	3.03	1.12	3.40	3.03	1.12
	5	6.02	3.20	1.88	4.44	3.34	1.33	3.90	3.34	1.17	3.90	3.34	1.17	3.90	3.34	1.17	3.90	3.34	1.17
	7	6.35	3.51	1.81	4.57	3.54	1.29	4.26	3.58	1.19	4.26	3.58	1.19	4.26	3.58	1.19	4.26	3.58	1.19
	10	6.46	3.79	1.70	4.54	3.90	1.16	4.30	3.92	1.10	4.30	3.92	1.10	4.30	3.92	1.10	4.30	3.92	1.10
	12	6.69	4.03	1.66	4.63	4.12	1.13	4.60	4.16	1.11	4.60	4.16	1.11	4.60	4.16	1.11	4.60	4.16	1.11
	15	6.31	4.17	1.51	4.77	4.25	1.12	4.73	4.29	1.10	4.73	4.29	1.10	4.73	4.29	1.10	4.73	4.29	1.10
	20	5.95	4.51	1.32	4.51	4.55	0.99	4.13	4.59	0.90	4.13	4.59	0.90	4.13	4.59	0.90	4.13	4.59	0.90
	25	5.95	4.98	1.19	4.61	5.06	0.91	4.56	5.08	0.90	4.56	5.08	0.90	4.56	5.08	0.90	4.56	5.08	0.90
	30	6.26	5.46	1.15	5.08	5.70	0.89	5.03	5.71	0.88	5.03	5.71	0.88	5.03	5.71	0.88	5.03	5.71	0.88
35	6.53	6.05	1.08	5.58	6.16	0.91	5.54	6.22	0.89	5.54	6.22	0.89	5.54	6.22	0.89	5.54	6.22	0.89	
55	-25	2.87	1.44	2.00	2.87	1.44	2.00	2.15	1.46	1.47	1.55	1.50	1.03	1.55	1.50	1.03	1.55	1.50	1.03
	-20	3.33	1.59	2.10	3.33	1.59	2.10	2.56	1.65	1.55	1.87	1.69	1.11	1.87	1.69	1.11	1.87	1.69	1.11
	-15	3.93	1.77	2.22	3.93	1.77	2.22	2.93	1.81	1.62	2.19	1.85	1.18	2.19	1.85	1.18	2.19	1.85	1.18
	-10	4.66	1.98	2.36	4.60	1.99	2.32	3.44	2.00	1.72	2.59	2.04	1.27	2.59	2.04	1.27	2.59	2.04	1.27
	-7	4.85	2.14	2.27	4.70	2.15	2.19	3.41	2.17	1.57	2.86	2.20	1.30	2.86	2.20	1.30	2.86	2.20	1.30
	-5	5.00	2.22	2.25	4.55	2.25	2.02	3.42	2.28	1.50	3.07	2.30	1.33	3.07	2.30	1.33	3.07	2.30	1.33
	-2	5.11	2.37	2.16	4.46	2.50	1.78	3.35	2.51	1.33	3.25	2.57	1.27	3.25	2.57	1.27	3.25	2.57	1.27
	0	5.37	2.58	2.08	4.61	2.61	1.76	3.49	2.65	1.32	3.49	2.65	1.32	3.49	2.65	1.32	3.49	2.65	1.32
	2	5.50	2.70	2.04	4.60	2.70	1.70	3.67	2.73	1.34	3.67	2.73	1.34	3.67	2.73	1.34	3.67	2.73	1.34
	5	5.88	2.98	1.97	4.48	3.03	1.48	4.17	3.05	1.37	4.17	3.05	1.37	4.17	3.05	1.37	4.17	3.05	1.37
	7	6.20	3.10	2.00	4.60	3.20	1.44	4.55	3.23	1.41	4.55	3.23	1.41	4.55	3.23	1.41	4.55	3.23	1.41
	10	6.32	3.38	1.87	4.59	3.45	1.33	4.26	3.53	1.21	4.26	3.53	1.21	4.26	3.53	1.21	4.26	3.53	1.21
	12	6.50	3.55	1.83	4.69	3.69	1.27	4.55	3.74	1.22	4.55	3.74	1.22	4.55	3.74	1.22	4.55	3.74	1.22
	15	6.15	3.77	1.63	4.83	3.80	1.27	4.68	3.85	1.22	4.68	3.85	1.22	4.68	3.85	1.22	4.68	3.85	1.22
	20	5.78	4.04	1.43	4.60	4.10	1.12	4.11	4.07	1.01	4.11	4.07	1.01	4.11	4.07	1.01	4.11	4.07	1.01
	2																		

LWT	DB	Maximum			100%(Nonimal)			75%			50%			25%			Minimum		
		HC	COP	PI	HC	COP	PI	HC	COP	PI	HC	COP	PI	HC	COP	PI	HC	COP	PI
60	-25	/	/	/	/	/	/	/	/	/	/	/	/	/	/	/	/	/	/
	-20	3.29	1.49	2.21	3.29	1.49	2.21	2.47	1.52	1.63	1.94	1.53	1.27	1.94	1.53	1.27	1.94	1.53	1.27
	-15	3.78	1.62	2.34	3.78	1.62	2.34	2.83	1.66	1.70	2.27	1.69	1.35	2.27	1.69	1.35	2.27	1.69	1.35
	-10	4.47	1.80	2.49	4.47	1.80	2.49	3.43	1.84	1.86	2.67	1.86	1.43	2.67	1.86	1.43	2.67	1.86	1.43
	-7	4.68	1.93	2.43	4.61	1.93	2.39	3.45	1.96	1.76	2.94	1.99	1.48	2.94	1.99	1.48	2.94	1.99	1.48
	-5	4.82	2.00	2.40	4.58	2.03	2.26	3.47	2.10	1.65	3.16	2.13	1.48	3.16	2.13	1.48	3.16	2.13	1.48
	-2	4.93	2.16	2.29	4.44	2.28	1.95	3.34	2.32	1.44	3.10	2.36	1.31	3.10	2.36	1.31	3.10	2.36	1.31
	0	5.20	2.34	2.22	4.41	2.35	1.88	3.31	2.42	1.37	3.31	2.42	1.37	3.31	2.42	1.37	3.31	2.42	1.37
	2	5.32	2.44	2.18	4.37	2.51	1.74	3.50	2.55	1.37	3.50	2.55	1.37	3.50	2.55	1.37	3.50	2.55	1.37
	5	5.67	2.73	2.08	4.56	2.80	1.63	3.97	2.84	1.40	3.97	2.84	1.40	3.97	2.84	1.40	3.97	2.84	1.40
	7	5.97	2.89	2.07	4.58	2.94	1.56	4.34	2.98	1.46	4.34	2.98	1.46	4.34	2.98	1.46	4.34	2.98	1.46
	10	6.06	3.02	2.01	4.57	3.10	1.47	4.22	3.15	1.34	4.22	3.15	1.34	4.22	3.15	1.34	4.22	3.15	1.34
	12	6.26	3.09	2.03	4.66	3.24	1.44	4.51	3.27	1.38	4.51	3.27	1.38	4.51	3.27	1.38	4.51	3.27	1.38
	15	5.91	3.35	1.77	4.79	3.39	1.41	4.65	3.43	1.35	4.65	3.43	1.35	4.65	3.43	1.35	4.65	3.43	1.35
	20	5.52	3.56	1.55	4.62	3.66	1.26	3.91	3.70	1.06	3.91	3.70	1.06	3.91	3.70	1.06	3.91	3.70	1.06
	25	5.48	3.88	1.41	4.60	3.92	1.17	4.32	3.97	1.09	4.32	3.97	1.09	4.32	3.97	1.09	4.32	3.97	1.09
30	5.78	4.17	1.39	4.95	4.25	1.17	4.78	4.28	1.11	4.78	4.28	1.11	4.78	4.28	1.11	4.78	4.28	1.11	
35	/	/	/	/	/	/	/	/	/	/	/	/	/	/	/	/	/	/	/
65	-25	/	/	/	/	/	/	/	/	/	/	/	/	/	/	/	/	/	/
	-20	3.14	1.36	2.31	3.14	1.36	2.31	2.35	1.37	1.71	1.86	1.39	1.34	1.86	1.39	1.34	1.86	1.39	1.34
	-15	3.61	1.47	2.45	3.61	1.47	2.45	2.72	1.51	1.81	2.16	1.51	1.43	2.16	1.51	1.43	2.16	1.51	1.43
	-10	4.26	1.62	2.62	4.26	1.62	2.62	3.19	1.67	1.91	2.55	1.69	1.51	2.55	1.69	1.51	2.55	1.69	1.51
	-7	4.44	1.73	2.57	4.44	1.73	2.57	3.42	1.77	1.94	2.79	1.79	1.56	2.79	1.79	1.56	2.79	1.79	1.56
	-5	4.61	1.81	2.55	4.55	1.83	2.48	3.43	1.86	1.84	3.00	1.88	1.59	3.00	1.88	1.59	3.00	1.88	1.59
	-2	4.93	2.03	2.43	4.46	2.09	2.14	3.38	2.14	1.58	2.91	2.15	1.36	2.91	2.15	1.36	2.91	2.15	1.36
	0	4.98	2.11	2.36	4.37	2.14	2.04	3.29	2.18	1.51	3.11	2.20	1.41	3.11	2.20	1.41	3.11	2.20	1.41
	2	5.11	2.16	2.37	4.31	2.19	1.96	3.29	2.22	1.48	3.29	2.22	1.48	3.29	2.22	1.48	3.29	2.22	1.48
	5	5.42	2.40	2.26	4.51	2.43	1.86	3.74	2.46	1.52	3.74	2.46	1.52	3.74	2.46	1.52	3.74	2.46	1.52
	7	5.71	2.55	2.24	4.63	2.57	1.80	4.10	2.59	1.58	4.10	2.59	1.58	4.10	2.59	1.58	4.10	2.59	1.58
	10	5.80	2.70	2.15	4.58	2.75	1.67	3.94	2.80	1.41	3.94	2.80	1.41	3.94	2.80	1.41	3.94	2.80	1.41
	12	5.98	2.83	2.11	4.58	2.85	1.60	4.21	2.89	1.46	4.21	2.89	1.46	4.21	2.89	1.46	4.21	2.89	1.46
	15	5.62	2.89	1.94	4.60	2.93	1.57	4.33	2.97	1.46	4.33	2.97	1.46	4.33	2.97	1.46	4.33	2.97	1.46
	20	5.19	3.09	1.68	4.64	3.15	1.47	3.66	3.17	1.16	3.66	3.17	1.16	3.66	3.17	1.16	3.66	3.17	1.16
	25	5.12	3.29	1.56	4.55	3.38	1.34	4.05	3.41	1.19	4.05	3.41	1.19	4.05	3.41	1.19	4.05	3.41	1.19
30	5.40	3.58	1.51	4.66	3.70	1.26	4.47	3.75	1.19	4.47	3.75	1.19	4.47	3.75	1.19	4.47	3.75	1.19	
35	/	/	/	/	/	/	/	/	/	/	/	/	/	/	/	/	/	/	/
70	-25	/	/	/	/	/	/	/	/	/	/	/	/	/	/	/	/	/	/
	-20	/	/	/	/	/	/	/	/	/	/	/	/	/	/	/	/	/	/
	-15	3.46	1.35	2.57	3.46	1.35	2.57	2.05	1.48	1.39	2.05	1.48	1.39	2.05	1.48	1.39	2.05	1.48	1.39
	-10	4.06	1.47	2.77	4.06	1.47	2.77	2.54	1.57	1.62	2.54	1.57	1.62	2.54	1.57	1.62	2.54	1.57	1.62
	-7	4.25	1.57	2.71	4.25	1.57	2.71	3.19	1.64	1.95	2.83	1.63	1.74	2.83	1.63	1.74	2.83	1.63	1.74
	-5	4.42	1.64	2.69	4.42	1.64	2.69	3.09	1.75	1.76	2.77	1.79	1.55	2.77	1.79	1.55	2.77	1.79	1.55
	-2	4.75	1.85	2.57	4.46	1.89	2.35	3.38	2.03	1.67	2.69	2.13	1.26	2.69	2.13	1.26	2.69	2.13	1.26
	0	4.84	1.93	2.50	4.38	1.95	2.25	3.29	2.09	1.57	2.88	2.16	1.33	2.88	2.16	1.33	2.88	2.16	1.33
	2	4.96	2.01	2.46	4.31	2.07	2.08	3.24	2.22	1.46	3.05	2.25	1.36	3.05	2.25	1.36	3.05	2.25	1.36
	5	5.26	2.23	2.36	4.50	2.29	1.96	3.38	2.40	1.41	3.38	2.40	1.41	3.38	2.40	1.41	3.38	2.40	1.41
	7	5.52	2.33	2.37	4.64	2.40	1.93	3.80	2.51	1.51	3.80	2.51	1.51	3.80	2.51	1.51	3.80	2.51	1.51
	10	5.59	2.48	2.26	4.56	2.55	1.79	3.60	2.71	1.33	3.60	2.71	1.33	3.60	2.71	1.33	3.60	2.71	1.33
	12	5.77	2.55	2.26	4.64	2.68	1.73	3.85	2.83	1.36	3.85	2.83	1.36	3.85	2.83	1.36	3.85	2.83	1.36
	15	5.37	2.63	2.05	4.66	2.70	1.72	3.96	2.87	1.38	3.96	2.87	1.38	3.96	2.87	1.38	3.96	2.87	1.38
	20	4.92	2.75	1.79	4.68	2.80	1.67	3.36	2.93	1.15	3.36	2.93	1.15	3.36	2.93	1.15	3.36	2.93	1.15
	25	4.78	2.85	1.68	4.58	2.87	1.60	3.72	2.97	1.25	3.72	2.97	1.25	3.72	2.97	1.25	3.72	2.97	1.25
30	/	/	/	/	/	/	/	/	/	/	/	/	/	/	/	/	/	/	/
35	/	/	/	/	/	/	/	/	/	/	/	/	/	/	/	/	/	/	/
75	-25	/	/	/	/	/	/	/	/	/	/	/	/	/	/	/	/	/	/
	-20	/	/	/	/	/	/	/	/	/	/	/	/	/	/	/	/	/	/
	-15	/	/	/	/	/	/	/	/	/	/	/	/	/	/	/	/	/	/
	-10	3.74	1.28	2.93	3.74	1.28	2.93	2.88	1.37	2.10	2.22	1.48	1.50	2.22	1.48	1.50	2.22	1.48	1.50
	-7	3.93	1.37	2.86	3.93	1.37	2.86	2.95	1.41	2.09	2.40	1.51	1.59	2.40	1.51	1.59	2.40	1.51	1.59
	-5	4.12	1.44	2.86	4.12	1.44	2.86	3.10	1.50	2.07	2.71	1.57	1.73	2.71	1.57	1.73	2.71	1.57	1.73
	-2	4.42	1.62	2.74	4.42	1.62	2.74	3.39	1.67	2.04	2.42	1.81	1.34	2.42	1.81	1.34	2.42	1.81	1.34
	0	4.52	1.70	2.66	4.52	1.70	2.66	3.41	1.74	1.96	2.59	1.86	1.39	2.59	1.86	1.39	2.59	1.86	1.39
	2	4.64	1.77	2.63	4.64	1.77	2.63	3.47	1.80	1.93	2.74	1.90	1.44	2.74	1.90	1.44	2.74	1.90	1.44
	5	4.90	1.94	2.52	4.50	1.97	2.28	3.33	2.18	1.53	3.09	2.20	1.41	3.09	2.20	1.41	3.09	2.20	1.41
	7	5.15	2.04	2.53	4.65	2.10	2.22	3.45	2.28	1.51	3.45	2.28	1.51	3.45	2.28	1.51	3.45	2.28	1.51
	10	5.19	2.15	2.42	4.60	2.21	2.08	3.47	2.45	1.42	3.47	2.45	1.42	3.47	2.45	1.42	3.47	2.45	1.42
	12	5.35	2.24	2.38	4.54	2.31	1.96	3.45	2.48	1.39	3.45	2.48	1.39	3.45	2.48	1.39	3.45	2.48	1.39
	15	4.94	2.25	2.20	4.66	2.32	2.01	3.47	2.52	1.38	3.47	2.52	1.38	3.47	2.52	1.38	3.47	2.52	1.38
	20	4.38	2.40	1.82	4.38	2.40	1.82	3.26	2.60	1.26	2.96	2.63	1.13	2.96	2.63	1.13	2.96	2.63	1.13
	25	/	/	/	/	/	/	/	/	/	/	/	/	/	/	/	/	/	/
30	/	/	/	/	/	/	/	/	/	/	/	/	/	/	/	/	/	/	/
35	/	/	/	/	/	/	/	/	/	/	/	/	/	/	/	/	/	/	/

Abbreviations:

LWT: Leaving water temperature (°C)

DB: Dry-bulb temperature for Outdoor air temperature (°C)

HC: Total heating capacity (kW)

PI: Power input (kW)

R290 M thermal Arctic HT Series



6kW Heating Capacity

LWT	DB	Maximum			100%(Nonimal)			75%			50%			25%			Minimum		
		HC	COP	PI	HC	COP	PI	HC	COP	PI	HC	COP	PI	HC	COP	PI	HC	COP	PI
25	-25	3.50	2.14	1.64	3.50	2.14	1.64	2.64	2.40	1.10	1.75	2.47	0.71	1.34	2.50	0.54	1.34	2.50	0.54
	-20	4.35	2.41	1.80	4.35	2.41	1.80	3.26	2.72	1.20	2.18	2.80	0.78	1.63	2.82	0.58	1.63	2.82	0.58
	-15	5.18	2.77	1.87	5.18	2.77	1.87	3.89	2.91	1.34	2.63	2.98	0.88	1.92	3.15	0.61	1.92	3.15	0.61
	-10	6.08	3.16	1.92	5.83	3.21	1.81	4.34	3.48	1.25	2.90	3.61	0.80	2.35	3.62	0.65	2.35	3.62	0.65
	-7	6.36	3.41	1.86	5.79	3.56	1.63	4.32	3.78	1.14	2.90	3.92	0.74	2.55	3.94	0.65	2.55	3.94	0.65
	-5	6.55	3.59	1.83	5.66	3.85	1.47	4.25	4.14	1.03	2.83	4.27	0.66	2.73	4.28	0.64	2.73	4.28	0.64
	-2	6.84	3.87	1.77	5.47	4.28	1.28	4.18	4.52	0.93	2.83	4.62	0.61	2.43	4.64	0.52	2.43	4.64	0.52
	0	6.99	4.10	1.70	5.66	4.49	1.26	4.29	4.79	0.90	2.78	4.91	0.57	2.59	4.97	0.52	2.59	4.97	0.52
	2	7.09	4.34	1.64	5.65	4.78	1.18	4.22	5.09	0.83	2.85	5.20	0.55	2.74	5.27	0.52	2.74	5.27	0.52
	5	7.72	5.06	1.53	5.85	5.65	1.03	4.41	5.85	0.75	2.90	6.07	0.48	2.79	6.08	0.46	2.79	6.08	0.46
	7	8.00	5.50	1.45	6.24	5.92	1.05	4.68	6.07	0.77	3.14	6.35	0.49	3.01	6.38	0.47	3.01	6.38	0.47
	10	7.95	5.89	1.35	6.24	6.55	0.95	4.62	6.87	0.67	3.34	7.17	0.47	3.34	7.17	0.47	3.34	7.17	0.47
	12	8.16	6.40	1.27	6.16	7.14	0.86	4.57	7.53	0.61	3.53	7.77	0.45	3.53	7.77	0.45	3.53	7.77	0.45
	15	7.92	6.79	1.17	6.27	7.39	0.85	4.65	7.81	0.60	3.62	8.14	0.44	3.62	8.14	0.44	3.62	8.14	0.44
	20	7.56	7.89	0.96	6.25	8.21	0.76	4.64	8.76	0.53	3.40	9.23	0.37	3.40	9.23	0.37	3.40	9.23	0.37
	25	7.12	9.21	0.77	6.30	9.54	0.66	4.71	10.02	0.47	3.75	10.57	0.35	3.75	10.57	0.35	3.75	10.57	0.35
30	/	/	/	/	/	/	/	/	/	/	/	/	/	/	/	/	/	/	/
35	/	/	/	/	/	/	/	/	/	/	/	/	/	/	/	/	/	/	/
30	-25	3.46	1.89	1.83	3.46	1.89	1.83	2.59	2.02	1.28	1.73	2.06	0.84	1.29	2.12	0.61	1.29	2.12	0.61
	-20	4.30	2.25	1.91	4.30	2.25	1.91	3.23	2.36	1.37	2.15	2.40	0.90	1.58	2.48	0.64	1.58	2.48	0.64
	-15	5.11	2.58	1.98	5.11	2.58	1.98	3.83	2.66	1.44	2.56	2.71	0.94	1.85	2.85	0.65	1.85	2.85	0.65
	-10	6.00	2.96	2.03	5.77	2.98	1.94	4.34	3.22	1.35	2.91	3.27	0.89	2.20	3.28	0.67	2.20	3.28	0.67
	-7	6.27	3.19	1.97	5.76	3.29	1.75	4.33	3.49	1.24	2.92	3.56	0.82	2.52	3.63	0.69	2.52	3.63	0.69
	-5	6.45	3.34	1.93	5.68	3.51	1.62	4.26	3.72	1.15	2.87	3.76	0.76	2.63	3.79	0.69	2.63	3.79	0.69
	-2	6.73	3.59	1.87	5.48	3.90	1.41	4.13	4.03	1.02	2.80	4.13	0.68	2.39	4.18	0.57	2.39	4.18	0.57
	0	6.87	3.79	1.81	5.66	4.08	1.39	4.29	4.21	1.02	2.85	4.34	0.66	2.49	4.38	0.57	2.49	4.38	0.57
	2	6.96	4.00	1.74	5.65	4.31	1.31	4.28	4.53	0.95	2.89	4.62	0.63	2.64	4.65	0.57	2.64	4.65	0.57
	5	7.58	4.64	1.63	5.87	4.99	1.18	4.36	5.15	0.85	2.91	5.28	0.55	2.79	5.37	0.52	2.79	5.37	0.52
	7	7.85	5.04	1.56	6.18	5.42	1.14	4.66	5.61	0.83	3.04	5.85	0.52	3.04	5.85	0.52	3.04	5.85	0.52
	10	8.16	5.59	1.46	6.22	6.04	1.03	4.59	6.21	0.74	3.20	6.46	0.50	3.20	6.46	0.50	3.20	6.46	0.50
	12	8.35	6.00	1.39	6.23	6.23	1.00	4.68	6.54	0.71	3.44	6.78	0.51	3.44	6.78	0.51	3.44	6.78	0.51
	15	7.74	6.05	1.28	6.25	6.45	0.97	4.64	6.78	0.68	3.50	7.02	0.50	3.50	7.02	0.50	3.50	7.02	0.50
	20	7.38	6.90	1.07	6.23	7.14	0.87	4.64	7.54	0.62	3.29	7.90	0.42	3.29	7.90	0.42	3.29	7.90	0.42
	25	7.04	7.95	0.89	6.31	8.18	0.77	4.65	8.71	0.53	3.62	9.07	0.40	3.62	9.07	0.40	3.62	9.07	0.40
30	7.07	9.19	0.77	6.17	9.24	0.67	4.65	9.56	0.49	3.98	9.77	0.41	3.98	9.77	0.41	3.98	9.77	0.41	
35	/	/	/	/	/	/	/	/	/	/	/	/	/	/	/	/	/	/	/
35	-25	3.40	1.76	1.94	3.40	1.76	1.94	2.56	1.91	1.34	1.74	1.94	0.89	1.24	2.05	0.61	1.24	2.05	0.61
	-20	4.24	2.10	2.01	4.24	2.10	2.01	3.18	2.15	1.48	2.12	2.21	0.96	1.52	2.32	0.65	1.52	2.32	0.65
	-15	5.05	2.43	2.08	5.05	2.43	2.08	3.79	2.46	1.54	2.53	2.51	1.01	1.79	2.66	0.67	1.79	2.66	0.67
	-10	5.91	2.77	2.13	5.81	2.78	2.09	4.34	2.94	1.48	2.93	2.98	0.98	2.18	3.08	0.71	2.18	3.08	0.71
	-7	6.18	2.93	2.11	5.90	2.95	2.00	4.34	3.11	1.39	2.89	3.14	0.92	2.36	3.21	0.73	2.36	3.21	0.73
	-5	6.36	3.12	2.04	5.70	3.20	1.78	4.28	3.36	1.27	2.89	3.41	0.85	2.53	3.43	0.74	2.53	3.43	0.74
	-2	6.61	3.32	1.99	5.51	3.55	1.55	4.16	3.62	1.15	2.76	3.69	0.75	2.31	3.74	0.62	2.31	3.74	0.62
	0	6.75	3.49	1.93	5.64	3.73	1.51	4.28	3.84	1.11	2.84	3.92	0.73	2.39	3.95	0.61	2.39	3.95	0.61
	2	6.83	3.67	1.86	5.60	3.90	1.44	4.17	4.12	1.01	2.76	4.18	0.66	2.53	4.19	0.60	2.53	4.19	0.60
	5	7.42	4.26	1.74	5.92	4.48	1.32	4.37	4.60	0.95	2.89	4.72	0.61	2.68	4.75	0.56	2.68	4.75	0.56
	7	7.70	4.61	1.67	6.20	4.90	1.27	4.64	5.12	0.91	3.15	5.26	0.60	2.93	5.32	0.55	2.93	5.32	0.55
	10	8.00	5.08	1.57	6.19	5.36	1.15	4.69	5.56	0.84	3.24	5.78	0.56	3.24	5.78	0.56	3.24	5.78	0.56
	12	8.17	5.43	1.50	6.24	5.77	1.08	4.63	5.97	0.78	3.45	6.22	0.56	3.45	6.22	0.56	3.45	6.22	0.56
	15	7.92	5.66	1.40	6.25	5.96	1.05	4.62	6.18	0.75	3.55	6.36	0.56	3.55	6.36	0.56	3.55	6.36	0.56
	20	7.53	6.21	1.21	5.97	6.30	0.95	4.62	6.51	0.71	3.17	6.66	0.48	3.17	6.66	0.48	3.17	6.66	0.48
	25	6.96	6.92	1.01	6.31	7.10	0.89	4.59	7.43	0.62	3.50	7.69	0.46	3.50	7.69	0.46	3.50	7.69	0.46
30	6.94	7.95	0.87	6.17	8.10	0.76	4.59	8.55	0.54	3.98	8.74	0.46	3.84	8.75	0.44	3.84	8.75	0.44	
35	7.12	9.07	0.79	6.14	9.51	0.65	4.73	9.88	0.48	4.20	10.05	0.42	4.20	10.05	0.42	4.20	10.05	0.42	
40	-25	3.34	1.65	2.03	3.34	1.65	2.03	2.51	1.82	1.38	1.73	1.86	0.93	1.26	1.95	0.65	1.26	1.95	0.65
	-20	4.17	1.98	2.11	4.17	1.98	2.11	3.20	2.06	1.55	2.08	2.09	1.00	1.54	2.22	0.69	1.54	2.22	0.69
	-15	4.96	2.21	2.24	4.96	2.21	2.24	3.72	2.31	1.61	2.48	2.33	1.06	1.82	2.46	0.74	1.82	2.46	0.74
	-10	5.83	2.53	2.30	5.60	2.61	2.15	4.21	2.67	1.58	2.82	2.72	1.04	2.16	2.75	0.79	2.16	2.75	0.79
	-7	6.07	2.78	2.19	5.59	2.79	2.00	4.22	2.92	1.44	2.77	3.01	0.92	2.39	3.07	0.78	2.39	3.07	0.78
	-5	6.22	2.88	2.16	5.56	2.94	1.89	4.22	3.04	1.39	2.79	3.07	0.91	2.56	3.20	0.80	2.56	3.20	0.80
	-2	6.48	3.06	2.11	5.45	3.24	1.68	4.11	3.33	1.24	2.80	3.35	0.83	2.57	3.36	0.76	2.57	3.36	0.76
	0	6.58	3.20	2.06	5.70	3.39	1.68	4.29	3.48	1.23	2.92	3.50	0.83	2.73	3.58	0.76	2.73	3.58	0.76
	2	6.69	3.38	1.98	5.74	3.57	1.61	4.40	3.64	1.21	2.90	3.75	0.77	2.90	3.75	0.77	2.90	3.75	0.77
	5	7.25	3.89	1.86	5.94	4.04	1.47	4.42	4.11	1.07	3.27	4.19	0.78	3.27	4.19	0.78	3.27	4.19	0.78
	7	7.53	4.20	1.79	6.35	4.31	1.47	4.70	4.40	1.07	3.58	4.52	0.79	3.58	4.52	0.79	3.58	4.52	0.79
	10	7.82	4.61	1.69	6.33	4.76	1.33	4.66	4.89	0.95	3.74	4.99	0.75	3.74	4.99	0.75	3.74	4.99	0.75
	12	8.00	4.91	1.63	6.30	5.10	1.24	4.73	5.23	0.90	3.99	5.30	0.75	3.99	5.30	0.75	3.99	5.30	0.75
	15	7.73	5.10	1.52	6.30	5.25	1.20	4.70	5.43	0.87	4.10	5.50	0.75	4.10	5.50	0.75	4.10	5.50	0.75
	20	7.35	5.62	1.31	6.33	5.75	1.10	4.70	5.86	0.80	3.70	5.98	0.62	3.70	5.98	0.62	3.70	5.98	0.62
	25	6.98	6.24	1.12	6.32	6.38	0.99	4.70	6.50	0.72	4.00	6.60	0.61	3.89	6.63	0.59	3.89	6.	

LWT	DB	Maximum			100%(Nonimal)			75%			50%			25%			Minimum		
		HC	COP	PI	HC	COP	PI	HC	COP	PI	HC	COP	PI	HC	COP	PI	HC	COP	PI
45	-25	3.28	1.55	2.11	3.28	1.55	2.11	2.46	1.69	1.45	1.76	1.73	1.02	1.41	1.83	0.77	1.41	1.83	0.77
	-20	4.08	1.86	2.20	4.08	1.86	2.20	2.99	1.93	1.55	2.04	1.94	1.05	1.71	2.05	0.83	1.71	2.05	0.83
	-15	4.88	2.08	2.34	4.88	2.08	2.34	3.66	2.16	1.69	2.44	2.19	1.11	2.01	2.31	0.87	2.01	2.31	0.87
	-10	5.71	2.36	2.41	5.42	2.42	2.24	4.02	2.53	1.59	2.69	2.56	1.05	2.39	2.60	0.92	2.39	2.60	0.92
	-7	5.95	2.48	2.40	5.50	2.50	2.20	4.01	2.73	1.47	2.73	2.77	0.99	2.65	2.80	0.94	2.65	2.80	0.94
	-5	6.08	2.67	2.28	5.43	2.71	2.00	4.10	2.85	1.44	2.85	2.89	0.99	2.85	2.89	0.99	2.85	2.89	0.99
	-2	6.32	2.81	2.25	5.47	2.90	1.88	4.13	3.01	1.37	2.74	3.08	0.89	2.74	3.08	0.89	2.74	3.08	0.89
	0	6.44	2.95	2.19	5.74	3.05	1.88	4.35	3.17	1.37	2.92	3.48	0.84	2.92	3.48	0.84	2.92	3.48	0.84
	2	6.53	3.09	2.11	5.80	3.10	1.87	4.35	3.38	1.29	3.10	3.55	0.87	3.10	3.55	0.87	3.10	3.55	0.87
	5	7.07	3.40	2.08	6.06	3.60	1.68	4.54	3.63	1.25	3.65	3.65	1.00	3.50	3.74	0.94	3.50	3.74	0.94
	7	7.35	3.65	2.01	6.40	3.80	1.68	4.74	3.92	1.21	3.99	4.00	1.00	3.82	4.10	0.93	3.82	4.10	0.93
	10	7.63	4.02	1.90	6.47	4.24	1.53	4.83	4.31	1.12	4.02	4.41	0.91	4.02	4.41	0.91	4.02	4.41	0.91
	12	7.79	4.30	1.81	6.35	4.53	1.40	4.83	4.60	1.05	4.30	4.71	0.91	4.30	4.71	0.91	4.30	4.71	0.91
	15	7.52	4.42	1.70	6.51	4.66	1.40	4.83	4.72	1.02	4.41	4.85	0.91	4.41	4.85	0.91	4.41	4.85	0.91
	20	7.14	4.85	1.47	6.50	5.04	1.29	4.81	5.11	0.94	4.04	5.28	0.77	4.04	5.28	0.77	4.04	5.28	0.77
	25	6.78	5.61	1.21	6.41	5.68	1.13	4.78	5.73	0.83	4.46	5.87	0.76	4.46	5.87	0.76	4.46	5.87	0.76
	30	6.91	6.31	1.10	6.47	6.35	1.02	4.92	6.54	0.75	4.92	6.54	0.75	4.92	6.54	0.75	4.92	6.54	0.75
35	6.78	6.75	1.01	6.44	6.76	0.95	5.16	6.94	0.74	5.16	6.94	0.74	5.16	6.94	0.74	5.16	6.94	0.74	
50	-25	3.20	1.46	2.19	3.20	1.46	2.19	2.40	1.60	1.50	1.85	1.62	1.14	1.52	1.66	0.92	1.52	1.66	0.92
	-20	3.98	1.74	2.29	3.98	1.74	2.29	2.99	1.79	1.67	1.99	1.85	1.08	1.81	1.88	0.96	1.81	1.88	0.96
	-15	4.75	1.90	2.50	4.75	1.90	2.50	3.56	1.98	1.80	2.37	2.00	1.19	2.12	2.06	1.03	2.12	2.06	1.03
	-10	5.57	2.13	2.62	5.23	2.16	2.42	3.96	2.30	1.72	2.52	2.37	1.06	2.52	2.37	1.06	2.52	2.37	1.06
	-7	5.80	2.28	2.55	5.26	2.29	2.30	3.95	2.46	1.61	2.77	2.55	1.09	2.77	2.55	1.09	2.77	2.55	1.09
	-5	5.94	2.46	2.41	5.29	2.49	2.12	4.03	2.58	1.56	2.99	2.63	1.13	2.99	2.63	1.13	2.99	2.63	1.13
	-2	6.17	2.59	2.38	5.37	2.67	2.01	4.06	2.72	1.49	3.04	2.79	1.09	3.04	2.79	1.09	3.04	2.79	1.09
	0	6.28	2.70	2.33	5.69	2.79	2.04	4.32	2.85	1.51	3.24	2.94	1.10	3.24	2.94	1.10	3.24	2.94	1.10
	2	6.37	2.83	2.25	5.74	2.88	1.99	4.36	2.99	1.46	3.40	3.03	1.12	3.40	3.03	1.12	3.40	3.03	1.12
	5	6.92	3.12	2.22	5.96	3.21	1.85	4.44	3.30	1.34	3.90	3.34	1.17	3.90	3.34	1.17	3.90	3.34	1.17
	7	7.00	3.44	2.04	6.29	3.40	1.85	4.69	3.52	1.33	4.26	3.58	1.19	4.26	3.58	1.19	4.26	3.58	1.19
	10	7.28	3.71	1.96	6.28	3.72	1.69	4.76	3.88	1.23	4.30	3.92	1.10	4.30	3.92	1.10	4.30	3.92	1.10
	12	7.44	3.92	1.90	6.37	3.98	1.60	4.63	4.12	1.13	4.60	4.16	1.11	4.60	4.16	1.11	4.60	4.16	1.11
	15	7.19	4.04	1.78	6.42	4.15	1.55	4.77	4.25	1.12	4.73	4.29	1.10	4.73	4.29	1.10	4.73	4.29	1.10
	20	6.80	4.37	1.56	6.42	4.40	1.46	4.76	4.54	1.05	4.13	4.59	0.90	4.13	4.59	0.90	4.13	4.59	0.90
	25	6.59	4.90	1.34	6.34	4.93	1.29	4.75	5.04	0.94	4.56	5.08	0.90	4.56	5.08	0.90	4.56	5.08	0.90
	30	6.57	5.42	1.21	6.41	5.50	1.17	5.03	5.71	0.88	5.03	5.71	0.88	5.03	5.71	0.88	5.03	5.71	0.88
35	6.75	6.00	1.13	6.21	6.12	1.01	5.55	6.19	0.90	5.54	6.22	0.89	5.54	6.22	0.89	5.54	6.22	0.89	
55	-25	3.00	1.40	2.14	3.00	1.40	2.14	2.25	1.44	1.56	1.55	1.50	1.03	1.55	1.50	1.03	1.55	1.50	1.03
	-20	3.66	1.57	2.34	3.66	1.57	2.34	2.77	1.63	1.70	1.87	1.69	1.11	1.87	1.69	1.11	1.87	1.69	1.11
	-15	4.46	1.71	2.61	4.46	1.71	2.61	3.34	1.79	1.87	2.19	1.85	1.18	2.19	1.85	1.18	2.19	1.85	1.18
	-10	5.23	1.91	2.74	5.12	1.92	2.67	3.81	1.99	1.92	2.59	2.04	1.27	2.59	2.04	1.27	2.59	2.04	1.27
	-7	5.47	2.13	2.57	5.02	2.14	2.35	3.74	2.16	1.73	2.86	2.20	1.30	2.86	2.20	1.30	2.86	2.20	1.30
	-5	5.59	2.15	2.60	5.17	2.20	2.35	3.88	2.27	1.71	3.07	2.30	1.33	3.07	2.30	1.33	3.07	2.30	1.33
	-2	5.81	2.30	2.53	5.28	2.35	2.24	4.01	2.51	1.60	3.25	2.57	1.27	3.25	2.57	1.27	3.25	2.57	1.27
	0	6.16	2.50	2.46	5.34	2.60	2.06	4.04	2.63	1.53	3.49	2.65	1.32	3.49	2.65	1.32	3.49	2.65	1.32
	2	6.22	2.60	2.39	5.80	2.65	2.19	4.41	2.72	1.62	3.67	2.73	1.34	3.67	2.73	1.34	3.67	2.73	1.34
	5	6.72	2.88	2.33	5.99	2.95	2.03	4.42	3.04	1.46	4.17	3.05	1.37	4.17	3.05	1.37	4.17	3.05	1.37
	7	6.97	3.00	2.32	6.20	3.10	2.00	4.72	3.19	1.48	4.55	3.23	1.41	4.55	3.23	1.41	4.55	3.23	1.41
	10	7.24	3.32	2.18	6.22	3.40	1.83	4.59	3.48	1.32	4.26	3.53	1.21	4.26	3.53	1.21	4.26	3.53	1.21
	12	7.40	3.52	2.10	6.20	3.58	1.73	4.69	3.69	1.27	4.55	3.74	1.22	4.55	3.74	1.22	4.55	3.74	1.22
	15	7.14	3.67	1.95	6.25	3.72	1.68	4.83	3.80	1.27	4.68	3.85	1.22	4.68	3.85	1.22	4.68	3.85	1.22
	20	6.77	3.95	1.71	6.24	3.98	1.57	4.60	4.06	1.13	4.11	4.07	1.01	4.11	4.07	1.01	4.11	4.07	1.01
	25	6.39	4.32	1.48	6.26	4.35	1.44	4.71	4.51	1.04	4.56	4.55	1.00	4.56	4.55	1.00	4.56	4.55	1.00
	30	6.50	4.72	1.38	6.22	4.75	1.31	5.03	4.91	1.02	5.03	4.91	1.02	5.03	4.91	1.02	5.03	4.91	1.02
35	6.69	4.95	1.35	6.18	4.98	1.24	5.54	5.08	1.09	5.54	5.08	1.09	5.54	5.08	1.09	5.54	5.08	1.09	
60	-25	/	/	/	/	/	/	/	/	/	/	/	/	/	/	/	/	/	/
	-20	3.60	1.41	2.55	3.60	1.41	2.55	2.70	1.50	1.81	1.94	1.53	1.27	1.94	1.53	1.27	1.94	1.53	1.27
	-15	4.31	1.60	2.70	4.31	1.60	2.70	3.23	1.65	1.97	2.27	1.69	1.35	2.27	1.69	1.35	2.27	1.69	1.35
	-10	5.05	1.78	2.83	5.05	1.78	2.83	3.83	1.83	2.10	2.67	1.86	1.43	2.67	1.86	1.43	2.67	1.86	1.43
	-7	5.27	1.84	2.87	5.10	1.86	2.74	3.79	1.94	1.95	2.94	1.99	1.48	2.94	1.99	1.48	2.94	1.99	1.48
	-5	5.39	1.90	2.84	5.15	1.91	2.70	3.93	2.05	1.92	3.16	2.13	1.48	3.16	2.13	1.48	3.16	2.13	1.48
	-2	5.61	2.01	2.79	5.29	2.04	2.60	3.99	2.29	1.74	3.10	2.36	1.31	3.10	2.36	1.31	3.10	2.36	1.31
	0	5.92	2.17	2.73	5.66	2.22	2.55	4.29	2.36	1.82	3.31	2.42	1.37	3.31	2.42	1.37	3.31	2.42	1.37
	2	6.01	2.26	2.66	5.44	2.34	2.32	4.10	2.52	1.63	3.50	2.55	1.37	3.50	2.55	1.37	3.50	2.55	1.37
	5	6.49	2.59	2.51	5.96	2.65	2.25	4.41	2.81	1.57	3.97	2.84	1.40	3.97	2.84	1.40	3.97	2.84	1.40
	7	6.75	2.80	2.41	6.20	2.82	2.20	4.58	2.94	1.56	4.34	2.98	1.46	4.34	2.98	1.46	4.34	2.98	1.46
	10	7.00	2.95	2.37	6.21	2.98	2.08	4.69	3.09	1.5									

R290 M thermal Arctic HT Series



LWT	DB	Maximum			100%(Nonimal)			75%			50%			25%			Minimum		
		HC	COP	PI	HC	COP	PI	HC	COP	PI	HC	COP	PI	HC	COP	PI	HC	COP	PI
65	-25	/	/	/	/	/	/	/	/	/	/	/	/	/	/	/	/	/	/
	-20	3.44	1.29	2.66	3.44	1.29	2.66	2.58	1.37	1.89	1.86	1.39	1.34	1.86	1.39	1.34	1.86	1.39	1.34
	-15	4.12	1.38	2.99	4.12	1.38	2.99	3.09	1.50	2.06	2.16	1.51	1.43	2.16	1.51	1.43	2.16	1.51	1.43
	-10	4.83	1.56	3.10	4.83	1.56	3.10	3.61	1.65	2.18	2.55	1.69	1.51	2.55	1.69	1.51	2.55	1.69	1.51
	-7	5.05	1.69	2.99	5.05	1.69	2.99	3.81	1.73	2.20	2.79	1.79	1.56	2.79	1.79	1.56	2.79	1.79	1.56
	-5	4.93	1.76	2.80	4.93	1.76	2.80	3.77	1.84	2.05	3.00	1.88	1.59	3.00	1.88	1.59	3.00	1.88	1.59
	-2	5.31	1.89	2.81	5.31	1.89	2.81	4.02	2.12	1.89	2.91	2.15	1.36	2.91	2.15	1.36	2.91	2.15	1.36
	0	5.68	1.96	2.90	5.35	1.99	2.68	4.05	2.17	1.87	3.11	2.20	1.41	3.11	2.20	1.41	3.11	2.20	1.41
	2	5.78	2.04	2.84	5.41	2.07	2.61	4.13	2.20	1.88	3.29	2.22	1.48	3.29	2.22	1.48	3.29	2.22	1.48
	5	6.23	2.30	2.71	5.96	2.32	2.57	4.44	2.43	1.83	3.74	2.46	1.52	3.74	2.46	1.52	3.74	2.46	1.52
	7	6.46	2.45	2.64	6.19	2.47	2.51	4.63	2.57	1.80	4.10	2.59	1.58	4.10	2.59	1.58	4.10	2.59	1.58
	10	6.68	2.60	2.57	6.22	2.63	2.37	4.58	2.75	1.67	3.94	2.80	1.41	3.94	2.80	1.41	3.94	2.80	1.41
	12	6.82	2.72	2.51	6.20	2.75	2.25	4.58	2.85	1.60	4.21	2.89	1.46	4.21	2.89	1.46	4.21	2.89	1.46
	15	6.57	2.80	2.35	6.25	2.82	2.22	4.72	2.90	1.63	4.33	2.97	1.46	4.33	2.97	1.46	4.33	2.97	1.46
	20	6.18	3.05	2.03	6.18	3.05	2.03	4.64	3.15	1.47	3.66	3.17	1.16	3.66	3.17	1.16	3.66	3.17	1.16
	25	5.74	3.27	1.76	5.74	3.27	1.76	4.55	3.38	1.34	4.05	3.41	1.19	4.05	3.41	1.19	4.05	3.41	1.19
30	5.78	3.55	1.63	5.78	3.55	1.63	4.66	3.70	1.26	4.47	3.75	1.19	4.47	3.75	1.19	4.47	3.75	1.19	
35	/	/	/	/	/	/	/	/	/	/	/	/	/	/	/	/	/	/	/
70	-25	/	/	/	/	/	/	/	/	/	/	/	/	/	/	/	/	/	/
	-20	/	/	/	/	/	/	/	/	/	/	/	/	/	/	/	/	/	/
	-15	3.96	1.30	3.04	3.96	1.30	3.04	2.97	1.38	2.16	2.05	1.48	1.39	2.05	1.48	1.39	2.05	1.48	1.39
	-10	4.18	1.39	3.00	4.18	1.39	3.00	3.13	1.48	2.12	2.54	1.57	1.62	2.54	1.57	1.62	2.54	1.57	1.62
	-7	4.48	1.48	3.03	4.48	1.48	3.03	3.44	1.59	2.16	2.83	1.63	1.74	2.83	1.63	1.74	2.83	1.63	1.74
	-5	4.50	1.54	2.91	4.50	1.54	2.91	3.62	1.65	2.19	2.77	1.79	1.55	2.77	1.79	1.55	2.77	1.79	1.55
	-2	5.13	1.70	3.01	5.13	1.70	3.01	4.01	1.93	2.08	2.69	2.13	1.26	2.69	2.13	1.26	2.69	2.13	1.26
	0	5.35	1.76	3.04	5.35	1.76	3.04	4.05	1.98	2.04	2.88	2.16	1.33	2.88	2.16	1.33	2.88	2.16	1.33
	2	5.44	1.83	2.97	5.44	1.83	2.97	4.12	2.10	1.96	3.05	2.25	1.36	3.05	2.25	1.36	3.05	2.25	1.36
	5	5.92	1.95	3.04	5.92	1.95	3.04	4.44	2.20	2.02	3.38	2.40	1.41	3.38	2.40	1.41	3.38	2.40	1.41
	7	6.27	2.23	2.81	6.27	2.23	2.81	4.64	2.40	1.93	3.80	2.51	1.51	3.80	2.51	1.51	3.80	2.51	1.51
	10	6.19	2.38	2.60	6.19	2.38	2.60	4.68	2.49	1.88	3.60	2.71	1.33	3.60	2.71	1.33	3.60	2.71	1.33
	12	6.18	2.48	2.49	6.18	2.48	2.49	4.64	2.68	1.73	3.85	2.83	1.36	3.85	2.83	1.36	3.85	2.83	1.36
	15	6.34	2.52	2.52	6.34	2.52	2.52	4.66	2.70	1.72	3.96	2.87	1.38	3.96	2.87	1.38	3.96	2.87	1.38
	20	5.94	2.59	2.29	5.94	2.59	2.29	4.45	2.81	1.58	3.36	2.93	1.15	3.36	2.93	1.15	3.36	2.93	1.15
	25	5.41	2.72	1.99	5.41	2.72	1.99	4.06	2.91	1.39	3.72	2.97	1.25	3.72	2.97	1.25	3.72	2.97	1.25
30	/	/	/	/	/	/	/	/	/	/	/	/	/	/	/	/	/	/	/
35	/	/	/	/	/	/	/	/	/	/	/	/	/	/	/	/	/	/	/
75	-25	/	/	/	/	/	/	/	/	/	/	/	/	/	/	/	/	/	/
	-20	/	/	/	/	/	/	/	/	/	/	/	/	/	/	/	/	/	/
	-15	/	/	/	/	/	/	/	/	/	/	/	/	/	/	/	/	/	/
	-10	3.81	1.26	3.02	3.81	1.26	3.02	2.88	1.37	2.10	2.22	1.48	1.50	2.22	1.48	1.50	2.22	1.48	1.50
	-7	4.09	1.29	3.17	4.09	1.29	3.17	3.07	1.39	2.20	2.40	1.51	1.59	2.40	1.51	1.59	2.40	1.51	1.59
	-5	4.60	1.34	3.43	4.60	1.34	3.43	3.47	1.48	2.34	2.71	1.57	1.73	2.71	1.57	1.73	2.71	1.57	1.73
	-2	4.67	1.50	3.11	4.67	1.50	3.11	3.54	1.63	2.17	2.42	1.81	1.34	2.42	1.81	1.34	2.42	1.81	1.34
	0	5.06	1.51	3.34	5.06	1.51	3.34	3.83	1.72	2.22	2.59	1.86	1.39	2.59	1.86	1.39	2.59	1.86	1.39
	2	5.17	1.58	3.27	5.17	1.58	3.27	3.92	1.78	2.20	2.74	1.90	1.44	2.74	1.90	1.44	2.74	1.90	1.44
	5	5.60	1.80	3.11	5.60	1.80	3.11	4.20	1.99	2.11	3.09	2.20	1.41	3.09	2.20	1.41	3.09	2.20	1.41
	7	5.84	1.95	3.00	5.84	1.95	3.00	4.38	2.11	2.08	3.45	2.28	1.51	3.45	2.28	1.51	3.45	2.28	1.51
	10	6.03	2.00	3.02	6.03	2.00	3.02	4.52	2.23	2.03	3.47	2.45	1.42	3.47	2.45	1.42	3.47	2.45	1.42
	12	6.12	2.12	2.89	6.12	2.12	2.89	4.69	2.29	2.05	3.45	2.48	1.39	3.45	2.48	1.39	3.45	2.48	1.39
	15	5.91	2.20	2.69	5.91	2.20	2.69	4.50	2.34	1.92	3.47	2.52	1.38	3.47	2.52	1.38	3.47	2.52	1.38
	20	5.46	2.22	2.46	5.46	2.22	2.46	4.09	2.42	1.69	2.96	2.63	1.13	2.96	2.63	1.13	2.96	2.63	1.13
	25	/	/	/	/	/	/	/	/	/	/	/	/	/	/	/	/	/	/
30	/	/	/	/	/	/	/	/	/	/	/	/	/	/	/	/	/	/	/
35	/	/	/	/	/	/	/	/	/	/	/	/	/	/	/	/	/	/	/

Abbreviations:

LWT: Leaving water temperature (°C)

DB: Dry-bulb temperature for Outdoor air temperature (°C)

HC: Total heating capacity (kW)

PI: Power input (kW)

8kW Heating Capacity

LWT	DB	Maximum			100%(Nonimal)			75%			50%			25%			Minimum		
		HC	COP	PI	HC	COP	PI	HC	COP	PI	HC	COP	PI	HC	COP	PI	HC	COP	PI
25	-25	5.15	2.16	2.39	5.15	2.16	2.39	3.86	2.49	1.55	2.57	2.79	0.92	2.19	2.85	0.77	2.19	2.85	0.77
	-20	6.00	2.46	2.44	6.00	2.46	2.44	4.63	2.70	1.71	3.09	3.01	1.02	2.61	3.10	0.84	2.61	3.10	0.84
	-15	7.43	2.86	2.60	7.13	2.88	2.47	5.15	3.10	1.66	3.43	3.50	0.98	3.05	3.56	0.85	3.05	3.56	0.85
	-10	8.61	3.07	2.80	7.01	3.65	1.92	5.38	3.83	1.41	3.65	4.23	0.86	3.36	4.25	0.79	3.36	4.25	0.79
	-7	8.93	3.41	2.62	6.95	3.81	1.83	5.29	4.03	1.31	3.80	4.42	0.86	3.80	4.42	0.86	3.80	4.42	0.86
	-5	9.07	3.61	2.51	7.03	4.02	1.75	5.27	4.35	1.21	4.07	4.62	0.88	4.07	4.62	0.88	4.07	4.62	0.88
	-2	9.34	3.97	2.35	7.10	4.42	1.60	5.40	4.82	1.12	3.64	5.25	0.69	3.64	5.25	0.69	3.64	5.25	0.69
	0	9.29	4.16	2.24	7.08	4.69	1.51	5.39	4.98	1.08	3.82	5.31	0.72	3.82	5.31	0.72	3.82	5.31	0.72
	2	9.42	4.46	2.11	7.11	5.02	1.42	5.41	5.32	1.02	4.03	5.71	0.71	4.03	5.71	0.71	4.03	5.71	0.71
	5	10.18	5.39	1.89	7.66	5.89	1.30	5.77	6.27	0.92	4.23	6.52	0.65	4.23	6.52	0.65	4.23	6.52	0.65
	7	10.76	5.84	1.84	8.28	6.53	1.27	6.25	6.95	0.90	4.62	7.15	0.65	4.62	7.15	0.65	4.62	7.15	0.65
	10	11.16	6.79	1.64	8.36	7.50	1.12	6.25	7.84	0.80	5.08	8.11	0.63	5.08	8.11	0.63	5.08	8.11	0.63
	12	11.40	7.62	1.50	8.28	8.41	0.99	6.31	8.85	0.71	5.42	9.01	0.60	5.42	9.01	0.60	5.42	9.01	0.60
	15	11.17	8.07	1.38	8.23	8.83	0.93	6.12	9.38	0.65	5.50	9.46	0.58	5.50	9.46	0.58	5.50	9.46	0.58
	20	10.82	8.80	1.23	8.10	9.64	0.84	6.18	10.02	0.62	5.17	10.24	0.50	5.17	10.24	0.50	5.17	10.24	0.50
	25	10.65	9.75	1.09	8.14	10.30	0.79	6.16	10.68	0.58	5.70	10.83	0.53	5.70	10.83	0.53	5.70	10.83	0.53
30	/	/	/	/	/	/	/	/	/	/	/	/	/	/	/	/	/	/	/
35	/	/	/	/	/	/	/	/	/	/	/	/	/	/	/	/	/	/	/
30	-25	5.00	2.04	2.45	5.00	2.04	2.45	3.75	2.33	1.61	2.52	2.58	0.98	2.14	2.64	0.81	2.14	2.64	0.81
	-20	5.95	2.34	2.54	5.95	2.34	2.54	4.55	2.63	1.73	3.03	2.89	1.05	2.56	3.01	0.85	2.56	3.01	0.85
	-15	7.36	2.56	2.87	7.18	2.58	2.78	5.15	2.92	1.76	3.43	3.20	1.07	3.00	3.30	0.91	3.00	3.30	0.91
	-10	8.53	2.88	2.96	7.08	3.11	2.28	5.39	3.43	1.57	3.26	3.80	0.86	3.26	3.80	0.86	3.26	3.80	0.86
	-7	8.78	3.10	2.84	6.93	3.43	2.02	5.31	3.70	1.44	3.70	4.04	0.92	3.70	4.04	0.92	3.70	4.04	0.92
	-5	8.99	3.30	2.72	6.97	3.70	1.89	5.32	3.99	1.33	3.98	4.35	0.92	3.98	4.35	0.92	3.98	4.35	0.92
	-2	9.26	3.54	2.62	7.10	4.10	1.73	5.35	4.42	1.21	3.56	4.70	0.76	3.56	4.70	0.76	3.56	4.70	0.76
	0	9.18	3.74	2.46	7.10	4.26	1.67	5.31	4.59	1.16	3.73	4.92	0.76	3.73	4.92	0.76	3.73	4.92	0.76
	2	9.30	4.00	2.32	7.10	4.49	1.58	5.35	4.86	1.10	3.94	5.18	0.76	3.94	5.18	0.76	3.94	5.18	0.76
	5	10.03	4.58	2.19	7.70	5.02	1.53	5.82	5.41	1.08	4.13	5.87	0.70	4.13	5.87	0.70	4.13	5.87	0.70
	7	10.60	5.01	2.11	8.34	5.42	1.54	6.31	5.88	1.07	4.52	6.12	0.74	4.52	6.12	0.74	4.52	6.12	0.74
	10	11.02	5.64	1.95	8.41	6.21	1.35	6.30	6.60	0.96	4.98	6.79	0.73	4.98	6.79	0.73	4.98	6.79	0.73
	12	11.27	5.97	1.89	8.32	6.50	1.28	6.24	6.82	0.92	5.32	7.12	0.75	5.32	7.12	0.75	5.32	7.12	0.75
	15	11.03	6.47	1.70	8.28	7.06	1.17	6.22	7.41	0.84	5.41	7.59	0.71	5.41	7.59	0.71	5.41	7.59	0.71
	20	10.71	7.48	1.43	8.24	7.89	1.04	6.13	8.25	0.74	5.06	8.30	0.61	5.06	8.30	0.61	5.06	8.30	0.61
	25	10.51	8.70	1.21	8.05	9.06	0.89	6.10	9.77	0.62	5.61	9.75	0.58	5.61	9.75	0.58	5.61	9.75	0.58
30	10.50	9.80	1.07	8.21	10.35	0.79	6.21	10.78	0.58	6.16	11.02	0.56	6.16	11.02	0.56	6.16	11.02	0.56	
35	/	/	/	/	/	/	/	/	/	/	/	/	/	/	/	/	/	/	/
35	-25	4.71	1.98	2.38	4.71	1.98	2.38	3.67	2.05	1.79	2.41	2.25	1.07	2.09	2.35	0.89	2.09	2.35	0.89
	-20	5.91	2.22	2.67	5.91	2.22	2.67	4.46	2.34	1.90	2.93	2.62	1.12	2.50	2.64	0.95	2.50	2.64	0.95
	-15	7.25	2.40	3.02	7.25	2.40	3.02	5.40	2.56	2.11	3.60	2.87	1.25	2.91	2.96	0.98	2.91	2.96	0.98
	-10	8.02	2.75	2.91	7.22	2.86	2.53	5.44	3.04	1.79	3.16	3.28	0.96	3.16	3.28	0.96	3.16	3.28	0.96
	-7	8.32	2.85	2.92	7.00	3.00	2.33	5.35	3.43	1.56	3.60	3.52	1.02	3.60	3.52	1.02	3.60	3.52	1.02
	-5	8.57	3.11	2.76	7.03	3.36	2.09	5.25	3.62	1.45	3.88	3.72	1.04	3.88	3.72	1.04	3.88	3.72	1.04
	-2	8.88	3.37	2.64	7.10	3.70	1.92	5.40	3.97	1.36	3.47	4.16	0.84	3.47	4.16	0.84	3.47	4.16	0.84
	0	8.77	3.45	2.54	7.12	3.80	1.87	5.36	4.08	1.31	3.66	4.37	0.84	3.66	4.37	0.84	3.66	4.37	0.84
	2	8.90	3.60	2.47	7.10	3.85	1.84	5.38	4.32	1.25	3.84	4.48	0.86	3.84	4.48	0.86	3.84	4.48	0.86
	5	9.63	4.17	2.31	7.72	4.55	1.70	5.90	4.85	1.22	4.01	5.16	0.78	4.01	5.16	0.78	4.01	5.16	0.78
	7	10.17	4.59	2.22	8.40	5.00	1.68	6.37	5.39	1.18	4.40	5.64	0.78	4.40	5.64	0.78	4.40	5.64	0.78
	10	10.63	5.10	2.09	8.45	5.60	1.51	6.36	5.94	1.07	4.86	6.43	0.76	4.86	6.43	0.76	4.86	6.43	0.76
	12	10.92	5.50	1.99	8.34	6.14	1.36	6.31	6.51	0.97	5.19	6.61	0.79	5.19	6.61	0.79	5.19	6.61	0.79
	15	10.69	5.83	1.83	8.31	6.35	1.31	6.30	6.70	0.94	5.31	6.90	0.77	5.31	6.90	0.77	5.31	6.90	0.77
	20	10.41	6.58	1.58	8.26	7.01	1.18	6.23	7.36	0.85	4.92	7.57	0.65	4.92	7.57	0.65	4.92	7.57	0.65
	25	10.25	7.65	1.34	8.12	8.17	0.99	6.22	8.48	0.73	5.46	8.64	0.63	5.46	8.64	0.63	5.46	8.64	0.63
30	10.43	8.94	1.17	8.10	9.55	0.85	6.10	9.94	0.61	6.00	10.06	0.60	6.00	10.06	0.60	6.00	10.06	0.60	
35	10.30	10.10	1.02	8.19	10.58	0.77	6.60	11.13	0.59	6.60	11.13	0.59	6.60	11.13	0.59	6.60	11.13	0.59	
40	-25	4.72	1.67	2.82	4.31	1.70	2.54	3.23	1.83	1.77	2.14	2.19	0.98	2.14	2.19	0.98	2.14	2.19	0.98
	-20	6.33	2.12	2.98	5.82	2.14	2.71	4.37	2.26	1.93	2.52	2.47	1.02	2.52	2.47	1.02	2.52	2.47	1.02
	-15	7.22	2.25	3.21	7.22	2.25	3.21	5.44	2.35	2.31	2.98	2.86	1.04	2.98	2.86	1.04	2.98	2.86	1.04
	-10	7.92	2.59	3.06	7.18	2.67	2.69	5.54	2.79	1.98	3.21	3.10	1.03	3.21	3.10	1.03	3.21	3.10	1.03
	-7	8.22	2.78	2.96	7.03	2.93	2.40	5.24	3.12	1.68	3.65	3.40	1.07	3.65	3.40	1.07	3.65	3.40	1.07
	-5	8.46	2.92	2.90	7.00	3.12	2.24	5.27	3.28	1.61	3.95	3.57	1.10	3.95	3.57	1.10	3.95	3.57	1.10
	-2	8.77	3.15	2.78	7.01	3.40	2.06	5.42	3.57	1.52	3.98	3.79	1.05	3.98	3.79	1.05	3.98	3.79	1.05
	0	8.62	3.20	2.69	6.97	3.47	2.01	5.41	3.63	1.49	4.10	3.84	1.07	4.10	3.84	1.07	4.10	3.84	1.07
	2	8.74	3.38	2.59	6.98	3.67	1.90	5.38	3.86	1.39	4.37	4.07	1.07	4.37	4.07	1.07	4.37	4.07	1.07
	5	9.47	3.81	2.49	7.85	4.07	1.93	6.02	4.30	1.40	4.87	4.54	1.07	4.87	4.54	1.07	4.87	4.54	1.07
	7	9.98	4.15	2.40	8.39	4.42	1.90	6.37	4.69	1.36	5.33	4.83	1.10	5.33	4.83	1.10	5.33	4.83	1.10
	10	10.42	4.60	2.27	8.31	4.97	1.67	6.38	5.29	1.21	5.64	5.47	1.03	5.64	5.47	1.03	5.64	5.47	1.03
	12	10.68	4.94	2.16	8.37	5.41	1.55	6.36	5.72	1.11	5.98	5.83	1.03	5.98	5.83	1.03	5.98	5.83	1.03
	15	10.48	5.22	2.01	8.15	5.64	1.45	6.29	5.98	1.05	6.08	6.08	1.00	6.08	6.08	1.00	6.08	6.08	1.00
	20	10.19	5.84	1.75	8.28	6.21	1.33	6.28	6.53	0.96	5.54	6.62	0.84	5.54	6.62	0.84	5.54	6.62	0.84
	25	9.99	6.69	1.49	8.14	7.13	1.14	6.26	7.47	0.84	6.13	7.49	0.						

R290 M thermal Arctic HT Series



LWT	DB	Maximum			100%(Nonimal)			75%			50%			25%			Minimum		
		HC	COP	PI	HC	COP	PI	HC	COP	PI	HC	COP	PI	HC	COP	PI	HC	COP	PI
45	-25	4.58	1.63	2.80	4.58	1.63	2.80	3.44	1.80	1.91	2.38	1.85	1.29	2.38	1.85	1.29	2.38	1.85	1.29
	-20	6.24	1.91	3.27	5.74	1.94	2.96	4.31	1.96	2.20	2.65	2.20	1.20	2.65	2.20	1.20	2.65	2.20	1.20
	-15	7.18	2.13	3.37	6.54	2.14	3.05	4.90	2.18	2.25	2.88	2.50	1.15	2.88	2.50	1.15	2.88	2.50	1.15
	-10	7.79	2.21	3.52	7.10	2.28	3.11	5.32	2.58	2.06	3.59	2.68	1.34	3.59	2.68	1.34	3.59	2.68	1.34
	-7	8.12	2.23	3.64	7.10	2.30	3.09	5.35	2.86	1.87	4.09	2.93	1.40	4.09	2.93	1.40	4.09	2.93	1.40
	-5	8.37	2.54	3.30	7.16	2.76	2.59	5.60	3.03	1.85	4.38	3.10	1.41	4.38	3.10	1.41	4.38	3.10	1.41
	-2	8.70	2.71	3.21	7.20	2.98	2.42	5.64	3.27	1.72	4.25	3.30	1.29	4.25	3.30	1.29	4.25	3.30	1.29
	0	8.49	2.75	3.08	7.29	2.99	2.44	5.62	3.31	1.70	4.34	3.33	1.30	4.34	3.33	1.30	4.34	3.33	1.30
	2	8.61	2.92	2.95	7.70	3.00	2.57	5.76	3.48	1.66	4.62	3.51	1.31	4.62	3.51	1.31	4.62	3.51	1.31
	5	9.11	3.41	2.67	7.99	3.56	2.24	6.13	3.73	1.65	5.04	3.82	1.32	5.04	3.82	1.32	5.04	3.82	1.32
	7	9.57	3.71	2.58	8.20	3.85	2.13	6.15	4.13	1.49	5.52	4.25	1.30	5.52	4.25	1.30	5.52	4.25	1.30
	10	10.02	4.09	2.45	8.27	4.32	1.91	6.25	4.55	1.37	5.87	4.60	1.28	5.87	4.60	1.28	5.87	4.60	1.28
	12	10.26	4.37	2.35	8.36	4.67	1.79	6.48	4.90	1.32	6.28	4.92	1.28	6.28	4.92	1.28	6.28	4.92	1.28
	15	10.06	4.61	2.18	8.15	4.87	1.68	6.35	5.08	1.25	6.35	5.08	1.25	6.35	5.08	1.25	6.35	5.08	1.25
	20	9.76	5.10	1.91	8.10	5.34	1.52	6.19	5.62	1.10	5.93	5.66	1.05	5.93	5.66	1.05	5.93	5.66	1.05
	25	9.58	5.78	1.66	8.15	6.06	1.35	6.56	6.33	1.04	6.56	6.33	1.04	6.56	6.33	1.04	6.56	6.33	1.04
30	9.75	6.58	1.48	8.00	6.84	1.17	7.24	7.11	1.02	7.24	7.11	1.02	7.24	7.11	1.02	7.24	7.11	1.02	
35	9.64	7.59	1.27	8.13	7.86	1.03	7.95	8.01	0.99	7.95	8.01	0.99	7.95	8.01	0.99	7.95	8.01	0.99	
50	-25	4.43	1.46	3.03	4.43	1.46	3.03	3.26	1.72	1.89	2.51	1.86	1.35	2.51	1.86	1.35	2.51	1.86	1.35
	-20	6.15	1.73	3.56	5.46	1.75	3.13	4.10	1.94	2.12	3.00	2.09	1.43	3.00	2.09	1.43	3.00	2.09	1.43
	-15	7.07	1.92	3.68	6.26	1.98	3.16	4.69	2.19	2.14	2.95	2.25	1.31	2.95	2.25	1.31	2.95	2.25	1.31
	-10	7.66	2.20	3.49	7.35	2.22	3.31	5.59	2.41	2.32	3.69	2.45	1.51	3.69	2.45	1.51	3.69	2.45	1.51
	-7	7.98	2.23	3.58	7.08	2.28	3.10	5.44	2.56	2.12	4.18	2.72	1.53	4.18	2.72	1.53	4.18	2.72	1.53
	-5	8.24	2.47	3.33	7.13	2.55	2.80	5.45	2.71	2.01	4.48	2.79	1.61	4.48	2.79	1.61	4.48	2.79	1.61
	-2	8.63	2.65	3.25	7.25	2.73	2.65	5.47	2.89	1.89	4.55	2.97	1.53	4.55	2.97	1.53	4.55	2.97	1.53
	0	8.29	2.68	3.09	7.29	2.79	2.62	5.54	2.95	1.88	4.62	3.00	1.54	4.62	3.00	1.54	4.62	3.00	1.54
	2	8.39	2.78	3.02	7.38	2.88	2.56	5.61	3.05	1.84	4.90	3.27	1.50	4.90	3.27	1.50	4.90	3.27	1.50
	5	9.03	3.09	2.92	7.87	3.18	2.47	5.91	3.37	1.75	5.47	3.40	1.61	5.47	3.40	1.61	5.47	3.40	1.61
	7	9.45	3.33	2.83	8.16	3.47	2.35	6.23	3.75	1.66	5.99	3.78	1.58	5.99	3.78	1.58	5.99	3.78	1.58
	10	9.88	3.66	2.70	8.13	3.81	2.13	6.10	3.97	1.53	6.10	3.97	1.53	6.10	3.97	1.53	6.10	3.97	1.53
	12	10.12	3.91	2.59	8.22	4.10	2.00	6.52	4.24	1.54	6.52	4.24	1.54	6.52	4.24	1.54	6.52	4.24	1.54
	15	9.89	4.10	2.41	8.02	4.26	1.88	6.66	4.37	1.53	6.66	4.37	1.53	6.66	4.37	1.53	6.66	4.37	1.53
	20	9.57	4.48	2.13	7.98	4.62	1.73	5.95	4.84	1.23	5.95	4.84	1.23	5.95	4.84	1.23	5.95	4.84	1.23
	25	9.39	5.04	1.86	7.87	5.25	1.50	6.59	5.38	1.22	6.59	5.38	1.22	6.59	5.38	1.22	6.59	5.38	1.22
30	9.56	5.67	1.68	7.88	5.90	1.33	7.27	5.99	1.21	7.27	5.99	1.21	7.27	5.99	1.21	7.27	5.99	1.21	
35	9.40	6.48	1.45	7.98	6.67	1.20	7.98	6.67	1.20	7.98	6.67	1.20	7.98	6.67	1.20	7.98	6.67	1.20	
55	-25	4.34	1.37	3.16	4.34	1.37	3.16	3.25	1.56	2.09	2.59	1.67	1.55	2.59	1.67	1.55	2.59	1.67	1.55
	-20	6.08	1.63	3.72	5.50	1.68	3.29	4.13	1.78	2.32	2.77	2.07	1.34	2.77	2.07	1.34	2.77	2.07	1.34
	-15	6.84	1.78	3.85	6.27	1.80	3.49	4.77	1.92	2.49	3.29	2.12	1.55	3.29	2.12	1.55	3.29	2.12	1.55
	-10	7.56	1.98	3.82	7.23	2.05	3.53	5.46	2.22	2.46	4.08	2.38	1.71	4.08	2.38	1.71	4.08	2.38	1.71
	-7	7.89	2.06	3.83	6.90	2.15	3.21	5.14	2.39	2.15	4.61	2.43	1.90	4.61	2.43	1.90	4.61	2.43	1.90
	-5	8.18	2.16	3.78	7.10	2.27	3.12	5.56	2.52	2.21	4.92	2.60	1.89	4.92	2.60	1.89	4.92	2.60	1.89
	-2	8.56	2.20	3.89	7.32	2.36	3.11	5.70	2.60	2.19	5.00	2.73	1.83	5.00	2.73	1.83	5.00	2.73	1.83
	0	8.17	2.44	3.35	7.32	2.53	2.90	5.73	2.68	2.14	5.03	2.78	1.81	5.03	2.78	1.81	5.03	2.78	1.81
	2	8.25	2.51	3.28	7.80	2.55	3.06	5.74	2.86	2.01	5.33	2.93	1.82	5.33	2.93	1.82	5.33	2.93	1.82
	5	8.87	2.91	3.05	7.87	2.97	2.65	5.96	3.12	1.91	5.96	3.12	1.91	5.96	3.12	1.91	5.96	3.12	1.91
	7	9.27	3.13	2.97	7.80	3.20	2.44	6.52	3.39	1.92	6.52	3.42	1.91	6.52	3.42	1.91	6.52	3.42	1.91
	10	9.69	3.39	2.86	8.00	3.53	2.26	6.11	3.74	1.63	6.11	3.70	1.65	6.11	3.70	1.65	6.11	3.70	1.65
	12	9.88	3.55	2.78	8.05	3.75	2.15	6.55	4.01	1.63	6.55	3.97	1.65	6.55	3.97	1.65	6.55	3.97	1.65
	15	9.67	3.68	2.63	7.85	3.91	2.01	6.71	4.10	1.64	6.71	4.06	1.65	6.71	4.06	1.65	6.71	4.06	1.65
	20	9.31	4.13	2.25	7.78	4.25	1.83	6.04	4.44	1.36	6.04	4.44	1.36	6.04	4.44	1.36	6.04	4.44	1.36
	25	9.14	4.62	1.98	7.83	4.77	1.64	6.66	4.94	1.35	6.66	4.94	1.35	6.66	4.94	1.35	6.66	4.94	1.35
30	9.30	5.19	1.79	7.86	5.36	1.47	7.35	5.47	1.34	7.35	5.47	1.34	7.35	5.47	1.34	7.35	5.47	1.34	
35	9.13	5.55	1.65	8.10	5.78	1.40	8.10	5.84	1.39	8.10	5.84	1.39	8.10	5.84	1.39	8.10	5.84	1.39	
60	-25	/	/	/	/	/	/	/	/	/	/	/	/	/	/	/	/	/	/
	-20	6.00	1.52	3.96	5.48	1.58	3.47	4.11	1.81	2.27	2.92	1.99	1.47	2.92	1.99	1.47	2.92	1.99	1.47
	-15	6.21	1.71	3.63	6.21	1.71	3.63	4.65	1.93	2.42	3.45	2.04	1.69	3.45	2.04	1.69	3.45	2.04	1.69
	-10	7.52	1.96	3.84	6.96	1.99	3.49	5.22	2.25	2.32	4.27	2.46	1.73	4.27	2.46	1.73	4.27	2.46	1.73
	-7	7.86	2.01	3.91	6.98	2.08	3.36	5.30	2.35	2.26	4.80	2.50	1.92	4.80	2.50	1.92	4.80	2.50	1.92
	-5	8.13	2.13	3.81	7.17	2.22	3.24	5.45	2.41	2.26	5.14	2.57	2.00	5.14	2.57	2.00	5.14	2.57	2.00
	-2	8.38	2.19	3.83	7.29	2.30	3.17	5.58	2.45	2.28	4.83	2.60	1.86	4.83	2.60	1.86	4.83	2.60	1.86
	0	7.97	2.32	3.44	7.44	2.36	3.15	5.75	2.61	2.20	4.82	2.73	1.77	4.82	2.73	1.77	4.82	2.73	1.77
	2	8.05	2.40	3.36	7.66	2.43	3.15	5.82	2.71	2.15	5.10	2.87	1.78	5.10	2.87	1.78	5.10	2.87	1.78
	5	8.63	2.73	3.16	7.94	2.79	2.85	5.99	3.05	1.96	5.99	3.05	1.96	5.99	3.05	1.96	5.99	3.05	1.96
	7	8.99	2.92	3.08	8.31	2.98	2.79	6.24	3.29	1.89	6.24	3.29	1.89	6.24	3.29	1.89	6.24	3.29	1.89
	10	9.37	3.13	3.00	8.04	3.30	2.43	6.10	3.61	1.69	6.10	3.61	1.69	6.10	3.61	1.69	6.10	3.61	1.69
	12	9.59	3.37	2.85	8.07	3.56	2.27	6.51	3.82	1.70	6.51	3.82	1.70	6.51	3.82	1.70	6.51	3.82	1.70
	15	9.36	3.51	2.67	7.89	3.65	2.16	6.68	3.98	1.68	6.68	3.98	1.68	6.68	3.98	1.68	6.68	3.98	1.68
	20	9.01	3.79	2.37	8.01	3.97	2.02	5.99	4.36	1.37	5.99	4.36	1.37	5.99	4.36	1.37	5.99	4.36	1.37
	25	8.79	4.21	2.09	7.90	4.38	1.80	6.35											

LWT	DB	Maximum			100%(Nonimal)			75%			50%			25%			Minimum		
		HC	COP	PI	HC	COP	PI	HC	COP	PI	HC	COP	PI	HC	COP	PI	HC	COP	PI
65	-25	/	/	/	/	/	/	/	/	/	/	/	/	/	/	/	/	/	/
	-20	5.43	1.48	3.67	5.43	1.48	3.67	4.07	1.53	2.66	2.82	1.62	1.74	2.82	1.62	1.74	2.82	1.62	1.74
	-15	6.15	1.60	3.84	6.15	1.60	3.84	4.62	1.66	2.78	3.45	1.87	1.84	3.45	1.87	1.84	3.45	1.87	1.84
	-10	7.49	1.83	4.08	6.96	1.87	3.73	5.22	1.89	2.76	4.10	2.12	1.93	4.10	2.12	1.93	4.10	2.12	1.93
	-7	7.80	1.96	3.97	7.21	2.02	3.57	5.47	2.11	2.59	4.63	2.17	2.13	4.63	2.17	2.13	4.63	2.17	2.13
	-5	8.09	2.02	4.00	7.21	2.06	3.50	5.40	2.16	2.50	4.98	2.29	2.18	4.98	2.29	2.18	4.98	2.29	2.18
	-2	8.27	2.08	3.97	7.33	2.12	3.46	5.63	2.20	2.56	4.64	2.41	1.93	4.64	2.41	1.93	4.64	2.41	1.93
	0	7.80	2.19	3.56	7.45	2.19	3.40	5.68	2.23	2.55	4.58	2.51	1.82	4.58	2.51	1.82	4.58	2.51	1.82
	2	7.84	2.26	3.47	7.48	2.27	3.30	5.75	2.35	2.45	4.86	2.48	1.96	4.86	2.48	1.96	4.86	2.48	1.96
	5	8.37	2.41	3.47	8.02	2.44	3.28	6.05	2.56	2.36	5.44	2.71	2.01	5.44	2.71	2.01	5.44	2.71	2.01
	7	8.71	2.57	3.39	8.11	2.67	3.03	6.17	2.79	2.21	5.95	2.89	2.06	5.95	2.89	2.06	5.95	2.89	2.06
	10	9.05	2.78	3.26	8.06	2.90	2.78	6.11	3.02	2.02	5.75	3.14	1.83	5.75	3.14	1.83	5.75	3.14	1.83
	12	9.28	2.94	3.16	8.07	3.08	2.62	6.16	3.23	1.91	6.16	3.20	1.92	6.16	3.20	1.92	6.16	3.20	1.92
	15	9.02	3.04	2.97	7.87	3.17	2.48	6.31	3.30	1.91	6.31	3.30	1.91	6.31	3.30	1.91	6.31	3.30	1.91
	20	8.61	3.29	2.62	7.96	3.35	2.38	5.99	3.55	1.69	5.39	3.67	1.47	5.39	3.67	1.47	5.39	3.67	1.47
25	8.38	3.66	2.29	8.03	3.72	2.16	5.99	3.96	1.51	5.99	3.96	1.51	5.99	3.96	1.51	5.99	3.96	1.51	
30	8.40	3.95	2.13	7.86	3.99	1.97	6.61	4.01	1.65	6.61	4.01	1.65	6.61	4.01	1.65	6.61	4.01	1.65	
35	/	/	/	/	/	/	/	/	/	/	/	/	/	/	/	/	/	/	/
70	-25	/	/	/	/	/	/	/	/	/	/	/	/	/	/	/	/	/	/
	-20	/	/	/	/	/	/	/	/	/	/	/	/	/	/	/	/	/	/
	-15	6.16	1.53	4.03	6.16	1.53	4.03	4.62	1.66	2.78	3.19	1.93	1.66	3.19	1.93	1.66	3.19	1.93	1.66
	-10	7.46	1.76	4.24	6.96	1.80	3.87	5.28	1.92	2.75	3.99	2.12	1.88	3.99	2.12	1.88	3.99	2.12	1.88
	-7	7.79	1.86	4.20	6.98	1.87	3.73	5.36	1.99	2.69	4.55	2.13	2.13	4.55	2.13	2.13	4.55	2.13	2.13
	-5	8.04	1.94	4.14	7.10	1.98	3.58	5.46	2.10	2.59	4.87	2.25	2.17	4.87	2.25	2.17	4.87	2.25	2.17
	-2	8.25	1.98	4.16	7.39	1.99	3.71	5.61	2.13	2.63	4.46	2.32	1.92	4.46	2.32	1.92	4.46	2.32	1.92
	0	7.71	2.04	3.78	7.46	2.05	3.63	5.69	2.19	2.60	4.50	2.38	1.89	4.50	2.38	1.89	4.50	2.38	1.89
	2	7.72	2.09	3.69	7.53	2.10	3.58	5.76	2.27	2.53	4.59	2.42	1.89	4.59	2.42	1.89	4.59	2.42	1.89
	5	8.21	2.26	3.62	8.00	2.28	3.50	6.04	2.46	2.45	5.14	2.58	1.99	5.14	2.58	1.99	5.14	2.58	1.99
	7	8.48	2.41	3.53	8.12	2.48	3.28	6.12	2.72	2.25	5.62	2.82	2.00	5.62	2.82	2.00	5.62	2.82	2.00
	10	8.87	2.55	3.48	8.11	2.65	3.06	6.08	2.90	2.10	5.36	3.02	1.77	5.36	3.02	1.77	5.36	3.02	1.77
	12	9.10	2.65	3.44	8.08	2.81	2.88	6.14	3.08	1.99	5.75	3.11	1.85	5.75	3.11	1.85	5.75	3.11	1.85
	15	8.87	2.79	3.18	8.01	2.87	2.79	5.90	3.14	1.88	5.90	3.14	1.88	5.90	3.14	1.88	5.90	3.14	1.88
	20	8.43	2.96	2.84	8.06	3.06	2.63	6.04	3.30	1.83	5.86	3.34	1.75	5.86	3.34	1.75	5.86	3.34	1.75
25	8.05	3.08	2.61	8.05	3.08	2.61	6.04	3.48	1.74	5.61	3.53	1.59	5.61	3.53	1.59	5.61	3.53	1.59	
30	/	/	/	/	/	/	/	/	/	/	/	/	/	/	/	/	/	/	/
35	/	/	/	/	/	/	/	/	/	/	/	/	/	/	/	/	/	/	/
75	-25	/	/	/	/	/	/	/	/	/	/	/	/	/	/	/	/	/	/
	-20	/	/	/	/	/	/	/	/	/	/	/	/	/	/	/	/	/	/
	-15	/	/	/	/	/	/	/	/	/	/	/	/	/	/	/	/	/	/
	-10	7.34	1.58	4.65	6.76	1.59	4.26	5.07	1.62	3.13	3.92	1.83	2.14	3.92	1.83	2.14	3.92	1.83	2.14
	-7	7.65	1.70	4.51	7.04	1.74	4.05	5.35	1.76	3.04	4.12	1.99	2.07	4.12	1.99	2.07	4.12	1.99	2.07
	-5	7.89	1.76	4.47	7.17	1.80	4.00	5.47	1.82	3.01	4.23	2.04	2.07	4.23	2.04	2.07	4.23	2.04	2.07
	-2	8.06	1.80	4.48	7.42	1.84	4.04	5.65	1.86	3.04	4.31	2.08	2.07	4.31	2.08	2.07	4.31	2.08	2.07
	0	7.47	1.86	4.01	7.47	1.86	4.01	5.74	1.88	3.06	4.40	2.11	2.09	4.40	2.11	2.09	4.40	2.11	2.09
	2	7.54	1.93	3.91	7.54	1.93	3.91	5.69	1.96	2.91	4.51	2.16	2.08	4.51	2.16	2.08	4.51	2.16	2.08
	5	7.79	2.06	3.78	7.79	2.06	3.78	5.73	2.18	2.63	4.80	2.42	1.99	4.80	2.42	1.99	4.80	2.42	1.99
	7	8.04	2.15	3.73	8.04	2.15	3.73	6.09	2.36	2.58	5.26	2.57	2.05	5.26	2.57	2.05	5.26	2.57	2.05
	10	8.12	2.51	3.24	8.12	2.51	3.24	6.24	2.60	2.40	4.87	2.66	1.83	4.87	2.66	1.83	4.87	2.66	1.83
	12	8.10	2.61	3.11	8.10	2.61	3.11	6.27	2.72	2.31	5.22	2.78	1.88	5.22	2.78	1.88	5.22	2.78	1.88
	15	8.14	2.66	3.06	8.14	2.66	3.06	6.23	2.78	2.24	5.37	2.84	1.89	5.37	2.84	1.89	5.37	2.84	1.89
	20	8.02	2.77	2.90	8.02	2.77	2.90	6.20	2.82	2.20	4.59	3.08	1.49	4.59	3.08	1.49	4.59	3.08	1.49
25	/	/	/	/	/	/	/	/	/	/	/	/	/	/	/	/	/	/	/
30	/	/	/	/	/	/	/	/	/	/	/	/	/	/	/	/	/	/	/
35	/	/	/	/	/	/	/	/	/	/	/	/	/	/	/	/	/	/	/

Abbreviations:

- LWT: Leaving water temperature (°C)
- DB: Dry-bulb temperature for Outdoor air temperature (°C)
- HC: Total heating capacity (kW)
- PI: Power input (kW)

R290 M thermal Arctic HT Series



10kW Heating Capacity

LWT	DB	Maximum			100%(Nonimal)			75%			50%			25%			Minimum		
		HC	COP	PI	HC	COP	PI	HC	COP	PI	HC	COP	PI	HC	COP	PI	HC	COP	PI
25	-25	5.55	2.14	2.59	5.55	2.14	2.59	4.16	2.48	1.83	2.75	2.77	1.17	2.19	2.85	0.77	2.19	2.85	0.77
	-20	6.71	2.34	2.87	6.71	2.34	2.87	5.03	2.67	1.88	3.34	3.00	1.23	2.61	3.10	0.84	2.61	3.10	0.84
	-15	7.66	2.70	2.83	7.66	2.70	2.83	5.74	3.01	1.93	3.83	3.45	1.24	3.05	3.56	0.85	3.05	3.56	0.85
	-10	8.76	3.05	2.87	8.05	3.34	2.41	6.06	3.74	1.60	4.04	4.17	1.03	3.36	4.25	0.79	3.36	4.25	0.79
	-7	9.12	3.26	2.80	8.03	3.60	2.23	6.11	3.95	1.56	4.12	4.40	0.97	3.80	4.42	0.86	3.80	4.42	0.86
	-5	9.34	3.45	2.71	8.03	3.81	2.11	6.09	4.22	1.44	4.12	4.61	0.89	4.07	4.62	0.88	4.07	4.62	0.88
	-2	9.70	3.90	2.49	8.09	4.28	1.89	6.11	4.71	1.30	4.10	5.20	0.79	3.64	5.25	0.69	3.64	5.25	0.69
	0	9.68	4.08	2.37	8.20	4.44	1.84	6.15	4.85	1.27	4.13	5.28	0.78	3.82	5.31	0.72	3.82	5.31	0.72
	2	9.84	4.37	2.25	8.21	4.78	1.72	6.21	5.22	1.19	4.17	5.70	0.73	4.03	5.71	0.71	4.03	5.71	0.71
	5	10.73	5.28	2.03	8.80	5.69	1.55	6.65	6.13	1.08	4.50	6.51	0.69	4.23	6.52	0.65	4.23	6.52	0.65
	7	11.46	5.70	2.01	9.97	6.26	1.59	7.48	6.70	1.12	5.07	7.06	0.72	4.62	7.15	0.65	4.62	7.15	0.65
	10	11.86	6.65	1.78	9.67	7.22	1.34	7.41	7.66	0.97	5.08	8.11	0.63	5.08	8.11	0.63	5.08	8.11	0.63
	12	12.16	7.55	1.61	9.70	8.21	1.18	7.44	8.59	0.87	5.42	9.01	0.60	5.42	9.01	0.60	5.42	9.01	0.60
	15	11.93	7.92	1.51	9.54	8.55	1.12	7.15	9.11	0.78	5.50	9.46	0.58	5.50	9.46	0.58	5.50	9.46	0.58
	20	11.73	8.77	1.34	9.62	9.33	1.03	7.21	9.75	0.74	5.17	10.24	0.50	5.17	10.24	0.50	5.17	10.24	0.50
	25	11.87	9.45	1.26	9.67	9.98	0.97	7.19	10.51	0.68	5.70	10.83	0.48	5.70	10.83	0.53	5.70	10.83	0.53
30	/	/	/	/	/	/	/	/	/	/	/	/	/	/	/	/	/	/	/
35	/	/	/	/	/	/	/	/	/	/	/	/	/	/	/	/	/	/	/
30	-25	5.46	2.01	2.71	5.46	2.01	2.71	4.09	2.30	1.78	2.69	2.58	1.04	2.14	2.64	0.81	2.14	2.64	0.81
	-20	6.62	2.31	2.86	6.62	2.31	2.86	4.97	2.59	1.92	3.26	2.87	1.13	2.56	3.01	0.85	2.56	3.01	0.85
	-15	7.57	2.54	2.98	7.57	2.54	2.98	5.67	2.85	1.99	3.78	3.18	1.19	3.00	3.30	0.91	3.00	3.30	0.91
	-10	8.65	2.86	3.03	8.05	2.94	2.73	6.06	3.28	1.85	4.04	3.65	1.11	3.26	3.80	0.86	3.26	3.80	0.86
	-7	9.00	3.06	2.94	8.03	3.20	2.51	6.11	3.60	1.70	4.12	3.93	1.05	3.70	4.04	0.92	3.70	4.04	0.92
	-5	9.24	3.23	2.86	8.03	3.45	2.33	6.09	3.84	1.59	4.12	4.20	0.98	3.98	4.35	0.92	3.98	4.35	0.92
	-2	9.60	3.48	2.76	8.04	3.86	2.08	6.14	4.22	1.45	4.16	4.57	0.91	3.56	4.70	0.76	3.56	4.70	0.76
	0	9.56	3.68	2.60	8.20	4.00	2.05	6.20	4.34	1.43	4.20	4.73	0.89	3.73	4.92	0.76	3.73	4.92	0.76
	2	9.70	3.91	2.48	8.21	4.27	1.92	6.26	4.63	1.35	4.25	5.02	0.85	3.94	5.18	0.76	3.94	5.18	0.76
	5	10.56	4.49	2.35	8.77	4.82	1.82	6.62	5.27	1.25	4.53	5.69	0.80	4.13	5.87	0.70	4.13	5.87	0.70
	7	11.24	4.82	2.33	9.92	5.16	1.92	7.46	5.68	1.31	4.96	5.97	0.83	4.52	6.12	0.74	4.52	6.12	0.74
	10	11.65	5.50	2.12	9.66	5.94	1.63	7.38	6.36	1.16	4.98	6.79	0.73	4.98	6.79	0.73	4.98	6.79	0.73
	12	11.95	5.85	2.04	9.71	6.28	1.55	7.45	6.55	1.14	5.32	7.12	0.75	5.32	7.12	0.75	5.32	7.12	0.75
	15	11.73	6.35	1.85	9.53	6.78	1.41	7.17	7.22	0.99	5.41	7.59	0.71	5.41	7.59	0.71	5.41	7.59	0.71
	20	11.56	7.33	1.58	9.62	7.77	1.24	7.24	8.01	0.90	5.06	8.30	0.61	5.06	8.30	0.61	5.06	8.30	0.61
	25	11.71	8.45	1.39	9.68	8.80	1.10	7.25	9.50	0.76	5.61	9.75	0.58	5.61	9.75	0.58	5.61	9.75	0.58
30	11.47	9.49	1.21	9.57	10.06	0.95	7.35	10.48	0.70	6.16	11.02	0.56	6.16	11.02	0.56	6.16	11.02	0.56	
35	/	/	/	/	/	/	/	/	/	/	/	/	/	/	/	/	/	/	/
35	-25	5.37	1.92	2.80	5.37	1.92	2.80	3.96	2.01	1.97	2.62	2.20	1.19	2.09	2.35	0.89	2.09	2.35	0.89
	-20	6.54	2.19	2.99	6.54	2.19	2.99	4.83	2.27	2.13	3.22	2.57	1.25	2.50	2.64	0.95	2.50	2.64	0.95
	-15	7.45	2.39	3.12	7.45	2.39	3.12	5.78	2.50	2.31	3.88	2.72	1.43	2.91	2.96	0.98	2.91	2.96	0.98
	-10	8.54	2.69	3.18	7.60	2.82	2.70	5.74	3.01	1.91	3.92	3.12	1.26	3.16	3.28	0.96	3.16	3.28	0.96
	-7	8.89	2.78	3.20	8.00	2.85	2.81	6.00	3.22	1.86	4.00	3.45	1.16	3.60	3.52	1.02	3.60	3.52	1.02
	-5	9.12	3.04	3.00	8.00	3.22	2.49	6.32	3.49	1.81	4.24	3.71	1.14	3.88	3.72	1.04	3.88	3.72	1.04
	-2	9.49	3.29	2.88	8.02	3.55	2.26	6.40	3.83	1.67	4.26	4.05	1.05	3.47	4.16	0.84	3.47	4.16	0.84
	0	9.42	3.37	2.80	8.06	3.65	2.21	6.55	3.90	1.68	4.36	4.18	1.04	3.66	4.37	0.84	3.66	4.37	0.84
	2	9.57	3.55	2.69	8.20	3.65	2.25	6.10	4.03	1.52	4.18	4.44	0.94	3.84	4.48	0.86	3.84	4.48	0.86
	5	10.40	4.00	2.60	8.81	4.35	2.02	6.59	4.70	1.40	4.53	5.12	0.88	4.01	5.16	0.78	4.01	5.16	0.78
	7	11.05	4.40	2.51	10.00	4.70	2.13	7.50	5.12	1.47	4.97	5.52	0.90	4.40	5.64	0.78	4.40	5.64	0.78
	10	11.44	4.93	2.32	9.63	5.32	1.81	7.37	5.71	1.29	5.02	6.40	0.78	4.86	6.43	0.76	4.86	6.43	0.76
	12	11.73	5.43	2.16	9.70	5.81	1.67	7.43	6.26	1.19	5.19	6.61	0.79	5.19	6.61	0.79	5.19	6.61	0.79
	15	11.53	5.66	2.04	9.82	6.03	1.63	7.16	6.44	1.11	5.31	6.90	0.77	5.31	6.90	0.77	5.31	6.90	0.77
	20	11.35	6.40	1.78	9.60	6.67	1.44	7.25	7.11	1.02	4.92	7.57	0.65	4.92	7.57	0.65	4.92	7.57	0.65
	25	11.48	7.46	1.54	9.66	7.84	1.23	7.28	8.19	0.89	5.46	8.64	0.63	5.46	8.64	0.63	5.46	8.64	0.63
30	11.25	8.83	1.27	9.66	9.25	1.04	7.21	9.69	0.74	6.00	10.06	0.60	6.00	10.06	0.60	6.00	10.06	0.60	
35	10.81	9.95	1.09	9.67	10.92	0.89	7.41	10.95	0.68	6.60	11.13	0.59	6.60	11.13	0.59	6.60	11.13	0.59	
40	-25	5.29	1.64	3.23	5.29	1.64	3.23	3.88	1.72	2.25	2.56	2.08	1.23	2.14	2.19	0.98	2.14	2.19	0.98
	-20	6.46	2.10	3.08	6.46	2.10	3.08	4.89	2.21	2.21	3.19	2.40	1.33	2.52	2.47	1.02	2.52	2.47	1.02
	-15	7.35	2.25	3.28	7.35	2.25	3.28	5.65	2.33	2.42	3.77	2.72	1.39	2.98	2.86	1.04	2.98	2.86	1.04
	-10	8.43	2.51	3.35	7.86	2.62	3.00	5.90	2.76	2.14	3.94	2.97	1.32	3.21	3.10	1.03	3.21	3.10	1.03
	-7	8.78	2.70	3.25	7.84	2.85	2.75	5.97	3.05	1.96	4.01	3.35	1.20	3.65	3.40	1.07	3.65	3.40	1.07
	-5	9.10	2.86	3.19	7.89	3.00	2.63	5.92	3.26	1.82	4.01	3.54	1.13	3.95	3.57	1.10	3.95	3.57	1.10
	-2	9.39	3.09	3.04	7.98	3.27	2.44	6.05	3.53	1.71	3.98	3.79	1.05	3.98	3.79	1.05	3.98	3.79	1.05
	0	9.29	3.15	2.95	8.05	3.31	2.43	6.09	3.59	1.69	4.10	3.84	1.07	4.10	3.84	1.07	4.10	3.84	1.07
	2	9.43	3.31	2.85	8.20	3.50	2.34	6.15	3.79	1.62	4.37	4.07	1.07	4.37	4.07	1.07	4.37	4.07	1.07
	5	10.25	3.69	2.78	8.74	3.94	2.22	6.67	4.24	1.57	4.87	4.54	1.07	4.87	4.54	1.07	4.87	4.54	1.07
	7	10.86	4.03	2.69	9.98	4.15	2.40	7.50	4.57	1.64	5.33	4.83	1.10	5.33	4.83	1.10	5.33	4.83	1.10
	10	11.23	4.47	2.51	9.69	4.74	2.05	7.34	5.14	1.43	5.64	5.47	1.03	5.64	5.47	1.03	5.64	5.47	1.03
	12	11.51	4.80	2.40	9.80	5.15	1.90	7.39	5.59	1.32	5.98	5.83	1.03	5.98	5.83	1.03	5.98	5.83	1.03
	15	11.30	5.05	2.24	9.75	5.35	1.82	7.34	5.78	1.27	6.08	6.08	1.00	6.08	6.08	1.00	6.08	6.08	1.00
	20	11.13	5.65	1.97	9.73	5.87	1.66	7.22	6.28	1.15	5.54	6.62	0.84	5.54	6.62	0.84	5.54	6.62	0.84
	25	11.28	6.39	1.76	9.64	6.78	1.42	7.29	7.17	1.02	6.13	7.49	0.82</						

LWT	DB	Maximum			100%(Nonimal)			75%			50%			25%			Minimum		
		HC	COP	PI	HC	COP	PI	HC	COP	PI	HC	COP	PI	HC	COP	PI	HC	COP	PI
45	-25	5.21	1.59	3.27	5.21	1.59	3.27	3.91	1.66	2.36	2.59	1.82	1.42	2.38	1.85	1.29	2.38	1.85	1.29
	-20	6.41	1.89	3.39	6.24	1.91	3.27	4.71	1.95	2.42	3.16	2.16	1.46	2.65	2.20	1.20	2.65	2.20	1.20
	-15	7.24	2.08	3.47	7.24	2.08	3.47	5.52	2.16	2.55	3.72	2.21	1.69	2.88	2.50	1.15	2.88	2.50	1.15
	-10	8.32	2.16	3.86	7.45	2.23	3.34	5.59	2.56	2.18	3.72	2.67	1.39	3.59	2.68	1.34	3.59	2.68	1.34
	-7	8.67	2.21	3.92	7.60	2.25	3.38	5.71	2.63	2.17	4.09	2.93	1.40	4.09	2.93	1.40	4.09	2.93	1.40
	-5	9.08	2.44	3.71	7.64	2.63	2.90	5.81	2.99	1.94	4.38	3.10	1.41	4.38	3.10	1.41	4.38	3.10	1.41
	-2	9.34	2.66	3.50	7.65	2.78	2.75	5.82	3.17	1.83	4.25	3.30	1.29	4.25	3.30	1.29	4.25	3.30	1.29
	0	9.16	2.68	3.42	7.70	2.84	2.71	5.86	3.23	1.81	4.34	3.33	1.30	4.34	3.33	1.30	4.34	3.33	1.30
	2	9.29	2.86	3.25	8.20	2.95	2.78	6.12	3.33	1.84	4.62	3.51	1.31	4.62	3.51	1.31	4.62	3.51	1.31
	5	9.92	3.34	2.97	8.82	3.47	2.54	6.60	3.72	1.77	5.04	3.82	1.32	5.04	3.82	1.32	5.04	3.82	1.32
	7	10.47	3.45	3.04	10.00	3.65	2.74	7.50	4.00	1.87	5.52	4.25	1.30	5.52	4.25	1.30	5.52	4.25	1.30
	10	10.81	3.99	2.71	9.68	4.14	2.34	7.41	4.44	1.67	5.87	4.60	1.28	5.87	4.60	1.28	5.87	4.60	1.28
	12	11.08	4.27	2.59	9.63	4.49	2.15	7.32	4.82	1.52	6.28	4.92	1.28	6.28	4.92	1.28	6.28	4.92	1.28
	15	10.87	4.47	2.43	9.65	4.68	2.06	7.28	4.98	1.46	6.35	5.08	1.25	6.35	5.08	1.25	6.35	5.08	1.25
	20	10.67	4.97	2.15	9.75	5.11	1.91	7.20	5.47	1.32	5.93	5.66	1.05	5.93	5.66	1.05	5.93	5.66	1.05
	25	10.79	5.57	1.94	9.57	5.78	1.65	7.29	6.23	1.17	6.56	6.33	1.04	6.56	6.33	1.04	6.56	6.33	1.04
	30	10.54	6.41	1.64	9.75	6.58	1.48	7.24	7.11	1.02	7.24	7.11	1.02	7.24	7.11	1.02	7.24	7.11	1.02
35	10.09	7.50	1.35	9.63	7.59	1.27	7.95	8.01	0.99	7.95	8.01	0.99	7.95	8.01	0.99	7.95	8.01	0.99	
50	-25	5.09	1.43	3.56	5.09	1.43	3.56	3.74	1.57	2.38	2.51	1.86	1.35	2.51	1.86	1.35	2.51	1.86	1.35
	-20	6.27	1.62	3.87	6.27	1.62	3.87	4.54	1.91	2.38	3.00	2.09	1.43	3.00	2.09	1.43	3.00	2.09	1.43
	-15	7.10	1.91	3.71	6.96	1.95	3.56	5.24	2.12	2.47	3.49	2.16	1.62	2.95	2.25	1.31	2.95	2.25	1.31
	-10	8.18	2.05	3.99	7.57	2.21	3.42	5.68	2.36	2.41	3.79	2.42	1.56	3.69	2.45	1.51	3.69	2.45	1.51
	-7	8.62	2.17	3.98	7.55	2.24	3.37	5.75	2.51	2.29	4.18	2.72	1.53	4.18	2.72	1.53	4.18	2.72	1.53
	-5	9.04	2.35	3.85	7.65	2.51	3.05	5.82	2.66	2.19	4.48	2.79	1.61	4.48	2.79	1.61	4.48	2.79	1.61
	-2	9.29	2.57	3.61	7.86	2.70	2.91	5.94	2.86	2.08	4.55	2.97	1.53	4.55	2.97	1.53	4.55	2.97	1.53
	0	8.99	2.61	3.45	8.03	2.76	2.91	6.12	2.92	2.10	4.62	3.00	1.54	4.62	3.00	1.54	4.62	3.00	1.54
	2	9.11	2.75	3.31	8.26	2.80	2.95	6.24	3.02	2.07	4.90	3.27	1.50	4.90	3.27	1.50	4.90	3.27	1.50
	5	9.85	3.03	3.25	8.63	3.12	2.77	6.57	3.32	1.98	5.47	3.40	1.61	5.47	3.40	1.61	5.47	3.40	1.61
	7	10.36	3.28	3.16	9.75	3.33	2.93	7.39	3.58	2.06	5.99	3.78	1.58	5.99	3.78	1.58	5.99	3.78	1.58
	10	10.48	3.55	2.95	9.45	3.68	2.57	7.09	3.91	1.81	6.10	3.97	1.53	6.10	3.97	1.53	6.10	3.97	1.53
	12	10.75	3.83	2.80	9.42	3.98	2.37	7.14	4.21	1.70	6.52	4.24	1.54	6.52	4.24	1.54	6.52	4.24	1.54
	15	10.51	4.00	2.63	9.41	4.13	2.28	7.14	4.35	1.64	6.66	4.37	1.53	6.66	4.37	1.53	6.66	4.37	1.53
	20	10.31	4.40	2.34	9.53	4.48	2.13	7.12	4.70	1.51	5.95	4.84	1.23	5.95	4.84	1.23	5.95	4.84	1.23
	25	10.41	4.91	2.12	9.38	5.04	1.86	7.13	5.34	1.33	6.59	5.38	1.22	6.59	5.38	1.22	6.59	5.38	1.22
	30	10.11	5.57	1.81	9.36	5.71	1.64	7.27	5.99	1.21	7.27	5.99	1.21	7.27	5.99	1.21	7.27	5.99	1.21
35	9.70	6.45	1.50	9.50	6.47	1.47	7.98	6.67	1.20	7.98	6.67	1.20	7.98	6.67	1.20	7.98	6.67	1.20	
55	-25	5.00	1.36	3.67	5.00	1.36	3.67	3.78	1.53	2.47	2.59	1.67	1.55	2.59	1.67	1.55	2.59	1.67	1.55
	-20	6.21	1.55	3.99	6.21	1.55	3.99	4.66	1.74	2.68	3.10	1.87	1.66	2.77	2.07	1.34	2.77	2.07	1.34
	-15	6.98	1.69	4.13	6.98	1.69	4.13	5.33	1.89	2.82	3.58	1.98	1.81	3.29	2.12	1.55	3.29	2.12	1.55
	-10	8.14	1.89	4.31	7.34	2.02	3.64	5.48	2.20	2.49	4.08	2.38	1.71	4.08	2.38	1.71	4.08	2.38	1.71
	-7	8.61	2.01	4.28	7.40	2.10	3.52	5.54	2.34	2.37	4.61	2.43	1.90	4.61	2.43	1.90	4.61	2.43	1.90
	-5	8.96	2.14	4.20	7.67	2.18	3.52	5.84	2.50	2.33	4.92	2.60	1.89	4.92	2.60	1.89	4.92	2.60	1.89
	-2	9.22	2.19	4.22	8.01	2.23	3.59	6.07	2.58	2.35	5.00	2.73	1.83	5.00	2.73	1.83	5.00	2.73	1.83
	0	8.85	2.40	3.68	8.01	2.46	3.26	6.10	2.67	2.28	5.03	2.78	1.81	5.03	2.78	1.81	5.03	2.78	1.81
	2	8.96	2.46	3.65	8.40	2.50	3.36	6.32	2.81	2.25	5.33	2.93	1.82	5.33	2.93	1.82	5.33	2.93	1.82
	5	9.68	2.86	3.39	8.62	2.92	2.95	6.53	3.12	2.09	5.96	3.12	1.91	5.96	3.12	1.91	5.96	3.12	1.91
	7	10.17	3.00	3.39	9.50	3.05	3.11	7.13	3.33	2.14	6.52	3.42	1.91	6.52	3.42	1.91	6.52	3.42	1.91
	10	10.37	3.15	3.29	9.17	3.35	2.74	7.02	3.60	1.95	6.11	3.70	1.65	6.11	3.70	1.65	6.11	3.70	1.65
	12	10.72	3.30	3.25	9.24	3.50	2.64	6.93	3.95	1.75	6.55	3.97	1.65	6.55	3.97	1.65	6.55	3.97	1.65
	15	10.48	3.53	2.97	9.24	3.79	2.44	6.92	4.04	1.71	6.71	4.06	1.65	6.71	4.06	1.65	6.71	4.06	1.65
	20	10.25	3.85	2.66	9.07	4.10	2.21	6.81	4.37	1.56	6.04	4.44	1.36	6.04	4.44	1.36	6.04	4.44	1.36
	25	10.35	4.20	2.46	9.08	4.60	1.97	6.81	4.92	1.38	6.66	4.94	1.35	6.66	4.94	1.35	6.66	4.94	1.35
	30	10.04	4.87	2.06	9.09	5.16	1.76	7.35	5.47	1.34	7.35	5.47	1.34	7.35	5.47	1.34	7.35	5.47	1.34
35	9.59	5.45	1.76	9.13	5.49	1.66	8.10	5.84	1.39	8.10	5.84	1.39	8.10	5.84	1.39	8.10	5.84	1.39	
60	-25	/	/	/	/	/	/	/	/	/	/	/	/	/	/	/	/	/	/
	-20	6.12	1.50	4.08	5.97	1.57	3.80	4.57	1.77	2.58	3.04	1.97	1.54	2.92	1.99	1.47	2.92	1.99	1.47
	-15	6.94	1.61	4.31	6.94	1.61	4.31	5.33	1.81	2.95	3.57	2.02	1.77	3.45	2.04	1.69	3.45	2.04	1.69
	-10	8.12	1.89	4.30	7.10	1.97	3.61	5.42	2.20	2.46	4.27	2.46	1.73	4.27	2.46	1.73	4.27	2.46	1.73
	-7	8.58	1.95	4.40	7.12	2.03	3.51	5.31	2.35	2.26	4.80	2.50	1.92	4.80	2.50	1.92	4.80	2.50	1.92
	-5	8.90	2.04	4.35	7.46	2.16	3.46	5.68	2.38	2.39	5.14	2.57	2.00	5.14	2.57	2.00	5.14	2.57	2.00
	-2	9.18	2.06	4.44	7.46	2.22	3.36	5.68	2.42	2.35	4.83	2.60	1.86	4.83	2.60	1.86	4.83	2.60	1.86
	0	8.73	2.27	3.85	8.01	2.32	3.45	6.10	2.53	2.42	4.82	2.73	1.77	4.82	2.73	1.77	4.82	2.73	1.77
	2	8.82	2.33	3.78	8.35	2.36	3.54	6.37	2.60	2.45	5.10	2.87	1.78	5.10	2.87	1.78	5.10	2.87	1.78
	5	9.46	2.56	3.69	8.65	2.65	3.27	6.52	2.90	2.24	5.99	3.05	1.96	5.99	3.05	1.96	5.99	3.05	1.96
	7	9.90	2.75	3.60	9.27	2.82	3.28	6.99	3.13	2.23	6.24	3.29	1.89	6.24	3.29	1.89	6.24	3.29	1.89
	10	10.18	2.94	3.46	9.28	3.01	3.08	7.01	3.45	2.03	6.10	3.61	1.69	6.10	3.61	1.69	6.10	3.61	1.69
	12	10.41	3.10	3.36	9.23	3.29	2.81	6.90	3.78	1.83	6.51	3.82	1.70	6.51	3.82	1.70	6.51	3.82	1.70
	15	10.17	3.21	3.16	9.22	3.40	2.71	6.68	3.98	1.68	6.68	3.98	1.68	6.68	3.98	1.68	6.68	3.98	1.68
	20	9.93	3.45	2.87	9.31	3.67	2.54	6.85	4.18	1.64	5.99	4.36	1.37	5.99	4.3				

R290 M thermal Arctic HT Series



LWT	DB	Maximum			100%(Nonimal)			75%			50%			25%			Minimum		
		HC	COP	PI	HC	COP	PI	HC	COP	PI	HC	COP	PI	HC	COP	PI	HC	COP	PI
65	-25	/	/	/	/	/	/	/	/	/	/	/	/	/	/	/	/	/	/
	-20	6.10	1.47	4.16	6.10	1.47	4.16	4.62	1.50	3.08	3.18	1.60	1.99	2.82	1.62	1.74	2.82	1.62	1.74
	-15	6.81	1.57	4.34	6.81	1.57	4.34	5.10	1.63	3.13	3.45	1.87	1.84	3.45	1.87	1.84	3.45	1.87	1.84
	-10	8.01	1.78	4.49	7.40	1.84	4.03	5.60	1.87	2.99	4.10	2.12	1.93	4.10	2.12	1.93	4.10	2.12	1.93
	-7	8.56	1.87	4.58	7.39	1.99	3.71	5.62	2.09	2.69	4.63	2.17	2.13	4.63	2.17	2.13	4.63	2.17	2.13
	-5	8.82	1.94	4.55	7.60	2.05	3.72	5.78	2.12	2.73	4.98	2.29	2.18	4.98	2.29	2.18	4.98	2.29	2.18
	-2	9.14	2.01	4.55	7.87	2.10	3.75	6.00	2.16	2.77	4.64	2.41	1.93	4.64	2.41	1.93	4.64	2.41	1.93
	0	8.58	2.09	4.10	8.15	2.18	3.74	6.21	2.20	2.82	4.58	2.51	1.82	4.58	2.51	1.82	4.58	2.51	1.82
	2	8.64	2.19	3.94	8.28	2.24	3.69	6.32	2.30	2.74	4.86	2.48	1.96	4.86	2.48	1.96	4.86	2.48	1.96
	5	9.21	2.37	3.89	8.66	2.41	3.60	6.53	2.53	2.58	5.44	2.71	2.01	5.44	2.71	2.01	5.44	2.71	2.01
	7	9.61	2.50	3.85	9.26	2.55	3.64	6.98	2.69	2.59	5.95	2.89	2.06	5.95	2.89	2.06	5.95	2.89	2.06
	10	9.84	2.72	3.62	9.20	2.77	3.32	6.98	2.91	2.40	5.75	3.14	1.83	5.75	3.14	1.83	5.75	3.14	1.83
	12	10.05	2.88	3.49	9.28	2.94	3.16	7.00	3.08	2.27	6.16	3.20	1.92	6.16	3.20	1.92	6.16	3.20	1.92
	15	9.81	2.97	3.31	9.30	3.03	3.07	6.84	3.27	2.09	6.31	3.30	1.91	6.31	3.30	1.91	6.31	3.30	1.91
	20	9.56	3.21	2.98	9.30	3.26	2.86	6.91	3.45	2.00	5.39	3.67	1.47	5.39	3.67	1.47	5.39	3.67	1.47
	25	9.60	3.50	2.74	9.22	3.54	2.61	7.00	3.74	1.87	5.99	3.96	1.51	5.99	3.96	1.51	5.99	3.96	1.51
30	9.18	3.90	2.36	9.18	3.90	2.36	6.61	4.01	1.65	6.61	4.01	1.65	6.61	4.01	1.65	6.61	4.01	1.65	
35	/	/	/	/	/	/	/	/	/	/	/	/	/	/	/	/	/	/	/
70	-25	/	/	/	/	/	/	/	/	/	/	/	/	/	/	/	/	/	/
	-20	/	/	/	/	/	/	/	/	/	/	/	/	/	/	/	/	/	/
	-15	6.86	1.45	4.72	6.86	1.45	4.72	5.32	1.61	3.30	3.19	1.93	1.66	3.19	1.93	1.66	3.19	1.93	1.66
	-10	7.86	1.59	4.94	7.11	1.75	4.06	5.43	1.91	2.84	3.99	2.12	1.88	3.99	2.12	1.88	3.99	2.12	1.88
	-7	8.21	1.69	4.85	7.01	1.87	3.76	5.36	1.99	2.69	4.55	2.13	2.13	4.55	2.13	2.13	4.55	2.13	2.13
	-5	8.43	1.78	4.73	7.20	1.96	3.67	5.46	2.10	2.59	4.87	2.25	2.17	4.87	2.25	2.17	4.87	2.25	2.17
	-2	8.78	1.82	4.83	7.39	1.99	3.71	5.61	2.13	2.63	4.46	2.32	1.92	4.46	2.32	1.92	4.46	2.32	1.92
	0	8.37	1.91	4.38	7.58	2.03	3.74	5.69	2.19	2.60	4.50	2.38	1.89	4.50	2.38	1.89	4.50	2.38	1.89
	2	8.40	2.03	4.13	8.40	2.03	4.13	6.38	2.23	2.86	4.59	2.42	1.89	4.59	2.42	1.89	4.59	2.42	1.89
	5	8.90	2.18	4.08	8.90	2.18	4.08	6.53	2.37	2.76	5.14	2.58	1.99	5.14	2.58	1.99	5.14	2.58	1.99
	7	9.23	2.31	4.00	9.23	2.31	4.00	7.03	2.60	2.70	5.62	2.82	2.00	5.62	2.82	2.00	5.62	2.82	2.00
	10	9.43	2.45	3.85	9.43	2.45	3.85	6.94	2.78	2.49	5.36	3.02	1.77	5.36	3.02	1.77	5.36	3.02	1.77
	12	9.66	2.61	3.70	9.66	2.61	3.70	6.93	2.92	2.37	5.75	3.11	1.85	5.75	3.11	1.85	5.75	3.11	1.85
	15	9.40	2.68	3.51	9.40	2.68	3.51	6.89	2.98	2.31	5.90	3.14	1.88	5.90	3.14	1.88	5.90	3.14	1.88
	20	9.21	2.87	3.21	9.21	2.87	3.21	6.92	3.17	2.18	5.86	3.34	1.75	5.86	3.34	1.75	5.86	3.34	1.75
	25	9.18	3.04	3.02	9.18	3.04	3.02	6.94	3.14	2.21	5.61	3.53	1.59	5.61	3.53	1.59	5.61	3.53	1.59
30	/	/	/	/	/	/	/	/	/	/	/	/	/	/	/	/	/	/	/
35	/	/	/	/	/	/	/	/	/	/	/	/	/	/	/	/	/	/	/
75	-25	/	/	/	/	/	/	/	/	/	/	/	/	/	/	/	/	/	/
	-20	/	/	/	/	/	/	/	/	/	/	/	/	/	/	/	/	/	/
	-15	/	/	/	/	/	/	/	/	/	/	/	/	/	/	/	/	/	/
	-10	7.77	1.51	5.16	7.14	1.58	4.51	5.40	1.61	3.36	3.92	1.83	2.14	3.92	1.83	2.14	3.92	1.83	2.14
	-7	8.10	1.62	5.00	7.12	1.73	4.12	5.35	1.76	3.04	4.12	1.99	2.07	4.12	1.99	2.07	4.12	1.99	2.07
	-5	8.31	1.68	4.94	7.26	1.78	4.07	5.47	1.82	3.01	4.23	2.04	2.07	4.23	2.04	2.07	4.23	2.04	2.07
	-2	8.63	1.76	4.89	7.81	1.82	4.28	5.89	1.85	3.18	4.31	2.08	2.07	4.31	2.08	2.07	4.31	2.08	2.07
	0	8.01	1.84	4.36	8.01	1.84	4.36	5.99	1.87	3.21	4.40	2.11	2.09	4.40	2.11	2.09	4.40	2.11	2.09
	2	8.14	1.89	4.30	8.14	1.89	4.30	6.19	1.95	3.18	4.51	2.16	2.08	4.51	2.16	2.08	4.51	2.16	2.08
	5	8.60	1.95	4.42	8.60	1.95	4.42	6.46	2.14	3.02	4.80	2.42	1.99	4.80	2.42	1.99	4.80	2.42	1.99
	7	8.85	2.05	4.32	8.85	2.05	4.32	6.55	2.31	2.84	5.26	2.57	2.05	5.26	2.57	2.05	5.26	2.57	2.05
	10	8.91	2.23	3.99	8.91	2.23	3.99	6.81	2.56	2.66	4.87	2.66	1.83	4.87	2.66	1.83	4.87	2.66	1.83
	12	9.12	2.35	3.88	9.12	2.35	3.88	6.97	2.68	2.60	5.22	2.78	1.88	5.22	2.78	1.88	5.22	2.78	1.88
	15	8.94	2.43	3.68	8.94	2.43	3.68	6.81	2.74	2.49	5.37	2.84	1.89	5.37	2.84	1.89	5.37	2.84	1.89
	20	8.89	2.65	3.36	8.89	2.65	3.36	6.78	2.80	2.42	4.59	3.08	1.49	4.59	3.08	1.49	4.59	3.08	1.49
	25	/	/	/	/	/	/	/	/	/	/	/	/	/	/	/	/	/	/
30	/	/	/	/	/	/	/	/	/	/	/	/	/	/	/	/	/	/	/
35	/	/	/	/	/	/	/	/	/	/	/	/	/	/	/	/	/	/	/

Abbreviations:

LWT: Leaving water temperature (°C)

DB: Dry-bulb temperature for Outdoor air temperature (°C)

HC: Total heating capacity (kW)

PI: Power input (kW)

12kW Heating Capacity

LWT	DB	Maximum			100%(Nonimal)			75%			50%			25%			Minimum		
		HC	COP	PI	HC	COP	PI	HC	COP	PI	HC	COP	PI	HC	COP	PI	HC	COP	PI
25	-25	7.62	2.27	3.36	7.62	2.27	3.36	7.62	2.27	3.36	5.06	2.42	2.09	2.98	2.56	1.17	2.98	2.56	1.17
	-20	9.15	2.60	3.52	9.15	2.60	3.52	7.54	2.74	2.75	5.00	2.95	1.70	3.77	3.11	1.21	3.77	3.11	1.21
	-15	10.59	2.90	3.66	10.06	2.99	3.37	7.52	3.28	2.29	5.02	3.44	1.46	4.37	3.77	1.16	4.37	3.77	1.16
	-10	11.28	3.03	3.72	9.93	3.19	3.11	7.57	3.54	2.14	5.18	3.96	1.31	4.69	3.99	1.18	4.69	3.99	1.18
	-7	11.50	3.26	3.53	9.92	3.61	2.75	7.57	4.11	1.84	5.41	4.44	1.22	5.41	4.44	1.22	5.41	4.44	1.22
	-5	11.55	3.43	3.36	9.62	3.75	2.57	7.28	4.11	1.77	5.60	4.55	1.23	5.60	4.55	1.23	5.60	4.55	1.23
	-2	12.14	3.73	3.25	9.52	4.22	2.26	7.16	4.59	1.56	4.86	5.22	0.93	4.86	5.22	0.93	4.86	5.22	0.93
	0	12.40	3.96	3.13	9.36	4.63	2.02	7.00	5.01	1.40	5.02	5.42	0.93	5.02	5.42	0.93	5.02	5.42	0.93
	2	12.73	4.20	3.03	9.12	5.00	1.83	6.90	5.35	1.29	5.38	5.80	0.93	5.38	5.80	0.93	5.38	5.80	0.93
	5	14.25	4.89	2.91	10.79	5.64	1.91	8.19	6.44	1.27	5.85	7.00	0.84	5.85	7.00	0.84	5.85	7.00	0.84
	7	15.69	5.47	2.87	12.09	6.29	1.92	8.94	6.86	1.30	6.24	7.44	0.84	6.24	7.44	0.84	6.24	7.44	0.84
	10	17.24	6.38	2.70	12.08	7.65	1.58	9.13	8.47	1.08	7.25	8.95	0.81	7.25	8.95	0.81	7.25	8.95	0.81
	12	17.67	7.04	2.51	11.95	8.48	1.41	9.16	9.37	0.98	7.71	9.79	0.79	7.71	9.79	0.79	7.71	9.79	0.79
	15	16.62	7.45	2.23	12.08	8.76	1.38	9.03	9.77	0.92	7.78	10.26	0.76	7.78	10.26	0.76	7.78	10.26	0.76
	20	14.83	8.21	1.81	12.03	9.39	1.28	9.09	10.71	0.85	6.62	11.24	0.59	6.62	11.24	0.59	6.62	11.24	0.59
	25	14.66	9.04	1.62	11.92	10.23	1.17	9.14	11.50	0.79	7.40	11.79	0.63	7.40	11.79	0.63	7.40	11.79	0.63
30	/	/	/	/	/	/	/	/	/	/	/	/	/	/	/	/	/	/	/
35	/	/	/	/	/	/	/	/	/	/	/	/	/	/	/	/	/	/	/
30	-25	7.20	2.03	3.55	7.20	2.03	3.55	7.20	2.03	3.55	4.88	2.12	2.31	2.78	2.25	1.24	2.78	2.25	1.24
	-20	8.71	2.34	3.72	8.71	2.34	3.72	7.53	2.44	3.09	4.99	2.55	1.96	3.56	2.76	1.29	3.56	2.76	1.29
	-15	10.38	2.68	3.87	9.87	2.74	3.60	7.39	2.92	2.53	5.05	3.15	1.61	4.19	3.36	1.25	4.19	3.36	1.25
	-10	10.65	2.72	3.91	9.86	2.82	3.50	7.41	3.10	2.39	4.98	3.44	1.45	4.58	3.58	1.28	4.58	3.58	1.28
	-7	11.30	3.01	3.75	9.92	3.17	3.13	7.62	3.59	2.13	5.39	4.03	1.34	5.39	4.03	1.34	5.39	4.03	1.34
	-5	11.11	3.10	3.59	9.54	3.29	2.90	7.17	3.67	1.95	5.38	4.10	1.31	5.38	4.10	1.31	5.38	4.10	1.31
	-2	11.67	3.35	3.48	9.37	3.70	2.53	7.16	3.98	1.80	4.84	4.30	1.13	4.66	4.56	1.02	4.66	4.56	1.02
	0	11.93	3.56	3.35	9.23	4.05	2.28	6.94	4.31	1.61	4.74	4.63	1.02	4.74	4.63	1.02	4.74	4.63	1.02
	2	12.25	3.76	3.26	9.00	4.35	2.07	6.93	4.55	1.52	5.16	5.02	1.03	5.16	5.02	1.03	5.16	5.02	1.03
	5	13.72	4.36	3.15	10.84	5.13	2.11	8.16	5.45	1.50	5.54	5.92	0.93	5.54	5.92	0.93	5.54	5.92	0.93
	7	15.02	4.86	3.09	12.02	5.43	2.21	9.10	5.80	1.57	5.98	6.33	0.94	5.98	6.33	0.94	5.98	6.33	0.94
	10	16.43	5.61	2.93	11.91	6.48	1.84	9.12	7.03	1.30	6.91	7.52	0.92	6.91	7.52	0.92	6.91	7.52	0.92
	12	16.81	6.12	2.75	11.84	7.12	1.66	8.96	7.79	1.15	7.32	8.10	0.90	7.32	8.10	0.90	7.32	8.10	0.90
	15	15.87	6.43	2.47	11.82	7.45	1.59	9.07	8.44	1.07	7.59	8.73	0.87	7.59	8.73	0.87	7.59	8.73	0.87
	20	14.25	7.18	1.98	12.00	8.01	1.50	8.96	9.19	0.97	6.37	9.36	0.68	6.37	9.36	0.68	6.37	9.36	0.68
	25	14.13	7.83	1.80	11.96	8.50	1.41	9.04	9.58	0.94	7.11	9.62	0.74	7.11	9.62	0.74	7.11	9.62	0.74
30	14.12	9.33	1.51	11.93	9.98	1.20	8.97	11.20	0.80	7.78	11.27	0.69	7.78	11.27	0.69	7.78	11.27	0.69	
35	/	/	/	/	/	/	/	/	/	/	/	/	/	/	/	/	/	/	/
35	-25	7.00	1.88	3.73	7.00	1.88	3.73	7.00	1.88	3.73	4.85	1.92	2.52	2.68	2.02	1.33	2.68	2.02	1.33
	-20	8.53	2.18	3.92	8.53	2.18	3.92	7.53	2.25	3.35	5.07	2.32	2.18	3.47	2.50	1.39	3.47	2.50	1.39
	-15	10.21	2.50	4.08	10.07	2.51	4.01	7.55	2.66	2.83	5.13	2.79	1.84	4.16	2.97	1.40	4.16	2.97	1.40
	-10	10.44	2.52	4.14	9.84	2.59	3.80	7.43	2.81	2.64	5.08	3.20	1.58	4.50	3.28	1.37	4.50	3.28	1.37
	-7	11.10	2.79	3.98	10.00	2.80	3.57	7.56	3.19	2.37	5.25	3.58	1.47	5.25	3.58	1.47	5.25	3.58	1.47
	-5	10.91	2.86	3.81	9.66	2.98	3.24	7.25	3.25	2.23	5.08	3.62	1.40	5.08	3.62	1.40	5.08	3.62	1.40
	-2	11.46	3.09	3.71	9.42	3.34	2.82	7.24	3.58	2.03	4.85	4.14	1.17	4.57	4.12	1.11	4.57	4.12	1.11
	0	11.72	3.28	3.58	9.28	3.61	2.57	7.05	3.85	1.83	4.73	4.33	1.09	4.73	4.33	1.09	4.73	4.33	1.09
	2	12.04	3.45	3.49	9.10	3.80	2.39	7.05	4.04	1.75	5.07	4.50	1.13	5.07	4.50	1.13	5.07	4.50	1.13
	5	13.47	3.99	3.38	10.77	4.59	2.34	8.13	4.83	1.68	5.36	5.18	1.03	5.36	5.18	1.03	5.36	5.18	1.03
	7	14.72	4.42	3.33	12.00	4.80	2.50	9.06	5.11	1.77	5.87	5.61	1.05	5.87	5.61	1.05	5.87	5.61	1.05
	10	15.57	4.92	3.17	12.00	5.45	2.20	9.13	5.80	1.57	6.42	6.22	1.03	6.42	6.22	1.03	6.42	6.22	1.03
	12	15.92	5.33	2.99	12.12	5.91	2.05	9.04	6.35	1.42	6.82	6.71	1.02	6.82	6.71	1.02	6.82	6.71	1.02
	15	15.03	5.61	2.68	12.06	6.34	1.90	8.99	6.90	1.30	7.09	7.20	0.99	7.09	7.20	0.99	7.09	7.20	0.99
	20	13.54	6.47	2.09	11.96	6.95	1.72	9.12	7.72	1.18	5.97	7.99	0.75	5.97	7.99	0.75	5.97	7.99	0.75
	25	13.43	7.08	1.90	11.84	7.50	1.58	9.06	8.23	1.10	6.68	8.47	0.79	6.68	8.47	0.79	6.68	8.47	0.79
30	13.45	8.04	1.67	12.13	8.44	1.44	9.02	8.93	1.01	7.30	9.00	0.81	7.30	9.00	0.81	7.30	9.00	0.81	
35	13.22	9.58	1.38	12.02	9.89	1.22	9.23	10.37	0.89	7.97	10.45	0.76	7.97	10.45	0.76	7.97	10.45	0.76	
40	-25	6.82	1.75	3.90	6.82	1.75	3.90	6.82	1.75	3.90	5.13	1.80	2.84	2.74	1.89	1.45	2.74	1.89	1.45
	-20	8.34	2.03	4.11	8.34	2.03	4.11	7.54	2.08	3.62	5.08	2.18	2.33	3.57	2.31	1.55	3.57	2.31	1.55
	-15	10.03	2.34	4.29	10.03	2.34	4.29	7.59	2.45	3.10	5.20	2.50	2.08	3.99	2.59	1.54	3.99	2.59	1.54
	-10	10.21	2.36	4.33	10.21	2.36	4.33	7.44	2.56	2.91	5.16	2.91	1.77	4.63	2.98	1.55	4.63	2.98	1.55
	-7	10.90	2.59	4.21	10.24	2.68	3.83	7.85	3.01	2.61	5.36	3.39	1.58	5.36	3.39	1.58	5.36	3.39	1.58
	-5	10.70	2.65	4.04	10.09	2.75	3.67	7.65	3.04	2.51	5.43	3.45	1.57	5.43	3.45	1.57	5.43	3.45	1.57
	-2	11.25	2.86	3.94	10.27	2.95	3.48	7.44	3.22	2.31	5.34	3.62	1.47	5.34	3.62	1.47	5.34	3.62	1.47
	0	11.51	3.02	3.81	10.09	3.16	3.19	7.61	3.41	2.23	5.63	3.78	1.49	5.63	3.78	1.49	5.63	3.78	1.49
	2	11.82	3.18	3.72	10.33	3.34	3.09	7.88	3.60	2.19	5.90	3.92	1.51	5.90	3.92	1.51	5.90	3.92	1.51
	5	13.21	3.65	3.62	11.27	4.07	2.77	8.45	4.28	1.97	6.70	4.38	1.53	6.70	4.38	1.53	6.70	4.38	1.53
	7	14.41	4.02	3.58	12.02	4.32	2.78	9.01	4.56	1.98	7.38	4.82	1.53	7.38	4.82	1.53	7.38	4.82	1.53
	10	15.20	4.43	3.43	11.90	4.84	2.46	9.09	5.11	1.78	7.64	5.36	1.43	7.64	5.36	1.43	7.64	5.36	1.43
	12	15.56	4.80	3.24	12.04	5.24	2.30	9.01	5.55	1.62	7.98	5.62	1.42	7.98	5.62	1.42	7.98	5.62	1.42
	15	14.70	5.03	2.93	11.84	5.56	2.13	9.04	6.05	1.49	8.44	6.08	1.39	8.44	6.08	1.39	8.44	6.08	1.39
	20	13.35	5.51	2.42	11.97	6.02	1.99	8.93	6.42	1.39	6.69	6.48	1.03	6.69	6.48	1.03	6.69	6.48	1.03
	25	13.23	6.00	2.21	11.8														

R290 M thermal Arctic HT Series



LWT	DB	Maximum			100%(Nonimal)			75%			50%			25%			Minimum		
		HC	COP	PI	HC	COP	PI	HC	COP	PI	HC	COP	PI	HC	COP	PI	HC	COP	PI
45	-25	6.64	1.63	4.08	6.64	1.63	4.08	6.64	1.63	4.08	5.04	1.69	2.97	3.16	1.77	1.79	3.16	1.77	1.79
	-20	8.18	1.90	4.31	8.18	1.90	4.31	7.74	1.92	4.02	5.20	1.98	2.63	4.07	2.14	1.90	4.07	2.14	1.90
	-15	9.85	2.18	4.51	9.85	2.18	4.51	7.75	2.27	3.42	5.26	2.30	2.29	4.52	2.37	1.90	4.52	2.37	1.90
	-10	10.13	2.20	4.59	10.13	2.20	4.59	7.86	2.32	3.39	5.35	2.62	2.04	5.19	2.69	1.93	5.19	2.69	1.93
	-7	10.50	2.45	4.29	10.50	2.45	4.29	7.97	2.66	3.00	5.86	2.98	1.97	5.86	2.98	1.97	5.86	2.98	1.97
	-5	10.49	2.46	4.27	10.49	2.46	4.27	8.14	2.71	3.00	6.02	3.01	2.00	6.02	3.01	2.00	6.02	3.01	2.00
	-2	11.03	2.64	4.18	10.71	2.67	4.01	8.09	2.87	2.82	6.29	3.18	1.98	6.29	3.18	1.98	6.29	3.18	1.98
	0	11.27	2.78	4.05	11.05	2.80	3.94	8.43	3.04	2.78	6.68	3.31	2.02	6.68	3.31	2.02	6.68	3.31	2.02
	2	11.58	2.89	4.01	11.30	2.90	3.90	8.36	3.20	2.61	7.00	3.42	2.04	7.00	3.42	2.04	7.00	3.42	2.04
	5	12.94	3.34	3.87	11.84	3.59	3.30	8.81	3.85	2.29	7.19	3.85	1.87	7.19	3.85	1.87	7.19	3.85	1.87
	7	14.06	3.66	3.84	12.00	3.70	3.24	8.92	4.15	2.15	7.98	4.26	1.88	7.98	4.26	1.88	7.98	4.26	1.88
	10	14.85	4.03	3.68	11.97	4.31	2.78	9.01	4.56	1.98	8.30	4.67	1.78	8.30	4.67	1.78	8.30	4.67	1.78
	12	15.17	4.32	3.51	11.90	4.63	2.57	8.95	4.80	1.86	8.60	4.84	1.78	8.60	4.84	1.78	8.60	4.84	1.78
	15	14.34	4.51	3.18	11.83	4.90	2.41	9.31	5.17	1.80	9.18	5.26	1.74	9.18	5.26	1.74	9.18	5.26	1.74
	20	13.11	4.93	2.66	11.98	5.32	2.25	8.98	5.56	1.61	7.42	5.61	1.32	7.42	5.61	1.32	7.42	5.61	1.32
	25	12.99	5.34	2.43	11.87	5.61	2.12	8.96	5.95	1.50	8.34	5.96	1.40	8.34	5.96	1.40	8.34	5.96	1.40
30	13.00	6.21	2.09	11.99	6.43	1.87	9.27	6.62	1.40	9.14	6.65	1.38	9.14	6.65	1.38	9.14	6.65	1.38	
35	12.81	7.19	1.78	11.93	7.28	1.64	10.01	7.48	1.34	10.01	7.48	1.34	10.01	7.48	1.34	10.01	7.48	1.34	
50	-25	6.46	1.52	4.26	6.46	1.52	4.26	6.46	1.52	4.26	5.24	1.58	3.32	3.36	1.63	2.06	3.36	1.63	2.06
	-20	7.99	1.77	4.51	7.99	1.77	4.51	7.77	1.78	4.37	5.18	1.93	2.69	4.32	1.98	2.18	4.32	1.98	2.18
	-15	9.67	1.90	5.09	9.67	1.90	5.09	7.77	2.06	3.78	5.28	2.09	2.52	4.79	2.17	2.21	4.79	2.17	2.21
	-10	10.07	2.05	4.91	10.07	2.05	4.91	7.92	2.19	3.62	5.42	2.44	2.22	5.42	2.44	2.22	5.42	2.44	2.22
	-7	10.42	2.24	4.66	10.42	2.24	4.66	7.83	2.39	3.28	6.11	2.66	2.30	6.11	2.66	2.30	6.11	2.66	2.30
	-5	10.27	2.27	4.52	10.27	2.27	4.52	8.01	2.42	3.31	6.31	2.71	2.33	6.31	2.71	2.33	6.31	2.71	2.33
	-2	10.78	2.43	4.43	10.78	2.43	4.43	8.25	2.59	3.19	6.85	2.83	2.42	6.85	2.83	2.42	6.85	2.83	2.42
	0	11.02	2.56	4.31	11.02	2.56	4.31	8.47	2.73	3.10	7.23	2.96	2.44	7.23	2.96	2.44	7.23	2.96	2.44
	2	11.32	2.68	4.23	11.32	2.68	4.23	8.38	2.90	2.90	7.58	3.08	2.46	7.58	3.08	2.46	7.58	3.08	2.46
	5	12.63	3.05	4.15	11.85	3.24	3.66	8.86	3.39	2.62	8.38	3.57	2.35	8.38	3.57	2.35	8.38	3.57	2.35
	7	13.69	3.33	4.11	12.08	3.45	3.50	9.10	3.61	2.52	8.95	3.78	2.37	8.95	3.78	2.37	8.95	3.78	2.37
	10	14.43	3.64	3.97	12.07	3.83	3.15	8.91	4.00	2.23	8.90	4.12	2.16	8.90	4.12	2.16	8.90	4.12	2.16
	12	14.74	3.89	3.79	11.96	4.12	2.90	9.38	4.32	2.17	9.38	4.32	2.17	9.38	4.32	2.17	9.38	4.32	2.17
	15	13.94	4.04	3.45	12.00	4.32	2.78	9.98	4.54	2.20	9.85	4.59	2.14	9.85	4.59	2.14	9.85	4.59	2.14
	20	12.87	4.42	2.91	11.93	4.71	2.53	8.98	4.88	1.84	7.74	4.89	1.58	7.74	4.89	1.58	7.74	4.89	1.58
	25	12.74	4.79	2.66	11.85	4.96	2.39	8.98	5.14	1.75	8.61	5.19	1.66	8.61	5.19	1.66	8.61	5.19	1.66
30	12.73	5.49	2.32	11.97	5.63	2.13	9.57	5.84	1.64	9.57	5.84	1.64	9.57	5.84	1.64	9.57	5.84	1.64	
35	12.53	6.28	1.99	11.94	6.32	1.89	10.34	6.41	1.61	10.34	6.41	1.61	10.34	6.41	1.61	10.34	6.41	1.61	
55	-25	6.35	1.43	4.44	6.35	1.43	4.44	6.35	1.43	4.44	5.14	1.49	3.46	3.71	1.53	2.43	3.71	1.53	2.43
	-20	7.93	1.69	4.70	7.93	1.69	4.70	7.81	1.69	4.63	5.11	1.74	2.93	4.73	1.85	2.55	4.73	1.85	2.55
	-15	9.62	1.94	4.96	9.62	1.94	4.96	7.92	1.99	3.99	5.39	2.06	2.62	5.39	2.06	2.62	5.39	2.06	2.62
	-10	10.06	1.98	5.09	10.06	1.98	5.09	7.95	2.05	3.88	6.01	2.28	2.64	6.01	2.28	2.64	6.01	2.28	2.64
	-7	10.40	2.15	4.84	10.40	2.15	4.84	8.01	2.22	3.61	6.53	2.32	2.82	6.53	2.32	2.82	6.53	2.32	2.82
	-5	10.24	2.16	4.75	10.24	2.16	4.75	7.99	2.25	3.55	6.80	2.40	2.83	6.80	2.40	2.83	6.80	2.40	2.83
	-2	10.69	2.29	4.67	10.69	2.29	4.67	8.36	2.39	3.50	6.91	2.58	2.68	6.91	2.58	2.68	6.91	2.58	2.68
	0	10.91	2.40	4.54	10.91	2.40	4.54	8.59	2.51	3.42	7.28	2.69	2.71	7.28	2.69	2.71	7.28	2.69	2.71
	2	11.30	2.55	4.43	11.30	2.55	4.43	8.51	2.67	3.19	7.64	2.80	2.73	7.64	2.80	2.73	7.64	2.80	2.73
	5	12.49	2.84	4.40	11.86	2.99	3.96	9.12	3.21	2.84	9.12	3.21	2.84	9.12	3.21	2.84	9.12	3.21	2.84
	7	13.61	3.11	4.37	12.00	3.10	3.87	9.75	3.39	2.88	9.75	3.39	2.88	9.75	3.39	2.88	9.75	3.39	2.88
	10	14.25	3.37	4.23	12.08	3.52	3.43	9.05	3.70	2.44	9.05	3.70	2.44	9.05	3.70	2.44	9.05	3.70	2.44
	12	14.54	3.59	4.05	11.96	3.75	3.19	9.59	3.90	2.46	9.59	3.90	2.46	9.59	3.90	2.46	9.59	3.90	2.46
	15	13.74	3.71	3.71	11.92	3.90	3.06	10.36	4.13	2.51	10.06	4.14	2.43	10.06	4.14	2.43	10.06	4.14	2.43
	20	12.80	4.05	3.16	11.87	4.20	2.83	9.13	4.43	2.06	7.98	4.46	1.79	7.98	4.46	1.79	7.98	4.46	1.79
	25	12.67	4.39	2.88	11.99	4.50	2.66	9.15	4.74	1.93	9.12	4.77	1.91	9.12	4.77	1.91	9.12	4.77	1.91
30	12.64	5.02	2.52	11.88	5.13	2.32	9.92	5.19	1.91	9.92	5.19	1.91	9.92	5.19	1.91	9.92	5.19	1.91	
35	12.42	5.57	2.23	11.85	5.67	2.09	10.78	5.69	1.89	10.78	5.69	1.89	10.78	5.69	1.89	10.78	5.69	1.89	
60	-25	/	/	/	/	/	/	/	/	/	/	/	/	/	/	/	/	/	/
	-20	7.69	1.56	4.93	7.69	1.56	4.93	7.69	1.56	4.93	5.14	1.66	3.10	4.92	1.68	2.92	4.92	1.68	2.92
	-15	9.38	1.75	5.35	9.38	1.75	5.35	7.90	1.83	4.32	5.70	1.88	3.03	5.70	1.88	3.03	5.70	1.88	3.03
	-10	10.01	1.87	5.36	10.01	1.87	5.36	8.04	1.94	4.14	6.39	2.12	3.01	6.39	2.12	3.01	6.39	2.12	3.01
	-7	10.35	1.99	5.20	10.35	1.99	5.20	7.78	2.09	3.72	7.54	2.17	3.47	7.54	2.17	3.47	7.54	2.17	3.47
	-5	10.15	2.02	5.03	10.15	2.02	5.03	7.96	2.12	3.75	7.08	2.25	3.15	7.08	2.25	3.15	7.08	2.25	3.15
	-2	10.44	2.11	4.96	10.44	2.11	4.96	8.18	2.15	3.80	7.12	2.31	3.08	7.12	2.31	3.08	7.12	2.31	3.08
	0	10.59	2.19	4.84	10.59	2.19	4.84	8.41	2.27	3.71	7.52	2.41	3.12	7.52	2.41	3.12	7.52	2.41	3.12
	2	10.87	2.28	4.77	10.87	2.28	4.77	8.46	2.39	3.54	7.89	2.51	3.15	7.89	2.51	3.15	7.89	2.51	3.15
	5	12.75	2.65	4.81	11.76	2.68	4.38	8.91	2.87	3.10	8.91	2.87	3.10	8.91	2.87	3.10	8.91	2.87	3.10
	7	13.13	2.84	4.62	12.06	2.88	4.18	9.55	3.04	3.14	9.55	3.04	3.14	9.55	3.04	3.14	9.55	3.04	3.14
	10	13.75	3.03	4.54	12.01	3.12	3.85	9.12	3.29	2.77	9.12	3.29	2.77	9.12	3.29	2.77	9.12	3.29	2.77
	12	14.03	3.22	4.36	12.18	3.32	3.67	9.66	3.45	2.80	9.66	3.45	2.80	9.66	3.45	2.80	9.66	3.45	2.80
	15	13.28	3.33	3.99	12.03	3.46	3.48	10.19	3.68	2.77	10.19	3.68	2.77	10.19	3.68	2.77	10.19	3.68	2.77
	20	12.49	3.64	3.43	11.98	3.71	3.23	9.09	3.88	2.34	8.16	3.96	2.06						

LWT	DB	Maximum			100%(Nonimal)			75%			50%			25%			Minimum		
		HC	COP	PI	HC	COP	PI	HC	COP	PI	HC	COP	PI	HC	COP	PI	HC	COP	PI
65	-25	/	/	/	/	/	/	/	/	/	/	/	/	/	/	/	/	/	/
	-20	7.42	1.43	5.19	7.42	1.43	5.19	7.42	1.43	5.19	5.15	1.45	3.54	4.66	1.51	3.08	4.66	1.51	3.08
	-15	8.99	1.60	5.61	8.99	1.60	5.61	7.85	1.68	4.68	5.64	1.79	3.15	5.64	1.79	3.15	5.64	1.79	3.15
	-10	9.76	1.78	5.48	9.76	1.78	5.48	8.07	1.82	4.43	6.46	2.01	3.22	6.46	2.01	3.22	6.46	2.01	3.22
	-7	10.27	1.83	5.61	10.27	1.83	5.61	7.88	1.93	4.08	6.68	2.02	3.31	6.68	2.02	3.31	6.68	2.02	3.31
	-5	9.83	1.86	5.28	9.83	1.86	5.28	7.93	1.99	3.98	6.94	2.06	3.37	6.94	2.06	3.37	6.94	2.06	3.37
	-2	10.06	1.96	5.14	10.06	1.96	5.14	8.09	2.04	3.97	6.90	2.10	3.29	6.90	2.10	3.29	6.90	2.10	3.29
	0	9.97	2.01	4.96	9.97	2.01	4.96	8.19	2.07	3.95	7.22	2.16	3.34	7.22	2.16	3.34	7.22	2.16	3.34
	2	10.37	2.06	5.03	10.37	2.06	5.03	8.36	2.12	3.94	7.57	2.24	3.38	7.57	2.24	3.38	7.57	2.24	3.38
	5	12.26	2.39	5.14	11.77	2.39	4.91	8.74	2.47	3.55	8.52	2.56	3.32	8.52	2.56	3.32	8.52	2.56	3.32
	7	12.53	2.59	4.84	12.02	2.63	4.58	9.06	2.79	3.25	9.06	2.79	3.25	9.06	2.79	3.25	9.06	2.79	3.25
	10	13.19	2.71	4.87	12.07	2.78	4.34	9.01	2.90	3.11	8.74	2.92	2.99	8.74	2.92	2.99	8.74	2.92	2.99
	12	13.45	2.87	4.69	12.04	2.93	4.11	9.28	3.07	3.03	9.28	3.07	3.03	9.28	3.07	3.03	9.28	3.07	3.03
	15	12.73	2.96	4.31	11.88	3.06	3.88	10.16	3.28	3.10	9.84	3.28	3.00	9.84	3.28	3.00	9.84	3.28	3.00
	20	12.14	3.24	3.75	11.84	3.30	3.59	9.02	3.53	2.55	7.87	3.53	2.23	7.87	3.53	2.23	7.87	3.53	2.23
	25	11.99	3.52	3.41	11.99	3.52	3.41	9.14	3.78	2.42	9.14	3.78	2.42	9.14	3.78	2.42	9.14	3.78	2.42
30	11.95	3.96	3.02	11.95	3.96	3.02	9.92	4.07	2.44	9.92	4.07	2.44	9.92	4.07	2.44	9.92	4.07	2.44	
35	/	/	/	/	/	/	/	/	/	/	/	/	/	/	/	/	/	/	
70	-25	/	/	/	/	/	/	/	/	/	/	/	/	/	/	/	/	/	
	-20	/	/	/	/	/	/	/	/	/	/	/	/	/	/	/	/	/	
	-15	8.45	1.57	5.40	8.45	1.57	5.40	7.90	1.61	4.92	5.47	1.65	3.32	5.47	1.65	3.32	5.47	1.65	3.32
	-10	9.40	1.72	5.47	9.40	1.72	5.47	8.38	1.75	4.80	6.50	1.92	3.40	6.50	1.92	3.40	6.50	1.92	3.40
	-7	9.86	1.80	5.47	9.86	1.80	5.47	8.00	1.85	4.33	7.04	1.96	3.59	6.90	1.96	3.52	6.90	1.96	3.52
	-5	9.52	1.82	5.24	9.52	1.82	5.24	8.04	1.87	4.30	7.13	1.97	3.61	7.13	1.97	3.61	7.13	1.97	3.61
	-2	9.71	1.85	5.24	9.71	1.85	5.24	8.31	1.89	4.40	6.98	2.00	3.49	6.98	2.00	3.49	6.98	2.00	3.49
	0	9.56	1.89	5.06	9.56	1.89	5.06	8.39	1.99	4.22	7.26	2.05	3.54	7.26	2.05	3.54	7.26	2.05	3.54
	2	10.04	1.93	5.19	10.04	1.93	5.19	8.43	2.03	4.15	7.53	2.09	3.60	7.53	2.09	3.60	7.53	2.09	3.60
	5	11.62	2.19	5.32	11.62	2.19	5.32	8.81	2.36	3.74	8.44	2.38	3.55	8.44	2.38	3.55	8.44	2.38	3.55
	7	12.22	2.29	5.32	12.05	2.30	5.24	8.89	2.50	3.56	8.72	2.52	3.45	8.72	2.52	3.45	8.72	2.52	3.45
	10	12.49	2.48	5.03	11.91	2.52	4.72	9.08	2.66	3.41	8.67	2.70	3.22	8.67	2.70	3.22	8.67	2.70	3.22
	12	13.09	2.60	5.03	11.88	2.66	4.47	9.24	2.84	3.26	9.24	2.84	3.26	9.24	2.84	3.26	9.24	2.84	3.26
	15	12.39	2.78	4.45	11.88	2.83	4.20	9.82	3.04	3.23	9.82	3.04	3.23	9.82	3.04	3.23	9.82	3.04	3.23
	20	11.95	2.95	4.05	11.95	2.95	4.05	9.07	3.17	2.86	7.87	3.28	2.40	7.87	3.28	2.40	7.87	3.28	2.40
	25	11.82	3.21	3.68	11.82	3.21	3.68	9.21	3.51	2.62	9.21	3.51	2.62	9.21	3.51	2.62	9.21	3.51	2.62
30	/	/	/	/	/	/	/	/	/	/	/	/	/	/	/	/	/	/	
35	/	/	/	/	/	/	/	/	/	/	/	/	/	/	/	/	/	/	
75	-25	/	/	/	/	/	/	/	/	/	/	/	/	/	/	/	/	/	
	-20	/	/	/	/	/	/	/	/	/	/	/	/	/	/	/	/	/	
	-15	/	/	/	/	/	/	/	/	/	/	/	/	/	/	/	/	/	
	-10	8.97	1.48	6.05	8.97	1.48	6.05	8.23	1.58	5.21	6.26	1.74	3.61	6.26	1.74	3.61	6.26	1.74	3.61
	-7	9.18	1.63	5.64	9.18	1.63	5.64	7.98	1.71	4.67	6.84	1.80	3.80	6.84	1.80	3.80	6.84	1.80	3.80
	-5	8.79	1.68	5.23	8.79	1.68	5.23	8.02	1.72	4.67	6.99	1.83	3.82	6.99	1.83	3.82	6.99	1.83	3.82
	-2	8.89	1.70	5.23	8.89	1.70	5.23	8.23	1.74	4.72	6.92	1.85	3.73	6.92	1.85	3.73	6.92	1.85	3.73
	0	8.83	1.74	5.09	8.83	1.74	5.09	8.43	1.79	4.72	7.19	1.90	3.79	7.19	1.90	3.79	7.19	1.90	3.79
	2	9.26	1.76	5.25	9.26	1.76	5.25	8.45	1.83	4.61	7.42	1.92	3.86	7.42	1.92	3.86	7.42	1.92	3.86
	5	10.51	1.97	5.33	10.51	1.97	5.33	8.79	2.08	4.23	8.12	2.13	3.82	8.12	2.13	3.82	8.12	2.13	3.82
	7	10.89	2.03	5.35	10.89	2.01	5.41	9.02	2.10	4.30	8.26	2.14	3.85	8.26	2.14	3.85	8.26	2.14	3.85
	10	11.27	2.20	5.13	11.27	2.20	5.13	9.06	2.32	3.90	8.36	2.41	3.47	8.36	2.41	3.47	8.36	2.41	3.47
	12	12.01	2.31	5.21	11.82	2.31	5.11	9.12	2.47	3.69	8.91	2.54	3.51	8.91	2.54	3.51	8.91	2.54	3.51
	15	11.73	2.48	4.73	11.73	2.48	4.73	9.54	2.72	3.51	9.54	2.72	3.51	9.54	2.72	3.51	9.54	2.72	3.51
	20	11.12	2.64	4.21	11.12	2.64	4.21	9.09	2.84	3.20	7.64	2.90	2.64	7.64	2.90	2.64	7.64	2.90	2.64
	25	/	/	/	/	/	/	/	/	/	/	/	/	/	/	/	/	/	/
30	/	/	/	/	/	/	/	/	/	/	/	/	/	/	/	/	/	/	
35	/	/	/	/	/	/	/	/	/	/	/	/	/	/	/	/	/	/	

Abbreviations:

LWT: Leaving water temperature (°C)

DB: Dry-bulb temperature for Outdoor air temperature (°C)

HC: Total heating capacity (kW)

PI: Power input (kW)

R290 M thermal Arctic HT Series



14kW Heating Capacity

LWT	DB	Maximum			100%(Nonimal)			75%			50%			25%			Minimum		
		HC	COP	PI	HC	COP	PI	HC	COP	PI	HC	COP	PI	HC	COP	PI	HC	COP	PI
25	-25	8.42	2.18	3.87	8.42	2.18	3.87	8.42	2.18	3.87	5.74	2.40	2.40	2.98	2.56	1.17	2.98	2.56	1.17
	-20	10.04	2.48	4.04	10.04	2.48	4.04	8.57	2.69	3.19	5.61	2.89	1.94	3.77	3.11	1.21	3.77	3.11	1.21
	-15	11.52	2.77	4.16	11.52	2.77	4.16	8.55	3.19	2.68	5.60	3.41	1.64	4.37	3.77	1.16	4.37	3.77	1.16
	-10	12.24	2.90	4.22	11.59	2.95	3.93	8.58	3.38	2.54	5.83	3.69	1.58	4.69	3.99	1.18	4.69	3.99	1.18
	-7	12.49	3.06	4.09	11.40	3.29	3.47	8.55	3.93	2.17	5.73	4.38	1.31	5.41	4.44	1.22	5.41	4.44	1.22
	-5	12.71	3.27	3.89	11.35	3.46	3.28	8.54	3.94	2.17	5.60	4.55	1.23	5.60	4.55	1.23	5.60	4.55	1.23
	-2	13.13	3.58	3.67	11.12	3.90	2.85	8.49	4.42	1.92	5.53	4.92	1.13	4.86	5.22	0.93	4.86	5.22	0.93
	0	13.32	3.80	3.50	10.82	4.28	2.53	8.37	4.76	1.76	5.40	5.36	1.01	5.02	5.42	0.93	5.02	5.42	0.93
	2	13.53	4.03	3.36	10.81	4.64	2.33	8.06	5.11	1.58	5.54	5.72	0.97	5.38	5.80	0.93	5.38	5.80	0.93
	5	15.22	4.68	3.25	12.76	5.26	2.42	9.53	6.13	1.55	6.35	6.94	0.91	5.85	7.00	0.84	5.85	7.00	0.84
	7	16.96	5.23	3.24	13.97	5.88	2.38	10.49	6.55	1.60	6.99	7.42	0.94	6.24	7.44	0.84	6.24	7.44	0.84
	10	18.26	6.13	2.98	14.12	7.28	1.94	10.55	8.00	1.32	7.25	8.95	0.81	7.25	8.95	0.81	7.25	8.95	0.81
	12	18.97	6.64	2.86	14.04	8.00	1.75	10.45	8.90	1.17	7.71	9.79	0.79	7.71	9.79	0.79	7.71	9.79	0.79
	15	17.72	7.06	2.51	13.93	8.15	1.71	10.58	9.26	1.14	7.78	10.26	0.76	7.78	10.26	0.76	7.78	10.26	0.76
	20	15.66	8.00	1.96	13.97	8.66	1.61	10.45	10.28	1.02	6.95	11.20	0.62	6.62	11.24	0.59	6.62	11.24	0.59
	25	15.59	8.79	1.77	13.92	9.59	1.45	10.55	11.10	0.95	7.40	11.79	0.63	7.40	11.79	0.63	7.40	11.79	0.63
30	/	/	/	/	/	/	/	/	/	/	/	/	/	/	/	/	/	/	/
35	/	/	/	/	/	/	/	/	/	/	/	/	/	/	/	/	/	/	/
30	-25	7.97	1.97	4.05	7.97	1.97	4.05	7.97	1.97	4.05	5.53	2.10	2.63	2.78	2.25	1.24	2.78	2.25	1.24
	-20	9.57	2.25	4.25	9.57	2.25	4.25	8.37	2.38	3.52	5.59	2.54	2.20	3.56	2.76	1.29	3.56	2.76	1.29
	-15	10.92	2.51	4.34	10.92	2.51	4.34	8.48	2.84	2.99	5.63	3.00	1.88	4.19	3.36	1.25	4.19	3.36	1.25
	-10	11.57	2.62	4.42	11.57	2.62	4.42	8.59	2.96	2.90	5.84	3.24	1.80	4.58	3.58	1.28	4.58	3.58	1.28
	-7	12.30	2.84	4.33	11.60	3.05	3.80	8.47	3.45	2.46	5.80	3.84	1.51	5.39	4.03	1.34	5.39	4.03	1.34
	-5	12.24	2.96	4.14	11.11	3.16	3.52	8.39	3.52	2.38	5.60	3.85	1.45	5.38	4.10	1.31	5.38	4.10	1.31
	-2	12.65	3.23	3.92	10.90	3.46	3.15	8.33	3.87	2.15	5.57	4.18	1.33	4.66	4.56	1.02	4.66	4.56	1.02
	0	12.84	3.43	3.74	10.87	3.72	2.93	8.26	4.15	1.99	5.47	4.52	1.21	4.74	4.63	1.02	4.74	4.63	1.02
	2	13.04	3.62	3.60	10.62	4.04	2.63	8.05	4.47	1.80	5.46	4.82	1.13	5.16	5.02	1.03	5.16	5.02	1.03
	5	14.66	4.20	3.50	12.70	4.55	2.79	9.56	5.25	1.82	6.42	5.75	1.12	5.54	5.92	0.93	5.54	5.92	0.93
	7	16.25	4.66	3.48	14.10	5.01	2.82	10.58	5.58	1.89	7.07	6.16	1.15	5.98	6.33	0.94	5.98	6.33	0.94
	10	17.24	5.39	3.20	13.93	6.19	2.25	10.46	6.73	1.55	6.91	7.52	0.92	6.91	7.52	0.92	6.91	7.52	0.92
	12	18.09	5.84	3.10	14.05	6.76	2.08	10.43	7.41	1.41	7.32	8.10	0.90	7.32	8.10	0.90	7.32	8.10	0.90
	15	16.91	6.15	2.75	13.94	6.98	2.00	10.44	7.77	1.34	7.59	8.73	0.87	7.59	8.73	0.87	7.59	8.73	0.87
	20	15.03	6.94	2.17	13.82	7.53	1.83	10.51	8.56	1.23	6.92	9.26	0.75	6.37	9.36	0.68	6.37	9.36	0.68
	25	15.04	7.58	1.98	14.13	7.93	1.78	10.39	9.18	1.13	7.11	9.62	0.74	7.11	9.62	0.74	7.11	9.62	0.74
30	14.61	9.22	1.58	14.12	9.53	1.48	10.47	10.81	0.97	7.78	11.27	0.69	7.78	11.27	0.69	7.78	11.27	0.69	
35	/	/	/	/	/	/	/	/	/	/	/	/	/	/	/	/	/	/	/
35	-25	7.78	1.85	4.22	7.78	1.85	4.22	7.78	1.85	4.22	5.58	1.92	2.91	2.68	2.02	1.33	2.68	2.02	1.33
	-20	9.38	2.11	4.45	9.38	2.11	4.45	8.42	2.19	3.84	5.61	2.31	2.43	3.47	2.50	1.39	3.47	2.50	1.39
	-15	10.75	2.35	4.57	10.75	2.35	4.57	8.63	2.61	3.31	5.71	2.75	2.07	4.16	2.97	1.40	4.16	2.97	1.40
	-10	11.34	2.42	4.68	11.34	2.42	4.68	8.69	2.69	3.23	6.03	3.14	1.92	4.50	3.28	1.37	4.50	3.28	1.37
	-7	12.05	2.62	4.59	11.50	2.70	4.26	8.60	3.03	2.84	5.76	3.50	1.64	5.25	3.58	1.47	5.25	3.58	1.47
	-5	12.03	2.74	4.39	11.27	2.82	3.99	8.43	3.12	2.70	5.68	3.58	1.59	5.08	3.62	1.40	5.08	3.62	1.40
	-2	12.45	2.99	4.16	10.92	3.15	3.47	8.39	3.50	2.40	5.69	3.73	1.53	4.57	4.12	1.11	4.57	4.12	1.11
	0	12.63	3.17	3.99	11.14	3.35	3.33	8.34	3.72	2.24	5.46	4.01	1.36	4.73	4.33	1.09	4.73	4.33	1.09
	2	12.84	3.35	3.83	10.80	3.50	3.09	8.23	3.98	2.07	5.45	4.24	1.28	5.07	4.50	1.13	5.07	4.50	1.13
	5	14.43	3.85	3.75	12.60	4.11	3.07	9.51	4.69	2.03	6.42	5.04	1.28	5.36	5.18	1.03	5.36	5.18	1.03
	7	15.95	4.26	3.74	14.00	4.50	3.11	10.53	4.97	2.12	7.07	5.38	1.32	5.87	5.61	1.05	5.87	5.61	1.05
	10	16.52	4.76	3.47	13.53	5.27	2.57	10.31	5.63	1.83	6.96	6.15	1.13	6.42	6.22	1.03	6.42	6.22	1.03
	12	17.19	5.13	3.35	13.98	5.72	2.44	10.41	6.12	1.70	7.10	6.64	1.07	6.82	6.71	1.02	6.82	6.71	1.02
	15	16.04	5.36	2.99	13.98	5.85	2.39	10.46	6.39	1.64	7.09	7.20	0.99	7.09	7.20	0.99	7.09	7.20	0.99
	20	14.32	6.15	2.33	14.13	6.47	2.18	10.36	7.26	1.43	6.93	7.84	0.88	5.97	7.99	0.75	5.97	7.99	0.75
	25	14.32	6.82	2.10	13.88	6.96	1.99	10.35	7.98	1.30	7.01	8.32	0.84	6.68	8.47	0.79	6.68	8.47	0.79
30	13.95	7.83	1.78	13.95	7.83	1.78	10.45	8.73	1.20	7.30	9.00	0.81	7.30	9.00	0.81	7.30	9.00	0.81	
35	13.22	9.58	1.38	13.22	9.58	1.38	10.47	10.32	1.01	7.97	10.45	0.76	7.97	10.45	0.76	7.97	10.45	0.76	
40	-25	7.59	1.70	4.47	7.59	1.70	4.47	7.59	1.70	4.47	5.82	1.78	3.28	2.74	1.89	1.45	2.74	1.89	1.45
	-20	9.22	1.98	4.65	9.22	1.98	4.65	8.57	2.02	4.24	5.67	2.11	2.68	3.57	2.31	1.55	3.57	2.31	1.55
	-15	10.70	2.20	4.86	10.60	2.23	4.76	8.77	2.35	3.74	5.66	2.47	2.29	3.99	2.59	1.54	3.99	2.59	1.54
	-10	11.11	2.25	4.94	11.11	2.25	4.94	8.79	2.46	3.57	6.02	2.86	2.11	4.63	2.98	1.55	4.63	2.98	1.55
	-7	11.84	2.44	4.85	11.44	2.50	4.57	8.60	2.90	2.97	5.71	3.24	1.76	5.36	3.39	1.58	5.36	3.39	1.58
	-5	11.80	2.54	4.65	11.45	2.58	4.44	8.47	2.96	2.87	5.76	3.29	1.75	5.43	3.45	1.57	5.43	3.45	1.57
	-2	12.22	2.77	4.42	11.15	2.87	3.89	8.47	3.15	2.69	5.79	3.33	1.74	5.34	3.62	1.47	5.34	3.62	1.47
	0	12.42	2.93	4.24	11.28	3.05	3.70	8.42	3.36	2.51	5.63	3.78	1.49	5.63	3.78	1.49	5.63	3.78	1.49
	2	12.62	3.09	4.08	11.10	3.26	3.40	8.35	3.57	2.34	5.90	3.92	1.51	5.90	3.92	1.51	5.90	3.92	1.51
	5	14.17	3.54	4.00	12.93	3.68	3.51	9.61	4.18	2.30	6.70	4.38	1.53	6.70	4.38	1.53	6.70	4.38	1.53
	7	15.63	3.90	4.01	14.06	4.07	3.46	10.43	4.42	2.36	7.38	4.82	1.53	7.38	4.82	1.53	7.38	4.82	1.53
	10	16.17	4.32	3.74	13.81	4.63	2.99	10.45	4.97	2.10	7.64	5.36	1.43	7.64	5.36	1.43	7.64	5.36	1.43
	12	16.81	4.64	3.63	14.07	5.04	2.79	10.58	5.36	1.98	7.98	5.62	1.42	7.98	5.62	1.42	7.98	5.62	1.42
	15	15.71	4.84	3.25	14.08	5.14	2.74	10.64	5.66	1.88	8.44	6.08	1.39	8.44	6.08	1.39	8.44	6.08	1.39
	20	14.12	5.37	2.63	13.93	5.52	2.52	10.39	6.15	1.69	6.69	6.48	1.03	6.69	6.48	1.03	6.69	6.48	1.03

LWT	DB	Maximum			100%(Nonimal)			75%			50%			25%			Minimum		
		HC	COP	PI	HC	COP	PI	HC	COP	PI	HC	COP	PI	HC	COP	PI	HC	COP	PI
		45	-25	7.41	1.58	4.69	7.41	1.58	4.69	7.41	1.56	4.75	5.53	1.65	3.35	3.16	1.77	1.79	3.16
-20	9.02		1.85	4.87	9.02	1.85	4.87	8.62	1.88	4.58	5.68	2.01	2.83	4.07	2.14	1.90	4.07	2.14	1.90
-15	10.67		2.09	5.11	10.67	2.09	5.11	8.69	2.15	4.04	5.70	2.26	2.52	4.52	2.37	1.90	4.52	2.37	1.90
-10	10.95		2.10	5.21	10.95	2.10	5.21	8.75	2.26	3.87	5.89	2.58	2.28	5.19	2.69	1.93	5.19	2.69	1.93
-7	11.40		2.30	4.96	11.40	2.30	4.96	8.61	2.59	3.32	5.86	2.98	1.97	5.86	2.98	1.97	5.86	2.98	1.97
-5	11.58		2.35	4.92	11.58	2.35	4.92	8.49	2.67	3.18	6.02	3.01	2.00	6.02	3.01	2.00	6.02	3.01	2.00
-2	11.99		2.55	4.69	11.72	2.58	4.54	8.63	2.83	3.04	6.29	3.18	1.98	6.29	3.18	1.98	6.29	3.18	1.98
0	12.19		2.71	4.50	11.38	2.77	4.11	8.86	3.00	2.95	6.68	3.31	2.02	6.68	3.31	2.02	6.68	3.31	2.02
2	12.38		2.85	4.35	12.00	2.85	4.21	9.04	3.17	2.85	7.00	3.42	2.04	7.00	3.42	2.04	7.00	3.42	2.04
5	13.90		3.25	4.28	13.22	3.32	3.99	9.87	3.75	2.63	7.19	3.85	1.87	7.19	3.85	1.87	7.19	3.85	1.87
7	15.27		3.56	4.29	14.00	3.50	4.00	10.51	3.96	2.66	7.98	4.26	1.88	7.98	4.26	1.88	7.98	4.26	1.88
10	15.78		3.92	4.02	14.06	4.11	3.42	10.56	4.40	2.40	8.30	4.67	1.78	8.30	4.67	1.78	8.30	4.67	1.78
12	16.40		4.19	3.91	14.11	4.44	3.18	10.61	4.66	2.28	8.60	4.84	1.78	8.60	4.84	1.78	8.60	4.84	1.78
15	15.34		4.36	3.52	14.14	4.55	3.11	10.64	5.04	2.11	9.18	5.26	1.74	9.18	5.26	1.74	9.18	5.26	1.74
20	13.89		4.79	2.90	13.89	4.79	2.90	10.41	5.37	1.94	7.42	5.61	1.32	7.42	5.61	1.32	7.42	5.61	1.32
25	13.87		5.17	2.68	13.87	5.17	2.68	10.45	5.82	1.79	8.34	5.96	1.40	8.34	5.96	1.40	8.34	5.96	1.40
30	13.49		6.06	2.23	13.49	6.06	2.23	10.64	6.54	1.63	9.14	6.65	1.38	9.14	6.65	1.38	9.14	6.65	1.38
35	12.81	7.19	1.78	12.81	7.19	1.78	10.45	7.47	1.40	10.01	7.48	1.34	10.01	7.48	1.34	10.01	7.48	1.34	
50	-25	7.22	1.47	4.90	7.22	1.47	4.90	7.22	1.47	4.90	5.87	1.55	3.78	3.36	1.63	2.06	3.36	1.63	2.06
	-20	8.85	1.74	5.08	8.85	1.74	5.08	8.63	1.75	4.95	5.67	1.90	1.78	4.32	1.98	2.18	4.32	1.98	2.18
	-15	10.62	1.85	5.74	10.62	1.85	5.74	8.56	2.02	4.24	5.87	2.08	2.82	4.79	2.17	2.21	4.79	2.17	2.21
	-10	10.90	1.99	5.48	10.90	1.99	5.48	8.65	2.12	4.09	5.42	2.44	2.22	5.42	2.44	2.22	5.42	2.44	2.22
	-7	11.36	2.12	5.36	11.36	2.12	5.36	8.56	2.33	3.68	6.11	2.66	2.30	6.11	2.66	2.30	6.11	2.66	2.30
	-5	11.33	2.17	5.21	11.33	2.17	5.21	8.47	2.38	3.56	6.31	2.71	2.33	6.31	2.71	2.33	6.31	2.71	2.33
	-2	11.75	2.36	4.98	11.75	2.36	4.98	8.75	2.56	3.42	6.85	2.83	2.42	6.85	2.83	2.42	6.85	2.83	2.42
	0	11.93	2.50	4.78	11.93	2.50	4.78	8.85	2.70	3.28	7.23	2.96	2.44	7.23	2.96	2.44	7.23	2.96	2.44
	2	12.12	2.62	4.63	11.89	2.63	4.52	8.92	2.84	3.14	7.58	3.08	2.46	7.58	3.08	2.46	7.58	3.08	2.46
	5	13.59	2.98	4.56	13.32	3.00	4.45	9.95	3.34	2.98	8.38	3.57	2.35	8.38	3.57	2.35	8.38	3.57	2.35
	7	14.90	3.25	4.58	14.03	3.30	4.25	10.36	3.54	2.92	8.95	3.78	2.37	8.95	3.78	2.37	8.95	3.78	2.37
	10	15.37	3.57	4.31	14.05	3.67	3.83	10.61	3.90	2.72	8.90	4.12	2.16	8.90	4.12	2.16	8.90	4.12	2.16
	12	15.95	3.78	4.22	13.90	3.96	3.51	10.47	4.20	2.50	9.38	4.32	2.17	9.38	4.32	2.17	9.38	4.32	2.17
	15	14.94	3.93	3.80	14.14	4.01	3.52	10.72	4.38	2.45	9.85	4.59	2.14	9.85	4.59	2.14	9.85	4.59	2.14
	20	13.65	4.30	3.17	13.65	4.34	3.14	10.39	4.74	2.19	7.74	4.89	1.58	7.74	4.89	1.58	7.74	4.89	1.58
	25	13.61	4.63	2.94	13.61	4.63	2.94	10.30	5.00	2.06	8.61	5.19	1.66	8.61	5.19	1.66	8.61	5.19	1.66
	30	13.22	5.39	2.45	13.22	5.39	2.45	10.39	5.74	1.81	9.57	5.84	1.64	9.57	5.84	1.64	9.57	5.84	1.64
35	12.53	6.28	1.99	12.53	6.28	1.99	10.34	6.41	1.61	10.34	6.41	1.61	10.34	6.41	1.61	10.34	6.41	1.61	
55	-25	7.14	1.41	5.08	7.14	1.41	5.08	7.14	1.41	5.08	5.87	1.47	4.00	3.71	1.53	2.43	3.71	1.53	2.43
	-20	8.78	1.66	5.28	8.78	1.66	5.28	8.56	1.66	5.14	5.89	1.80	3.26	4.73	1.85	2.55	4.73	1.85	2.55
	-15	10.58	1.88	5.62	10.58	1.88	5.62	8.51	1.94	4.38	5.89	2.03	2.91	5.39	2.06	2.62	5.39	2.06	2.62
	-10	10.79	1.93	5.58	10.79	1.93	5.58	8.72	2.01	4.34	6.01	2.28	2.64	6.01	2.28	2.64	6.01	2.28	2.64
	-7	11.30	2.10	5.38	11.30	2.10	5.38	8.66	2.18	3.97	6.53	2.32	2.82	6.53	2.32	2.82	6.53	2.32	2.82
	-5	11.12	2.14	5.21	11.12	2.14	5.21	8.57	2.22	3.87	6.80	2.40	2.83	6.80	2.40	2.83	6.80	2.40	2.83
	-2	11.64	2.22	5.24	11.64	2.22	5.24	8.86	2.37	3.74	6.91	2.58	2.68	6.91	2.58	2.68	6.91	2.58	2.68
	0	11.83	2.35	5.04	11.83	2.35	5.04	8.98	2.50	3.60	7.28	2.69	2.71	7.28	2.69	2.71	7.28	2.69	2.71
	2	12.00	2.50	4.80	12.00	2.50	4.80	9.06	2.62	3.46	7.64	2.80	2.73	7.64	2.80	2.73	7.64	2.80	2.73
	5	13.46	2.79	4.83	13.33	2.80	4.77	9.72	3.08	3.15	9.12	3.21	2.84	9.12	3.21	2.84	9.12	3.21	2.84
	7	14.81	3.04	4.87	14.00	3.00	4.67	10.46	3.23	3.24	9.75	3.39	2.88	9.75	3.39	2.88	9.75	3.39	2.88
	10	15.19	3.31	4.59	14.05	3.38	4.16	10.63	3.56	2.98	9.05	3.70	2.44	9.05	3.70	2.44	9.05	3.70	2.44
	12	15.75	3.50	4.50	13.93	3.64	3.83	10.50	3.81	2.75	9.59	3.90	2.46	9.59	3.90	2.46	9.59	3.90	2.46
	15	14.75	3.63	4.07	14.16	3.68	3.85	10.55	4.05	2.61	10.06	4.14	2.43	10.06	4.14	2.43	10.06	4.14	2.43
	20	13.59	3.97	3.43	13.59	4.00	3.40	10.52	4.31	2.44	7.98	4.46	1.79	7.98	4.46	1.79	7.98	4.46	1.79
	25	13.54	4.27	3.17	13.54	4.27	3.17	10.61	4.69	2.26	9.12	4.77	1.91	9.12	4.77	1.91	9.12	4.77	1.91
	30	13.13	4.91	2.67	13.13	4.91	2.67	10.76	5.13	2.10	9.92	5.19	1.91	9.92	5.19	1.91	9.92	5.19	1.91
35	12.42	5.57	2.23	12.42	5.57	2.23	10.78	5.69	1.89	10.78	5.69	1.89	10.78	5.69	1.89	10.78	5.69	1.89	
60	-25	/	/	/	/	/	/	/	/	/	/	/	/	/	/	/	/	/	/
	-20	8.54	1.54	5.55	8.54	1.54	5.55	8.33	1.54	5.39	5.86	1.64	3.57	4.92	1.68	2.92	4.92	1.68	2.92
	-15	10.11	1.70	5.94	10.11	1.70	5.94	8.45	1.76	4.80	5.70	1.88	3.03	5.70	1.88	3.03	5.70	1.88	3.03
	-10	10.52	1.84	5.71	10.52	1.84	5.71	8.65	1.92	4.51	6.39	2.12	3.01	6.39	2.12	3.01	6.39	2.12	3.01
	-7	11.24	1.95	5.75	11.24	1.95	5.75	8.68	2.04	4.26	7.54	2.17	3.47	7.54	2.17	3.47	7.54	2.17	3.47
	-5	10.65	1.99	5.35	10.65	1.99	5.35	8.67	2.08	4.18	7.08	2.25	3.15	7.08	2.25	3.15	7.08	2.25	3.15
	-2	11.17	2.07	5.39	11.17	2.07	5.39	8.79	2.14	4.10	7.12	2.31	3.08	7.12	2.31	3.08	7.12	2.31	3.08
	0	11.52	2.15	5.36	11.52	2.15	5.36	8.92	2.25	3.96	7.52	2.41	3.12	7.52	2.41	3.12	7.52	2.41	3.12
	2	11.69	2.25	5.20	11.69	2.25	5.20	8.99	2.36	3.81	7.89	2.51	3.15	7.89	2.51	3.15	7.89	2.51	3.15
	5	13.37	2.58	5.18	13.37	2.58	5.18	9.90	2.76	3.58	8.91	2.87	3.10	8.91	2.87	3.10	8.91	2.87	3.10
	7	14.36	2.77	5.19	14.00	2.77	5.05	10.46	2.93	3.57	9.55	3.04	3.14						

R290 M thermal Arctic HT Series



LWT	DB	Maximum			100%(Nonimal)			75%			50%			25%			Minimum		
		HC	COP	PI	HC	COP	PI	HC	COP	PI	HC	COP	PI	HC	COP	PI	HC	COP	PI
65	-25	/	/	/	/	/	/	/	/	/	/	/	/	/	/	/	/	/	/
	-20	8.14	1.42	5.75	8.14	1.42	5.75	8.14	1.42	5.75	5.80	1.44	4.01	4.66	1.51	3.08	4.66	1.51	3.08
	-15	9.46	1.54	6.15	9.46	1.54	6.15	8.29	1.65	5.03	5.64	1.79	3.15	5.64	1.79	3.15	5.64	1.79	3.15
	-10	10.25	1.75	5.85	10.25	1.75	5.85	8.71	1.80	4.85	6.46	2.01	3.22	6.46	2.01	3.22	6.46	2.01	3.22
	-7	10.74	1.80	5.96	10.74	1.80	5.96	8.58	1.90	4.51	6.68	2.02	3.31	6.68	2.02	3.31	6.68	2.02	3.31
	-5	10.18	1.84	5.53	10.18	1.84	5.53	8.67	1.95	4.44	6.94	2.06	3.37	6.94	2.06	3.37	6.94	2.06	3.37
	-2	10.77	1.93	5.59	10.77	1.93	5.59	8.86	2.01	4.40	6.90	2.10	3.29	6.90	2.10	3.29	6.90	2.10	3.29
	0	10.70	1.98	5.40	10.70	1.98	5.40	8.85	2.05	4.32	7.22	2.16	3.34	7.22	2.16	3.34	7.22	2.16	3.34
	2	11.08	2.04	5.42	11.08	2.04	5.42	8.87	2.10	4.22	7.57	2.24	3.38	7.57	2.24	3.38	7.57	2.24	3.38
	5	13.21	2.36	5.60	13.21	2.36	5.60	9.95	2.45	4.07	8.52	2.56	3.32	8.52	2.56	3.32	8.52	2.56	3.32
	7	13.71	2.51	5.47	13.71	2.51	5.47	10.45	2.69	3.88	9.06	2.79	3.25	9.06	2.79	3.25	9.06	2.79	3.25
	10	13.94	2.69	5.19	13.94	2.69	5.19	10.50	2.85	3.69	8.74	2.92	2.99	8.74	2.92	2.99	8.74	2.92	2.99
	12	14.63	2.79	5.24	14.04	2.82	4.98	10.53	2.96	3.55	9.28	3.07	3.03	9.28	3.07	3.03	9.28	3.07	3.03
	15	13.72	2.91	4.71	13.72	2.91	4.71	10.38	3.23	3.22	9.84	3.28	3.00	9.84	3.28	3.00	9.84	3.28	3.00
	20	12.90	3.17	4.06	12.90	3.17	4.06	10.55	3.42	3.08	7.87	3.53	2.23	7.87	3.53	2.23	7.87	3.53	2.23
	25	12.85	3.44	3.74	12.85	3.44	3.74	10.47	3.71	2.82	9.14	3.78	2.42	9.14	3.78	2.42	9.14	3.78	2.42
30	12.43	3.90	3.18	12.43	3.90	3.18	10.45	4.04	2.59	9.92	4.07	2.44	9.92	4.07	2.44	9.92	4.07	2.44	
35	/	/	/	/	/	/	/	/	/	/	/	/	/	/	/	/	/	/	/
70	-25	/	/	/	/	/	/	/	/	/	/	/	/	/	/	/	/	/	/
	-20	/	/	/	/	/	/	/	/	/	/	/	/	/	/	/	/	/	/
	-15	8.93	1.54	5.79	8.93	1.54	5.79	8.22	1.56	5.27	5.47	1.65	3.32	5.47	1.65	3.32	5.47	1.65	3.32
	-10	9.87	1.68	5.87	9.87	1.68	5.87	8.72	1.74	5.02	6.50	1.92	3.40	6.50	1.92	3.40	6.50	1.92	3.40
	-7	10.07	1.75	5.74	10.07	1.75	5.74	8.60	1.82	4.73	7.04	1.96	3.59	6.90	1.96	3.52	6.90	1.96	3.52
	-5	9.75	1.77	5.52	9.75	1.77	5.52	8.68	1.84	4.71	7.13	1.97	3.61	7.13	1.97	3.61	7.13	1.97	3.61
	-2	10.33	1.80	5.74	10.33	1.80	5.74	8.83	1.87	4.72	6.98	2.00	3.49	6.98	2.00	3.49	6.98	2.00	3.49
	0	10.33	1.84	5.63	10.33	1.84	5.63	8.77	1.93	4.54	7.26	2.05	3.54	7.26	2.05	3.54	7.26	2.05	3.54
	2	10.55	1.89	5.58	10.55	1.89	5.58	8.98	2.00	4.49	7.53	2.09	3.60	7.53	2.09	3.60	7.53	2.09	3.60
	5	12.27	2.16	5.69	12.27	2.16	5.69	9.97	2.21	4.51	8.44	2.38	3.55	8.44	2.38	3.55	8.44	2.38	3.55
	7	12.71	2.24	5.67	12.71	2.24	5.67	10.55	2.40	4.39	8.72	2.52	3.45	8.72	2.52	3.45	8.72	2.52	3.45
	10	13.03	2.46	5.30	13.03	2.46	5.30	10.59	2.59	4.09	8.67	2.70	3.22	8.67	2.70	3.22	8.67	2.70	3.22
	12	13.87	2.58	5.38	13.87	2.58	5.38	10.47	2.77	3.78	9.24	2.84	3.26	9.24	2.84	3.26	9.24	2.84	3.26
	15	13.36	2.73	4.90	13.36	2.73	4.90	10.46	2.98	3.51	9.82	3.04	3.23	9.82	3.04	3.23	9.82	3.04	3.23
	20	12.74	2.89	4.41	12.74	2.89	4.41	10.56	3.04	3.47	7.87	3.28	2.40	7.87	3.28	2.40	7.87	3.28	2.40
	25	12.67	3.14	4.03	12.67	3.14	4.03	10.51	3.34	3.15	9.21	3.51	2.62	9.21	3.51	2.62	9.21	3.51	2.62
30	/	/	/	/	/	/	/	/	/	/	/	/	/	/	/	/	/	/	/
35	/	/	/	/	/	/	/	/	/	/	/	/	/	/	/	/	/	/	/
75	-25	/	/	/	/	/	/	/	/	/	/	/	/	/	/	/	/	/	/
	-20	/	/	/	/	/	/	/	/	/	/	/	/	/	/	/	/	/	/
	-15	/	/	/	/	/	/	/	/	/	/	/	/	/	/	/	/	/	/
	-10	9.33	1.46	6.41	9.33	1.46	6.41	8.35	1.57	5.32	6.26	1.74	3.61	6.26	1.74	3.61	6.26	1.74	3.61
	-7	9.48	1.60	5.93	9.48	1.60	5.93	8.42	1.67	5.03	6.84	1.80	3.80	6.84	1.80	3.80	6.84	1.80	3.80
	-5	9.04	1.65	5.48	9.04	1.65	5.48	8.66	1.69	5.12	6.99	1.83	3.82	6.99	1.83	3.82	6.99	1.83	3.82
	-2	9.55	1.66	5.74	9.55	1.66	5.74	8.76	1.72	5.10	6.92	1.85	3.73	6.92	1.85	3.73	6.92	1.85	3.73
	0	9.62	1.69	5.70	9.62	1.69	5.70	8.84	1.74	5.09	7.19	1.90	3.79	7.19	1.90	3.79	7.19	1.90	3.79
	2	9.66	1.71	5.65	9.66	1.71	5.65	9.00	1.78	5.04	7.42	1.92	3.86	7.42	1.92	3.86	7.42	1.92	3.86
	5	11.18	1.91	5.85	11.18	1.91	5.85	9.82	2.00	4.91	8.12	2.13	3.82	8.12	2.13	3.82	8.12	2.13	3.82
	7	11.40	1.97	5.79	11.40	1.97	5.79	10.56	2.03	5.20	8.26	2.14	3.85	8.26	2.14	3.85	8.26	2.14	3.85
	10	11.82	2.12	5.57	11.82	2.12	5.57	10.52	2.21	4.76	8.36	2.41	3.47	8.36	2.41	3.47	8.36	2.41	3.47
	12	12.40	2.23	5.56	12.40	2.23	5.56	10.47	2.39	4.39	8.91	2.54	3.51	8.91	2.54	3.51	8.91	2.54	3.51
	15	12.50	2.37	5.28	12.50	2.37	5.28	10.23	2.59	3.95	9.54	2.72	3.51	9.54	2.72	3.51	9.54	2.72	3.51
	20	11.12	2.64	4.21	11.12	2.64	4.21	10.34	2.73	3.79	7.64	2.90	2.64	7.64	2.90	2.64	7.64	2.90	2.64
	25	/	/	/	/	/	/	/	/	/	/	/	/	/	/	/	/	/	/
30	/	/	/	/	/	/	/	/	/	/	/	/	/	/	/	/	/	/	/
35	/	/	/	/	/	/	/	/	/	/	/	/	/	/	/	/	/	/	/

Abbreviations:

LWT: Leaving water temperature (°C)

DB: Dry-bulb temperature for Outdoor air temperature (°C)

HC: Total heating capacity (kW)

PI: Power input (kW)

16kW Heating Capacity

LWT	DB	Maximum			100%(Nonimal)			75%			50%			25%			Minimum		
		HC	COP	PI	HC	COP	PI	HC	COP	PI	HC	COP	PI	HC	COP	PI	HC	COP	PI
25	-25	9.50	1.99	4.77	9.50	1.99	4.77	9.50	1.99	4.77	6.47	2.26	2.87	2.98	2.56	1.17	2.98	2.56	1.17
	-20	11.26	2.37	4.75	11.26	2.37	4.75	9.73	2.54	3.83	6.53	2.72	2.40	3.77	3.11	1.21	3.77	3.11	1.21
	-15	12.59	2.63	4.78	12.59	2.63	4.78	9.45	3.07	3.08	6.18	3.26	1.90	4.37	3.77	1.16	4.37	3.77	1.16
	-10	13.33	2.76	4.84	12.68	2.84	4.47	9.54	3.24	2.95	6.32	3.54	1.78	4.69	3.99	1.18	4.69	3.99	1.18
	-7	13.66	2.87	4.75	12.66	3.06	4.14	9.31	3.74	2.49	6.35	4.10	1.55	5.41	4.44	1.22	5.41	4.44	1.22
	-5	14.12	3.11	4.53	12.76	3.30	3.87	9.48	3.75	2.53	6.34	4.23	1.50	5.60	4.55	1.23	5.60	4.55	1.23
	-2	14.53	3.42	4.25	12.62	3.68	3.43	9.63	4.20	2.29	6.36	4.71	1.35	4.86	5.22	0.93	4.86	5.22	0.93
	0	14.83	3.64	4.08	12.56	3.96	3.17	9.45	4.59	2.06	6.27	5.10	1.23	5.02	5.42	0.93	5.02	5.42	0.93
	2	15.03	3.84	3.91	12.65	4.24	2.98	9.46	4.93	1.92	6.45	5.41	1.19	5.38	5.80	0.93	5.38	5.80	0.93
	5	16.61	4.48	3.71	14.00	4.99	2.80	10.59	5.95	1.78	7.06	6.67	1.06	5.85	7.00	0.84	5.85	7.00	0.84
	7	18.67	5.02	3.72	14.95	5.68	2.63	11.19	6.44	1.74	7.50	7.28	1.03	6.24	7.44	0.84	6.24	7.44	0.84
	10	20.15	5.81	3.47	15.07	7.12	2.12	11.31	7.86	1.44	7.58	8.85	0.86	7.25	8.95	0.81	7.25	8.95	0.81
	12	20.80	6.32	3.29	15.03	7.78	1.93	11.26	8.70	1.29	7.71	9.79	0.79	7.71	9.79	0.79	7.71	9.79	0.79
	15	19.18	6.60	2.91	15.08	8.04	1.88	11.23	9.16	1.23	7.78	10.26	0.76	7.78	10.26	0.76	7.78	10.26	0.76
	20	16.84	7.51	2.24	15.04	8.19	1.84	11.32	9.88	1.15	7.46	11.00	0.68	6.62	11.24	0.59	6.62	11.24	0.59
	25	17.20	8.27	2.08	14.89	9.12	1.63	11.38	10.81	1.05	7.48	11.73	0.64	7.40	11.79	0.63	7.40	11.79	0.63
30	/	/	/	/	/	/	/	/	/	/	/	/	/	/	/	/	/	/	/
35	/	/	/	/	/	/	/	/	/	/	/	/	/	/	/	/	/	/	/
30	-25	9.03	1.82	4.96	9.03	1.82	4.96	9.03	1.82	4.96	6.06	1.99	3.05	2.78	2.25	1.24	2.78	2.25	1.24
	-20	10.78	2.07	5.21	10.78	2.07	5.21	9.38	2.17	4.32	6.19	2.40	2.58	3.56	2.76	1.29	3.56	2.76	1.29
	-15	12.13	2.41	5.03	12.13	2.41	5.03	9.32	2.72	3.43	6.13	2.85	2.15	4.19	3.36	1.25	4.19	3.36	1.25
	-10	12.81	2.50	5.12	12.71	2.52	5.05	9.40	2.86	3.29	6.24	3.10	2.01	4.58	3.58	1.28	4.58	3.58	1.28
	-7	13.43	2.67	5.02	12.64	2.80	4.51	9.31	3.33	2.80	6.37	3.72	1.71	5.39	4.03	1.34	5.39	4.03	1.34
	-5	13.60	2.82	4.82	12.65	2.93	4.32	9.42	3.30	2.85	6.20	3.66	1.70	5.38	4.10	1.31	5.38	4.10	1.31
	-2	14.02	3.10	4.53	12.40	3.29	3.77	9.47	3.68	2.57	6.47	3.99	1.62	4.66	4.56	1.02	4.66	4.56	1.02
	0	14.31	3.29	4.35	12.54	3.51	3.58	9.45	3.98	2.37	6.18	4.35	1.42	4.74	4.63	1.02	4.74	4.63	1.02
	2	14.50	3.47	4.18	12.64	3.72	3.40	9.50	4.26	2.23	6.21	4.61	1.35	5.16	5.02	1.03	5.16	5.02	1.03
	5	16.01	4.03	3.97	14.18	4.33	3.28	10.37	5.16	2.01	7.04	5.64	1.25	5.54	5.92	0.93	5.54	5.92	0.93
	7	17.89	4.49	3.98	15.23	4.86	3.13	11.25	5.50	2.04	7.52	6.08	1.24	5.98	6.33	0.94	5.98	6.33	0.94
	10	19.22	5.15	3.73	15.19	5.93	2.56	11.17	6.62	1.69	7.43	7.46	1.00	6.91	7.52	0.92	6.91	7.52	0.92
	12	19.84	5.59	3.55	15.03	6.65	2.26	11.20	7.29	1.54	7.72	8.01	0.96	7.32	8.10	0.90	7.32	8.10	0.90
	15	18.32	5.80	3.16	15.03	6.80	2.21	11.43	7.56	1.51	7.59	8.73	0.87	7.59	8.73	0.87	7.59	8.73	0.87
	20	16.17	6.55	2.47	15.00	7.26	2.07	11.25	8.36	1.35	7.50	9.22	0.81	6.37	9.36	0.68	6.37	9.36	0.68
	25	16.57	7.17	2.31	15.04	7.58	1.98	11.19	8.99	1.24	7.46	9.53	0.78	7.11	9.62	0.74	7.11	9.62	0.74
30	15.63	8.79	1.78	14.89	9.34	1.59	11.34	10.62	1.07	7.86	11.26	0.70	7.78	11.27	0.69	7.78	11.27	0.69	
35	/	/	/	/	/	/	/	/	/	/	/	/	/	/	/	/	/	/	/
35	-25	8.83	1.74	5.08	8.83	1.74	5.08	8.83	1.76	5.02	6.21	1.85	3.36	2.68	2.02	1.33	2.68	2.02	1.33
	-20	10.56	1.96	5.39	10.56	1.96	5.39	9.30	2.07	4.50	6.25	2.20	2.85	3.47	2.50	1.39	3.47	2.50	1.39
	-15	11.96	2.27	5.28	11.96	2.23	5.37	9.25	2.50	3.70	6.35	2.62	2.42	4.16	2.97	1.40	4.16	2.97	1.40
	-10	12.55	2.33	5.39	12.55	2.33	5.39	9.39	2.56	3.66	6.32	2.88	2.19	4.50	3.28	1.37	4.50	3.28	1.37
	-7	13.18	2.48	5.31	12.70	2.50	5.08	9.41	2.90	3.24	6.44	3.35	1.92	5.25	3.58	1.47	5.25	3.58	1.47
	-5	13.38	2.62	5.10	12.55	2.71	4.64	9.44	3.01	3.14	6.27	3.28	1.91	5.08	3.62	1.40	5.08	3.62	1.40
	-2	13.78	2.87	4.81	12.47	3.01	4.14	9.51	3.33	2.86	6.33	3.60	1.76	4.57	4.12	1.11	4.57	4.12	1.11
	0	14.05	3.03	4.64	12.80	3.17	4.03	9.64	3.56	2.71	6.30	3.87	1.63	4.73	4.33	1.09	4.73	4.33	1.09
	2	14.27	3.20	4.46	12.80	3.20	4.00	9.72	3.80	2.55	6.35	4.09	1.55	5.07	4.50	1.13	5.07	4.50	1.13
	5	15.77	3.72	4.24	14.20	3.92	3.63	10.49	4.57	2.30	7.02	4.96	1.42	5.36	5.18	1.03	5.36	5.18	1.03
	7	17.57	4.13	4.25	15.00	4.40	3.41	11.17	4.89	2.28	7.50	5.31	1.41	5.87	5.61	1.05	5.87	5.61	1.05
	10	18.31	4.58	4.00	14.94	5.04	2.97	11.24	5.51	2.04	7.49	6.09	1.23	6.42	6.22	1.03	6.42	6.22	1.03
	12	18.87	4.93	3.82	15.01	5.52	2.72	11.29	5.99	1.88	8.35	6.45	1.29	6.82	6.71	1.02	6.82	6.71	1.02
	15	17.44	5.10	3.42	15.03	5.61	2.68	11.37	6.23	1.83	7.44	6.98	1.07	7.09	7.20	0.99	7.09	7.20	0.99
	20	15.44	5.70	2.71	15.00	6.09	2.46	11.25	6.92	1.62	7.50	7.48	1.00	5.97	7.99	0.75	5.97	7.99	0.75
	25	15.82	6.18	2.56	14.97	6.45	2.32	11.11	7.48	1.49	7.51	8.30	0.90	6.68	8.47	0.79	6.68	8.47	0.79
30	14.95	7.47	2.00	14.95	7.47	2.00	11.30	8.60	1.31	7.66	8.91	0.86	7.30	9.00	0.81	7.30	9.00	0.81	
35	13.82	9.45	1.46	13.82	9.45	1.46	11.09	10.10	1.10	8.07	10.43	0.77	7.97	10.45	0.76	7.97	10.45	0.76	
40	-25	8.64	1.56	5.53	8.64	1.56	5.53	8.64	1.56	5.53	6.26	1.74	3.60	2.74	1.89	1.45	2.74	1.89	1.45
	-20	10.39	1.83	5.68	10.39	1.83	5.68	9.32	1.90	4.91	6.33	2.09	3.03	3.57	2.31	1.55	3.57	2.31	1.55
	-15	11.78	2.05	5.74	11.78	2.05	5.74	9.30	2.24	4.14	6.47	2.41	2.69	3.99	2.59	1.54	3.99	2.59	1.54
	-10	12.31	2.08	5.92	12.31	2.08	5.92	9.38	2.34	4.00	6.28	2.59	2.43	4.63	2.98	1.55	4.63	2.98	1.55
	-7	12.95	2.31	5.61	12.59	2.36	5.33	9.53	2.79	3.42	6.41	3.11	2.06	5.36	3.39	1.58	5.36	3.39	1.58
	-5	13.14	2.40	5.46	12.56	2.49	5.05	9.46	2.75	3.43	6.33	2.97	2.13	5.43	3.45	1.57	5.43	3.45	1.57
	-2	13.54	2.65	5.11	12.64	2.74	4.61	9.42	3.03	3.11	6.28	3.24	1.94	5.34	3.62	1.47	5.34	3.62	1.47
	0	13.83	2.81	4.93	12.85	2.90	4.43	9.68	3.21	3.02	6.38	3.44	1.85	5.63	3.78	1.49	5.63	3.78	1.49
	2	14.02	2.95	4.75	13.14	3.05	4.31	9.77	3.41	2.86	6.45	3.63	1.78	5.90	3.92	1.51	5.90	3.92	1.51
	5	15.49	3.42	4.53	14.20	3.55	4.00	10.58	4.10	2.58	7.19	4.28	1.68	6.70	4.38	1.53	6.70	4.38	1.53
	7	17.21	3.78	4.55	15.12	3.97	3.81	11.26	4.32	2.61	7.38	4.82	1.53	7.38	4.82	1.53	7.38	4.82	1.53
	10	17.92	4.18	4.29	14.99	4.48	3.34	11.16	4.85	2.30	7.64	5.36	1.43	7.64	5.36	1.43	7.64	5.36	1.43
	12	18.46	4.48	4.12	15.10	4.89	3.09	11.21	5.28	2.12	7.98	5.62	1.42	7.98	5.62	1.42	7.98	5.62	1.42
	15	17.11	4.63	3.69	15.11	4.95	3.05	11.31	5.49	2.06	8.44	6.08	1.39	8.44	6.08	1.39	8.44	6.08	1.39
	20	15.24	5.11	2.98	15.00	5.35	2.80	11.25	6.04	1.86	7.50	6.36	1.18	6.69	6.4				

R290 M thermal Arctic HT Series



LWT	DB	Maximum			100%(Nonimal)			75%			50%			25%			Minimum		
		HC	COP	PI	HC	COP	PI	HC	COP	PI	HC	COP	PI	HC	COP	PI	HC	COP	PI
45	-25	8.45	1.48	5.70	8.45	1.48	5.70	8.45	1.48	5.70	6.35	1.59	3.99	3.16	1.77	1.79	3.16	1.77	1.79
	-20	10.59	1.78	5.94	10.59	1.70	6.22	9.46	1.78	5.30	6.33	1.99	3.18	4.07	2.14	1.90	4.07	2.14	1.90
	-15	11.60	1.90	6.11	11.60	1.90	6.11	9.34	2.12	4.40	6.40	2.29	2.80	4.52	2.37	1.90	4.52	2.37	1.90
	-10	12.08	2.04	5.92	12.08	2.04	5.92	9.35	2.23	4.19	6.11	2.51	2.44	5.19	2.69	1.93	5.19	2.69	1.93
	-7	12.50	2.25	5.56	12.50	2.25	5.56	9.58	2.53	3.78	6.05	2.91	2.08	5.86	2.98	1.97	5.86	2.98	1.97
	-5	12.89	2.25	5.72	12.56	2.29	5.49	9.46	2.53	3.75	6.02	3.01	2.00	6.02	3.01	2.00	6.02	3.01	2.00
	-2	13.28	2.45	5.43	12.66	2.51	5.05	9.43	2.75	3.42	6.29	3.18	1.98	6.29	3.18	1.98	6.29	3.18	1.98
	0	13.57	2.59	5.24	13.17	2.63	5.01	9.71	2.92	3.33	6.68	3.31	2.02	6.68	3.31	2.02	6.68	3.31	2.02
	2	13.77	2.73	5.04	13.10	2.75	4.76	9.79	3.07	3.18	7.00	3.42	2.04	7.00	3.42	2.04	7.00	3.42	2.04
	5	15.19	3.15	4.83	14.18	3.24	4.38	10.72	3.68	2.92	7.19	3.85	1.87	7.19	3.85	1.87	7.19	3.85	1.87
	7	16.85	3.47	4.85	15.00	3.35	4.48	11.43	3.90	2.93	7.98	4.26	1.88	7.98	4.26	1.88	7.98	4.26	1.88
	10	17.50	3.81	4.60	15.01	4.02	3.73	11.24	4.35	2.59	8.30	4.67	1.78	8.30	4.67	1.78	8.30	4.67	1.78
	12	18.04	4.07	4.43	15.12	4.24	3.57	11.32	4.66	2.43	8.60	4.84	1.78	8.60	4.84	1.78	8.60	4.84	1.78
	15	16.72	4.20	3.98	15.14	4.38	3.46	11.21	4.83	2.32	9.18	5.26	1.74	9.18	5.26	1.74	9.18	5.26	1.74
	20	15.01	4.62	3.25	15.01	4.62	3.25	11.25	5.33	2.11	7.42	5.61	1.32	7.42	5.61	1.32	7.42	5.61	1.32
	25	15.36	4.99	3.08	14.96	5.07	2.95	11.17	5.75	1.94	8.34	5.96	1.40	8.34	5.96	1.40	8.34	5.96	1.40
30	14.48	5.86	2.47	14.48	5.86	2.47	11.18	6.50	1.72	9.14	6.65	1.38	9.14	6.65	1.38	9.14	6.65	1.38	
35	13.38	7.10	1.88	13.38	7.10	1.88	11.35	7.37	1.54	10.01	7.48	1.34	10.01	7.48	1.34	10.01	7.48	1.34	
50	-25	8.26	1.38	6.01	8.26	1.38	6.01	8.26	1.38	6.01	6.35	1.48	4.28	3.36	1.63	2.06	3.36	1.63	2.06
	-20	9.99	1.63	6.14	9.99	1.63	6.14	9.48	1.66	5.72	6.32	1.85	3.42	4.32	1.98	2.18	4.32	1.98	2.18
	-15	11.60	1.77	6.56	11.60	1.77	6.56	9.41	1.93	4.88	6.30	2.05	3.07	4.79	2.17	2.21	4.79	2.17	2.21
	-10	11.70	1.90	6.15	11.70	1.90	6.15	9.35	2.03	4.60	6.11	2.16	2.83	5.42	2.44	2.22	5.42	2.44	2.22
	-7	12.23	2.05	5.96	12.23	2.05	5.96	9.45	2.24	4.22	6.43	2.60	2.47	6.11	2.66	2.30	6.11	2.66	2.30
	-5	12.28	2.11	5.83	12.28	2.11	5.83	9.32	2.31	4.03	6.31	2.71	2.33	6.31	2.71	2.33	6.31	2.71	2.33
	-2	13.02	2.26	5.75	12.78	2.29	5.59	9.43	2.52	3.75	6.85	2.83	2.42	6.85	2.83	2.42	6.85	2.83	2.42
	0	13.28	2.38	5.58	13.15	2.39	5.50	9.70	2.65	3.67	7.23	2.96	2.44	7.23	2.96	2.44	7.23	2.96	2.44
	2	13.49	2.51	5.37	13.05	2.55	5.13	9.79	2.78	3.52	7.58	3.08	2.46	7.58	3.08	2.46	7.58	3.08	2.46
	5	14.87	2.89	5.14	14.13	2.95	4.79	10.74	3.31	3.25	8.38	3.57	2.35	8.38	3.57	2.35	8.38	3.57	2.35
	7	16.42	3.18	5.17	15.06	3.25	4.64	11.26	3.50	3.21	8.95	3.78	2.37	8.95	3.78	2.37	8.95	3.78	2.37
	10	17.06	3.47	4.92	15.16	3.59	4.22	11.28	3.87	2.92	8.90	4.12	2.16	8.90	4.12	2.16	8.90	4.12	2.16
	12	17.55	3.69	4.76	15.10	3.87	3.90	11.17	4.13	2.70	9.38	4.32	2.17	9.38	4.32	2.17	9.38	4.32	2.17
	15	16.29	3.80	4.29	15.14	3.92	3.87	11.28	4.24	2.66	9.85	4.59	2.14	9.85	4.59	2.14	9.85	4.59	2.14
	20	14.77	4.13	3.57	14.77	4.13	3.57	11.12	4.49	2.48	7.74	4.89	1.58	7.74	4.89	1.58	7.74	4.89	1.58
	25	15.09	4.39	3.43	14.89	4.43	3.36	11.17	4.97	2.25	8.61	5.19	1.66	8.61	5.19	1.66	8.61	5.19	1.66
30	14.19	5.20	2.73	14.19	5.20	2.73	11.19	5.69	1.97	9.57	5.84	1.64	9.57	5.84	1.64	9.57	5.84	1.64	
35	13.09	6.23	2.10	13.09	6.23	2.10	11.07	6.35	1.74	10.34	6.41	1.61	10.34	6.41	1.61	10.34	6.41	1.61	
55	-25	8.18	1.30	6.30	8.18	1.30	6.30	8.18	1.30	6.30	6.36	1.44	4.42	3.71	1.53	2.43	3.71	1.53	2.43
	-20	9.82	1.56	6.28	9.82	1.56	6.28	9.50	1.58	6.00	6.32	1.76	3.58	4.73	1.85	2.55	4.73	1.85	2.55
	-15	11.19	1.79	6.26	11.19	1.79	6.26	9.60	1.89	5.07	6.29	2.02	3.11	5.39	2.06	2.62	5.39	2.06	2.62
	-10	11.30	1.90	5.95	11.30	1.90	5.95	9.43	2.02	4.67	6.20	2.24	2.77	6.01	2.28	2.64	6.01	2.28	2.64
	-7	12.40	2.05	6.05	12.40	2.05	6.05	9.46	2.16	4.38	7.20	2.26	3.18	6.53	2.32	2.82	6.53	2.32	2.82
	-5	11.85	2.09	5.68	11.85	2.09	5.68	9.33	2.18	4.28	6.80	2.40	2.83	6.80	2.40	2.83	6.80	2.40	2.83
	-2	12.28	2.18	5.64	12.28	2.18	5.64	9.53	2.33	4.08	6.91	2.58	2.68	6.91	2.58	2.68	6.91	2.58	2.68
	0	12.91	2.26	5.70	12.91	2.26	5.70	9.81	2.45	4.01	7.28	2.69	2.71	7.28	2.69	2.71	7.28	2.69	2.71
	2	13.10	2.45	5.35	13.10	2.45	5.35	9.92	2.57	3.85	7.64	2.80	2.73	7.64	2.80	2.73	7.64	2.80	2.73
	5	14.74	2.66	5.54	14.27	2.75	5.19	10.82	3.05	3.55	9.12	3.21	2.84	9.12	3.21	2.84	9.12	3.21	2.84
	7	16.00	2.81	5.70	15.00	2.85	5.26	11.22	3.17	3.54	9.75	3.39	2.88	9.75	3.39	2.88	9.75	3.39	2.88
	10	16.89	3.14	5.38	14.99	3.34	4.49	11.19	3.52	3.18	9.05	3.70	2.44	9.05	3.70	2.44	9.05	3.70	2.44
	12	17.36	3.38	5.13	15.00	3.56	4.22	11.20	3.78	2.97	9.59	3.90	2.46	9.59	3.90	2.46	9.59	3.90	2.46
	15	16.14	3.53	4.58	14.95	3.61	4.14	11.29	3.85	2.93	10.06	4.14	2.43	10.06	4.14	2.43	10.06	4.14	2.43
	20	14.72	3.79	3.88	14.72	3.79	3.88	11.05	4.09	2.70	7.98	4.46	1.79	7.98	4.46	1.79	7.98	4.46	1.79
	25	15.00	4.14	3.63	15.00	4.14	3.63	11.31	4.62	2.45	9.12	4.77	1.91	9.12	4.77	1.91	9.12	4.77	1.91
30	14.09	4.75	2.97	14.09	4.75	2.97	11.10	5.06	2.19	9.92	5.19	1.91	9.92	5.19	1.91	9.92	5.19	1.91	
35	12.99	5.50	2.36	12.99	5.50	2.36	11.27	5.60	2.01	10.78	5.63	1.91	10.78	5.63	1.89	10.78	5.63	1.89	
60	-25	/	/	/	/	/	/	/	/	/	/	/	/	/	/	/	/	/	/
	-20	9.37	1.45	6.45	9.37	1.45	6.45	9.37	1.45	6.45	6.26	1.62	3.87	4.92	1.68	2.92	4.92	1.68	2.92
	-15	10.45	1.67	6.24	10.45	1.67	6.24	9.37	1.73	5.42	6.16	1.85	3.33	5.70	1.88	3.03	5.70	1.88	3.03
	-10	10.85	1.75	6.20	10.85	1.79	6.07	9.49	1.87	5.08	6.39	2.12	3.01	6.39	2.12	3.01	6.39	2.12	3.01
	-7	11.65	1.84	6.32	11.65	1.88	6.19	9.49	1.96	4.85	7.54	2.17	3.47	7.54	2.17	3.47	7.54	2.17	3.47
	-5	11.39	1.87	6.10	11.39	1.91	5.98	9.32	2.02	4.61	7.08	2.25	3.15	7.08	2.25	3.15	7.08	2.25	3.15
	-2	11.54	1.97	5.86	11.54	2.01	5.74	9.46	2.08	4.56	7.12	2.31	3.08	7.12	2.31	3.08	7.12	2.31	3.08
	0	11.91	2.04	5.83	11.91	2.08	5.72	9.74	2.17	4.48	7.52	2.41	3.12	7.52	2.41	3.12	7.52	2.41	3.12
	2	12.18	2.14	5.70	12.18	2.18	5.59	9.85	2.27	4.33	7.89	2.51	3.15	7.89	2.51	3.15	7.89	2.51	3.15
	5	14.19	2.49	5.70	14.19	2.49	5.70	10.75	2.67	4.03	8.91	2.87	3.10	8.91	2.87	3.10	8.91	2.87	3.10
	7	15.59	2.63	5.93	15.10	2.68	5.64	11.10	2.88	3.85	9.55	3.04	3.14	9.55	3.04	3.14	9.55	3.04	3.14
	10	16.34	2.82	5.79	15.00	2.94	5.11	11.25	3.13	3.59	9.12	3.29	2.77	9.12	3.29	2.77	9.12	3.29	2.77
	12	16.78	3.05	5.50	14.97	3.17	4.72	11.17	3.35	3.34	9.66	3.45	2.80	9.66	3.45	2.80	9.66	3.45	2.80
	15	15.61	3.14	4.97	15.04	3.20	4.69	11.26	3.43	3.29	10.19	3.68	2.77	10.19	3.68	2.77	10.19	3.68	2.77
	20	14.03	3.35	4.18	14.03	3.35	4.18	11.18	3.60</										

LWT	DB	Maximum			100%(Nonimal)			75%			50%			25%			Minimum		
		HC	COP	PI	HC	COP	PI	HC	COP	PI	HC	COP	PI	HC	COP	PI	HC	COP	PI
65	-25	/	/	/	/	/	/	/	/	/	/	/	/	/	/	/	/	/	/
	-20	8.66	1.39	6.21	8.66	1.39	6.21	8.66	1.39	6.21	6.29	1.41	4.47	4.66	1.51	3.08	4.66	1.51	3.08
	-15	9.67	1.52	6.36	9.67	1.52	6.36	9.20	1.55	5.93	6.22	1.73	3.60	5.64	1.79	3.15	5.64	1.79	3.15
	-10	10.37	1.72	6.02	10.37	1.72	6.02	9.44	1.76	5.37	6.46	2.01	3.22	6.46	2.01	3.22	6.46	2.01	3.22
	-7	10.85	1.79	6.05	10.85	1.79	6.05	9.40	1.82	5.16	6.68	2.02	3.31	6.68	2.02	3.31	6.68	2.02	3.31
	-5	10.83	1.81	5.98	10.83	1.81	5.98	9.43	1.90	4.96	6.94	2.06	3.37	6.94	2.06	3.37	6.94	2.06	3.37
	-2	10.89	1.90	5.72	10.89	1.90	5.72	9.52	1.94	4.92	6.90	2.10	3.29	6.90	2.10	3.29	6.90	2.10	3.29
	0	11.29	1.94	5.83	11.29	1.94	5.83	9.67	2.00	4.84	7.22	2.16	3.34	7.22	2.16	3.34	7.22	2.16	3.34
	2	11.32	2.01	5.63	11.32	2.01	5.63	9.85	2.08	4.74	7.57	2.24	3.38	7.57	2.24	3.38	7.57	2.24	3.38
	5	13.21	2.36	5.60	13.21	2.36	5.60	10.62	2.42	4.38	8.52	2.56	3.32	8.52	2.56	3.32	8.52	2.56	3.32
	7	14.71	2.43	6.06	14.71	2.43	6.06	11.39	2.55	4.46	9.06	2.79	3.25	9.06	2.79	3.25	9.06	2.79	3.25
	10	15.00	2.61	5.75	15.00	2.61	5.75	11.20	2.70	4.14	8.74	2.92	2.99	8.74	2.92	2.99	8.74	2.92	2.99
	12	15.35	2.72	5.65	15.17	2.74	5.53	11.26	2.90	3.88	9.28	3.07	3.03	9.28	3.07	3.03	9.28	3.07	3.03
	15	15.04	2.81	5.36	15.04	2.81	5.36	11.17	3.03	3.69	9.84	3.28	3.00	9.84	3.28	3.00	9.84	3.28	3.00
	20	13.09	3.06	4.27	13.09	3.06	4.27	11.25	3.20	3.52	7.87	3.53	2.23	7.87	3.53	2.23	7.87	3.53	2.23
25	14.27	3.31	4.32	14.27	3.31	4.32	11.13	3.63	3.07	9.14	3.78	2.42	9.14	3.78	2.42	9.14	3.78	2.42	
30	13.37	3.79	3.52	13.37	3.79	3.52	11.21	3.98	2.82	9.92	4.07	2.44	9.92	4.07	2.44	9.92	4.07	2.44	
35	/	/	/	/	/	/	/	/	/	/	/	/	/	/	/	/	/	/	
70	-25	/	/	/	/	/	/	/	/	/	/	/	/	/	/	/	/	/	/
	-20	/	/	/	/	/	/	/	/	/	/	/	/	/	/	/	/	/	/
	-15	9.17	1.53	5.99	9.17	1.53	5.99	9.17	1.53	5.99	6.35	1.61	3.93	5.47	1.65	3.32	5.47	1.65	3.32
	-10	9.99	1.67	5.98	9.99	1.67	5.98	9.96	1.69	5.88	6.50	1.92	3.40	6.50	1.92	3.40	6.50	1.92	3.40
	-7	10.61	1.73	6.14	10.61	1.73	6.14	9.57	1.78	5.38	7.04	1.96	3.59	6.90	1.96	3.52	6.90	1.96	3.52
	-5	10.38	1.75	5.92	10.38	1.75	5.92	9.59	1.79	5.36	7.13	1.97	3.61	7.13	1.97	3.61	7.13	1.97	3.61
	-2	10.45	1.79	5.84	10.45	1.79	5.84	9.64	1.84	5.23	6.98	2.00	3.49	6.98	2.00	3.49	6.98	2.00	3.49
	0	10.45	1.82	5.73	10.45	1.82	5.73	9.89	1.87	5.29	7.26	2.05	3.54	7.26	2.05	3.54	7.26	2.05	3.54
	2	10.68	1.88	5.70	10.68	1.88	5.70	10.10	1.92	5.25	7.53	2.09	3.60	7.53	2.09	3.60	7.53	2.09	3.60
	5	12.90	2.13	6.07	12.90	2.13	6.07	10.65	2.19	4.87	8.44	2.38	3.55	8.44	2.38	3.55	8.44	2.38	3.55
	7	13.59	2.19	6.22	13.59	2.19	6.22	11.16	2.32	4.81	8.72	2.52	3.45	8.72	2.52	3.45	8.72	2.52	3.45
	10	13.71	2.44	5.61	13.71	2.44	5.61	11.25	2.51	4.48	8.67	2.70	3.22	8.67	2.70	3.22	8.67	2.70	3.22
	12	13.87	2.58	5.38	13.87	2.58	5.38	11.19	2.65	4.22	9.24	2.84	3.26	9.24	2.84	3.26	9.24	2.84	3.26
	15	14.32	2.64	5.42	14.32	2.64	5.42	11.23	2.90	3.87	9.82	3.04	3.23	9.82	3.04	3.23	9.82	3.04	3.23
	20	13.14	2.86	4.60	13.14	2.86	4.60	11.36	2.91	3.90	7.87	3.28	2.40	7.87	3.28	2.40	7.87	3.28	2.40
25	13.45	3.12	4.32	13.45	3.12	4.32	11.17	3.27	3.41	9.21	3.51	2.62	9.21	3.51	2.62	9.21	3.51	2.62	
30	/	/	/	/	/	/	/	/	/	/	/	/	/	/	/	/	/	/	/
35	/	/	/	/	/	/	/	/	/	/	/	/	/	/	/	/	/	/	/
75	-25	/	/	/	/	/	/	/	/	/	/	/	/	/	/	/	/	/	/
	-20	/	/	/	/	/	/	/	/	/	/	/	/	/	/	/	/	/	/
	-15	/	/	/	/	/	/	/	/	/	/	/	/	/	/	/	/	/	/
	-10	9.69	1.43	6.79	9.69	1.43	6.79	9.55	1.45	6.59	6.26	1.74	3.61	6.26	1.74	3.61	6.26	1.74	3.61
	-7	10.06	1.57	6.42	10.06	1.57	6.42	9.48	1.60	5.93	6.84	1.80	3.80	6.84	1.80	3.80	6.84	1.80	3.80
	-5	9.71	1.63	5.94	9.71	1.63	5.94	9.46	1.63	5.80	6.99	1.83	3.82	6.99	1.83	3.82	6.99	1.83	3.82
	-2	9.71	1.65	5.89	9.71	1.65	5.89	9.58	1.65	5.81	6.92	1.85	3.73	6.92	1.85	3.73	6.92	1.85	3.73
	0	9.68	1.67	5.79	9.68	1.67	5.79	9.68	1.67	5.79	7.19	1.90	3.79	7.19	1.90	3.79	7.19	1.90	3.79
	2	9.72	1.69	5.74	9.72	1.69	5.74	9.72	1.70	5.70	7.42	1.92	3.86	7.42	1.92	3.86	7.42	1.92	3.86
	5	11.59	1.89	6.15	11.59	1.89	6.15	10.56	1.92	5.50	8.12	2.13	3.82	8.12	2.13	3.82	8.12	2.13	3.82
	7	12.36	1.92	6.43	12.36	1.92	6.43	11.16	1.94	5.75	8.26	2.14	3.85	8.26	2.14	3.85	8.26	2.14	3.85
	10	11.91	2.10	5.68	11.91	2.10	5.68	11.16	2.17	5.15	8.36	2.41	3.47	8.36	2.41	3.47	8.36	2.41	3.47
	12	12.40	2.23	5.56	12.40	2.23	5.56	11.11	2.32	4.78	8.91	2.54	3.51	8.91	2.54	3.51	8.91	2.54	3.51
	15	12.88	2.31	5.57	12.88	2.31	5.57	11.15	2.50	4.46	9.54	2.72	3.51	9.54	2.72	3.51	9.54	2.72	3.51
	20	11.12	2.64	4.21	11.12	2.64	4.21	11.12	2.64	4.21	7.64	2.90	2.64	7.64	2.90	2.64	7.64	2.90	2.64
25	/	/	/	/	/	/	/	/	/	/	/	/	/	/	/	/	/	/	/
30	/	/	/	/	/	/	/	/	/	/	/	/	/	/	/	/	/	/	/
35	/	/	/	/	/	/	/	/	/	/	/	/	/	/	/	/	/	/	/

Abbreviations:

LWT: Leaving water temperature (°C)

DB: Dry-bulb temperature for Outdoor air temperature (°C)

HC: Total heating capacity (kW)

PI: Power input (kW)

6.2 Cooling Capacity Tables (Test standard: EN14511)

4kW Cooling Capacity

LWT	DB	Maximum			100%(Nonimal)			75%			50%			25%			Minimum		
		CC	EER	PI	CC	EER	PI	CC	EER	PI	CC	EER	PI	CC	EER	PI	CC	EER	PI
5	-5	/	/	/	/	/	/	/	/	/	/	/	/	/	/	/	/	/	/
	0	/	/	/	/	/	/	/	/	/	/	/	/	/	/	/	/	/	/
	5	/	/	/	/	/	/	/	/	/	/	/	/	/	/	/	/	/	/
	10	/	/	/	/	/	/	/	/	/	/	/	/	/	/	/	/	/	/
	15	/	/	/	/	/	/	/	/	/	/	/	/	/	/	/	/	/	/
	19	4.48	5.70	0.79	4.48	5.70	0.79	3.49	6.09	0.57	2.53	6.25	0.40	2.53	6.25	0.40	2.53	6.25	0.40
	20	4.53	5.50	0.82	4.53	5.50	0.82	3.53	5.90	0.60	2.60	6.15	0.42	2.50	6.20	0.40	2.50	6.20	0.40
	25	4.96	4.59	1.08	4.69	4.68	1.00	3.55	5.02	0.71	2.45	5.29	0.46	2.38	5.32	0.45	2.38	5.32	0.45
	30	5.23	3.92	1.33	4.68	4.09	1.15	3.49	4.38	0.80	2.31	4.52	0.51	2.24	4.55	0.49	2.24	4.55	0.49
	35	5.31	3.38	1.57	4.68	3.52	1.33	3.54	3.70	0.96	2.35	3.85	0.61	2.14	3.88	0.55	2.14	3.88	0.55
	40	4.99	2.96	1.69	4.70	3.02	1.56	3.50	3.26	1.07	2.35	3.38	0.70	1.99	3.45	0.58	1.99	3.45	0.58
43	4.80	2.71	1.77	4.66	2.75	1.69	3.52	2.98	1.18	2.34	3.23	0.72	1.92	3.31	0.58	1.92	3.31	0.58	
46	4.49	2.55	1.76	4.49	2.55	1.76	3.37	2.68	1.26	2.24	2.85	0.79	1.88	2.93	0.64	1.88	2.93	0.64	
7	-5	/	/	/	/	/	/	/	/	/	/	/	/	/	/	/	/	/	
	0	/	/	/	/	/	/	/	/	/	/	/	/	/	/	/	/	/	
	5	/	/	/	/	/	/	/	/	/	/	/	/	/	/	/	/	/	
	10	/	/	/	/	/	/	/	/	/	/	/	/	/	/	/	/	/	
	15	/	/	/	/	/	/	/	/	/	/	/	/	/	/	/	/	/	
	19	4.76	6.06	0.78	4.68	6.12	0.77	3.53	6.60	0.53	2.70	6.72	0.40	2.70	6.72	0.40	2.70	6.72	0.40
	20	4.81	5.84	0.82	4.74	5.90	0.80	3.49	6.38	0.55	2.75	6.59	0.42	2.67	6.60	0.41	2.67	6.60	0.41
	25	5.28	4.85	1.09	4.72	5.06	0.93	3.51	5.39	0.65	2.62	5.72	0.46	2.54	5.73	0.44	2.54	5.73	0.44
	30	5.57	4.13	1.35	4.73	4.40	1.07	3.55	4.68	0.76	2.48	4.86	0.51	2.41	4.87	0.49	2.41	4.87	0.49
	35	5.66	3.54	1.60	4.70	3.65	1.29	3.53	3.99	0.89	2.33	4.35	0.54	2.29	4.38	0.52	2.29	4.38	0.52
	40	5.33	3.10	1.72	4.71	3.24	1.45	3.50	3.49	1.00	2.36	3.65	0.65	2.15	3.67	0.59	2.15	3.67	0.59
43	5.13	2.83	1.81	4.68	2.95	1.59	3.53	3.15	1.12	2.35	3.29	0.71	2.06	3.31	0.62	2.06	3.31	0.62	
46	4.79	2.67	1.80	4.79	2.67	1.80	3.47	2.91	1.19	2.33	3.01	0.78	2.03	3.03	0.67	2.03	3.03	0.67	
10	-5	/	/	/	/	/	/	/	/	/	/	/	/	/	/	/	/	/	
	0	/	/	/	/	/	/	/	/	/	/	/	/	/	/	/	/	/	
	5	/	/	/	/	/	/	/	/	/	/	/	/	/	/	/	/	/	
	10	/	/	/	/	/	/	/	/	/	/	/	/	/	/	/	/	/	
	15	4.75	7.31	0.65	4.63	7.58	0.61	3.52	7.91	0.44	3.08	8.04	0.38	3.08	8.04	0.38	3.08	8.04	0.38
	19	5.23	6.53	0.80	4.61	6.69	0.69	3.44	6.98	0.49	3.07	7.31	0.42	2.99	7.34	0.41	2.99	7.34	0.41
	20	5.30	6.33	0.84	4.59	6.40	0.72	3.52	6.72	0.52	3.04	7.08	0.43	2.95	7.10	0.42	2.95	7.10	0.42
	25	5.81	5.21	1.12	4.58	5.44	0.84	3.45	5.79	0.59	2.89	6.16	0.47	2.81	6.17	0.46	2.81	6.17	0.46
	30	6.13	4.46	1.37	4.62	4.70	0.98	3.51	5.10	0.69	2.75	5.38	0.51	2.67	5.39	0.50	2.67	5.39	0.50
	35	6.22	3.80	1.64	4.59	4.13	1.11	3.51	4.33	0.81	2.59	4.53	0.57	2.51	4.55	0.55	2.51	4.55	0.55
	40	5.86	3.32	1.77	4.59	3.57	1.28	3.50	3.79	0.92	2.43	4.03	0.60	2.39	4.05	0.59	2.39	4.05	0.59
43	5.63	3.05	1.85	4.67	3.28	1.42	3.46	3.51	0.99	2.34	3.67	0.64	2.30	3.68	0.62	2.30	3.68	0.62	
46	5.27	2.88	1.83	4.65	3.00	1.55	3.51	3.20	1.10	2.34	3.35	0.70	2.25	3.37	0.67	2.25	3.37	0.67	
11	-5	/	/	/	/	/	/	/	/	/	/	/	/	/	/	/	/	/	
	0	/	/	/	/	/	/	/	/	/	/	/	/	/	/	/	/	/	
	5	/	/	/	/	/	/	/	/	/	/	/	/	/	/	/	/	/	
	10	4.40	8.40	0.52	4.37	8.50	0.51	4.01	8.80	0.46	4.01	8.80	0.46	4.01	8.80	0.46	4.01	8.80	0.46
	15	4.89	7.51	0.65	4.58	7.68	0.60	3.52	8.00	0.44	3.17	8.18	0.39	3.17	8.18	0.39	3.17	8.18	0.39
	19	5.40	6.78	0.80	4.56	7.22	0.63	3.44	7.54	0.46	3.17	7.74	0.41	3.09	7.76	0.40	3.09	7.76	0.40
	20	5.46	6.42	0.85	4.62	6.89	0.67	3.52	7.24	0.49	3.14	7.34	0.43	3.05	7.35	0.42	3.05	7.35	0.42
	25	5.99	5.42	1.11	4.61	5.78	0.80	3.45	6.20	0.56	2.99	6.23	0.48	2.90	6.29	0.46	2.90	6.29	0.46
	30	6.32	4.57	1.38	4.66	4.92	0.95	3.52	5.25	0.67	2.84	5.56	0.51	2.76	5.59	0.49	2.76	5.59	0.49
	35	6.41	3.89	1.65	4.64	4.31	1.08	3.43	4.65	0.74	2.67	4.78	0.56	2.60	4.79	0.54	2.60	4.79	0.54
	40	6.04	3.39	1.78	4.56	3.80	1.20	3.43	4.03	0.85	2.52	4.17	0.60	2.47	4.20	0.59	2.47	4.20	0.59
43	5.82	3.12	1.86	4.65	3.41	1.36	3.50	3.64	0.96	2.42	3.80	0.64	2.37	3.82	0.62	2.37	3.82	0.62	
46	5.44	2.92	1.86	4.63	3.11	1.49	3.45	3.31	1.04	2.33	3.45	0.68	2.33	3.45	0.68	2.33	3.45	0.68	
15	-5	5.34	11.68	0.46	5.34	11.68	0.46	5.11	11.85	0.43	5.11	11.85	0.43	5.11	11.85	0.43	5.11	11.85	0.43
	0	5.27	11.35	0.46	5.27	11.35	0.46	4.70	11.60	0.41	4.70	11.60	0.41	4.70	11.60	0.41	4.70	11.60	0.41
	5	5.36	10.88	0.49	5.36	10.88	0.49	4.60	11.03	0.42	4.60	11.03	0.42	4.60	11.03	0.42	4.60	11.03	0.42
	10	5.16	10.44	0.49	5.16	10.44	0.49	4.46	10.66	0.42	4.46	10.66	0.42	4.46	10.66	0.42	4.46	10.66	0.42
	15	5.39	9.21	0.59	4.60	9.34	0.49	3.62	9.69	0.37	3.50	9.71	0.36	3.50	9.71	0.36	3.50	9.71	0.36
	19	5.96	8.12	0.73	4.53	8.29	0.55	3.55	8.66	0.41	3.42	8.68	0.39	3.42	8.68	0.39	3.42	8.68	0.39
	20	6.03	7.42	0.81	4.49	7.61	0.59	3.51	7.94	0.44	3.37	7.96	0.42	3.37	7.96	0.42	3.37	7.96	0.42
	25	6.75	6.01	1.12	4.50	6.60	0.68	3.45	6.96	0.50	3.28	7.09	0.46	3.28	7.09	0.46	3.28	7.09	0.46
	30	7.13	5.04	1.41	4.56	5.78	0.79	3.41	6.20	0.55	3.11	6.29	0.49	3.05	6.31	0.48	3.05	6.31	0.48
	35	7.18	4.24	1.70	4.57	4.93	0.93	3.43	5.29	0.65	3.04	5.47	0.56	2.98	5.50	0.54	2.98	5.50	0.54
	40	6.79	3.69	1.84	4.54	4.27	1.06	3.47	4.60	0.76	2.87	4.64	0.62	2.80	4.65	0.60	2.80	4.65	0.60
43	6.51	3.33	1.96	4.58	3.90	1.17	3.47	4.18	0.83	2.77	4.21	0.66	2.71	4.22	0.64	2.71	4.22	0.64	
46	6.14	3.18	1.93	4.62	3.58	1.29	3.45	3.79	0.91	2.68	3.83	0.70	2.68	3.83	0.70	2.68	3.83	0.70	

LWT	DB	Maximum			100%(Nominal)			75%			50%			25%			Minimum		
		CC	EER	PI	CC	EER	PI	CC	EER	PI	CC	EER	PI	CC	EER	PI	CC	EER	PI
18	-5	5.85	12.71	0.46	5.85	12.71	0.46	5.35	13.01	0.41	5.35	13.01	0.41	5.35	13.01	0.41	5.35	13.01	0.41
	0	5.75	12.26	0.47	5.75	12.26	0.47	5.45	12.56	0.43	5.45	12.56	0.43	5.45	12.56	0.43	5.45	12.56	0.43
	5	5.80	10.92	0.53	5.80	10.92	0.53	5.60	11.02	0.51	5.60	11.02	0.51	5.60	11.02	0.51	5.60	11.02	0.51
	10	5.66	10.31	0.55	4.98	10.81	0.46	4.81	10.84	0.44	4.81	10.84	0.44	4.81	10.84	0.44	4.81	10.84	0.44
	15	5.91	9.85	0.60	4.50	10.21	0.44	3.90	10.63	0.37	3.82	10.66	0.36	3.82	10.66	0.36	3.82	10.66	0.36
	19	6.51	8.54	0.76	4.43	9.25	0.48	3.82	9.61	0.40	3.74	9.64	0.39	3.74	9.64	0.39	3.74	9.64	0.39
	20	6.59	8.00	0.82	4.52	8.67	0.52	3.80	9.17	0.41	3.70	9.19	0.40	3.70	9.19	0.40	3.70	9.19	0.40
	25	7.18	6.49	1.11	4.42	7.28	0.61	3.59	7.99	0.45	3.52	8.04	0.44	3.52	8.04	0.44	3.52	8.04	0.44
	30	7.78	5.42	1.44	4.50	6.32	0.71	3.43	6.82	0.50	3.34	6.82	0.49	3.34	6.82	0.49	3.34	6.82	0.49
	35	7.84	4.52	1.73	4.50	5.50	0.82	3.42	5.98	0.57	3.25	6.01	0.54	3.18	6.02	0.53	3.18	6.02	0.53
	40	7.41	3.92	1.89	4.52	4.76	0.95	3.34	5.15	0.65	3.16	5.23	0.60	3.09	5.24	0.59	3.09	5.24	0.59
	43	7.13	3.60	1.98	4.48	4.39	1.02	3.34	4.66	0.72	3.05	4.70	0.65	2.98	4.71	0.63	2.98	4.71	0.63
46	6.70	3.38	1.98	4.55	3.98	1.14	3.34	4.21	0.79	2.95	4.25	0.70	2.95	4.25	0.70	2.95	4.25	0.70	
20	-5	6.32	13.35	0.47	6.32	13.35	0.47	5.94	13.56	0.44	5.94	13.56	0.44	5.94	13.56	0.44	5.94	13.56	0.44
	0	6.25	12.93	0.48	6.25	12.93	0.48	5.75	13.03	0.44	5.75	13.03	0.44	5.75	13.03	0.44	5.75	13.03	0.44
	5	5.99	12.04	0.50	5.99	12.27	0.49	5.69	12.40	0.46	5.69	12.40	0.46	5.69	12.40	0.46	5.69	12.40	0.46
	10	5.89	11.65	0.51	5.19	12.03	0.43	5.19	12.03	0.43	5.19	12.03	0.43	5.19	12.03	0.43	5.19	12.03	0.43
	15	6.26	10.97	0.57	4.48	11.50	0.39	4.13	11.53	0.36	4.04	11.56	0.35	4.04	11.56	0.35	4.04	11.56	0.35
	19	6.91	9.96	0.69	4.55	10.48	0.43	4.05	10.70	0.38	3.97	10.74	0.37	3.97	10.74	0.37	3.97	10.74	0.37
	20	6.99	8.89	0.79	4.51	9.57	0.47	4.02	9.97	0.40	3.93	10.06	0.39	3.93	10.06	0.39	3.93	10.06	0.39
	25	7.62	7.20	1.06	4.56	8.39	0.54	3.81	8.69	0.44	3.74	8.73	0.43	3.74	8.73	0.43	3.74	8.73	0.43
	30	8.24	5.94	1.39	4.52	7.10	0.64	3.64	7.42	0.49	3.57	7.45	0.48	3.57	7.45	0.48	3.57	7.45	0.48
	35	8.30	4.71	1.76	4.54	5.87	0.77	3.44	6.29	0.55	3.39	6.32	0.54	3.39	6.32	0.54	3.39	6.32	0.54
	40	7.83	4.08	1.92	4.44	5.04	0.88	3.36	5.46	0.62	3.29	5.51	0.60	3.29	5.51	0.60	3.29	5.51	0.60
	43	7.55	3.60	2.10	4.54	4.58	0.99	3.31	4.97	0.67	3.18	5.02	0.63	3.18	5.02	0.63	3.18	5.02	0.63
46	7.10	3.42	2.08	4.50	4.27	1.05	3.32	4.52	0.73	3.15	4.57	0.69	3.15	4.57	0.69	3.15	4.57	0.69	
25	-5	7.58	13.63	0.56	7.58	13.63	0.56	6.88	13.87	0.50	6.88	13.87	0.50	6.88	13.87	0.50	6.88	13.87	0.50
	0	7.26	13.31	0.55	7.26	13.31	0.55	6.66	13.40	0.50	6.66	13.40	0.50	6.66	13.40	0.50	6.66	13.40	0.50
	5	6.95	12.52	0.55	6.95	12.52	0.55	6.45	12.72	0.51	6.45	12.72	0.51	6.45	12.72	0.51	6.45	12.72	0.51
	10	6.35	11.88	0.53	5.96	12.10	0.49	5.83	12.15	0.48	5.83	12.15	0.48	5.83	12.15	0.48	5.83	12.15	0.48
	15	7.17	10.72	0.67	4.76	11.41	0.42	4.76	11.47	0.41	4.67	11.53	0.40	4.67	11.53	0.40	4.67	11.53	0.40
	19	7.96	9.51	0.84	4.69	10.48	0.45	4.69	10.42	0.45	4.59	10.52	0.44	4.59	10.52	0.44	4.59	10.52	0.44
	20	8.05	8.73	0.92	4.66	10.03	0.46	4.66	9.98	0.47	4.55	10.03	0.45	4.55	10.03	0.45	4.55	10.03	0.45
	25	8.75	7.65	1.14	4.42	8.84	0.50	4.42	8.91	0.50	4.34	9.03	0.48	4.34	9.03	0.48	4.34	9.03	0.48
	30	9.22	7.12	1.29	4.46	8.18	0.55	4.23	8.38	0.50	4.13	8.39	0.49	4.13	8.39	0.49	4.13	8.39	0.49
	35	9.62	5.56	1.73	4.53	6.96	0.65	4.01	7.25	0.55	3.94	7.30	0.54	3.94	7.30	0.54	3.94	7.30	0.54
	40	9.11	4.85	1.88	4.45	6.04	0.74	3.82	6.30	0.61	3.73	6.33	0.59	3.73	6.33	0.59	3.73	6.33	0.59
	43	8.65	4.05	2.14	4.56	5.46	0.84	3.69	5.67	0.65	3.61	5.71	0.63	3.61	5.71	0.63	3.61	5.71	0.63
46	8.22	3.86	2.13	4.57	5.08	0.90	3.66	5.22	0.70	3.66	5.22	0.70	3.66	5.22	0.70	3.66	5.22	0.70	

Abbreviations:

LWT: Leaving water temperature (°C)

DB: Dry-bulb temperature for Outdoor air temperature (°C)

CC: Total cooling capacity (kW)

PI: Power input (kW)

R290 M thermal Arctic HT Series



6kW Cooling Capacity

LWT	DB	Maximum			100%(Nonimal)			75%			50%			25%			Minimum		
		CC	EER	PI	CC	EER	PI	CC	EER	PI	CC	EER	PI	CC	EER	PI	CC	EER	PI
5	-5	/	/	/	/	/	/	/	/	/	/	/	/	/	/	/	/	/	/
	0	/	/	/	/	/	/	/	/	/	/	/	/	/	/	/	/	/	/
	5	/	/	/	/	/	/	/	/	/	/	/	/	/	/	/	/	/	/
	10	/	/	/	/	/	/	/	/	/	/	/	/	/	/	/	/	/	/
	15	/	/	/	/	/	/	/	/	/	/	/	/	/	/	/	/	/	/
	19	5.40	5.30	1.02	5.40	5.30	1.02	4.05	5.71	0.71	2.70	6.22	0.43	2.53	6.25	0.40	2.53	6.25	0.40
	20	5.54	5.12	1.08	5.54	5.12	1.08	4.15	5.53	0.75	2.77	6.10	0.45	2.50	6.20	0.40	2.50	6.20	0.40
	25	6.10	4.22	1.45	6.10	4.22	1.45	4.57	4.69	0.98	3.05	5.15	0.59	2.38	5.32	0.45	2.38	5.32	0.45
	30	6.75	3.48	1.94	6.75	3.48	1.94	5.09	3.83	1.33	3.40	4.39	0.77	2.24	4.55	0.49	2.24	4.55	0.49
	35	6.77	2.94	2.30	6.77	2.94	2.30	5.04	3.30	1.53	3.40	3.68	0.92	2.14	3.88	0.55	2.14	3.88	0.55
	40	5.44	2.80	1.95	5.44	2.80	1.95	4.08	3.06	1.33	2.72	3.32	0.82	1.99	3.45	0.58	1.99	3.45	0.58
	43	4.86	2.70	1.80	4.86	2.70	1.80	3.64	2.90	1.25	2.43	3.20	0.76	1.92	3.31	0.58	1.92	3.31	0.58
46	4.49	2.55	1.76	4.49	2.55	1.76	3.37	2.68	1.26	2.24	2.85	0.79	1.88	2.93	0.64	1.88	2.93	0.64	
7	-5	/	/	/	/	/	/	/	/	/	/	/	/	/	/	/	/	/	
	0	/	/	/	/	/	/	/	/	/	/	/	/	/	/	/	/	/	
	5	/	/	/	/	/	/	/	/	/	/	/	/	/	/	/	/	/	
	10	/	/	/	/	/	/	/	/	/	/	/	/	/	/	/	/	/	
	15	/	/	/	/	/	/	/	/	/	/	/	/	/	/	/	/	/	
	19	5.76	5.68	1.01	5.76	5.68	1.01	4.32	6.13	0.70	2.88	6.65	0.43	2.70	6.72	0.40	2.70	6.72	0.40
	20	5.90	5.47	1.08	5.90	5.47	1.08	4.43	5.91	0.75	2.95	6.41	0.46	2.67	6.60	0.41	2.67	6.60	0.41
	25	6.50	4.52	1.44	6.50	4.52	1.44	4.88	4.93	0.99	3.25	5.42	0.60	2.54	5.73	0.44	2.54	5.73	0.44
	30	7.11	3.69	1.93	6.75	3.77	1.79	5.09	4.14	1.23	3.37	4.69	0.72	2.41	4.87	0.49	2.41	4.87	0.49
	35	7.14	3.01	2.38	6.80	3.10	2.19	5.05	3.55	1.42	3.38	4.01	0.84	2.29	4.38	0.52	2.29	4.38	0.52
	40	5.82	2.94	1.98	5.82	2.94	1.98	4.36	3.26	1.34	2.91	3.61	0.81	2.15	3.67	0.59	2.15	3.67	0.59
	43	5.19	2.82	1.84	5.19	2.82	1.84	3.89	3.07	1.27	2.59	3.27	0.79	2.06	3.31	0.62	2.06	3.31	0.62
46	4.79	2.67	1.80	4.79	2.67	1.80	3.59	2.89	1.24	2.33	3.01	0.78	2.03	3.03	0.67	2.03	3.03	0.67	
10	-5	/	/	/	/	/	/	/	/	/	/	/	/	/	/	/	/	/	
	0	/	/	/	/	/	/	/	/	/	/	/	/	/	/	/	/	/	
	5	/	/	/	/	/	/	/	/	/	/	/	/	/	/	/	/	/	
	10	/	/	/	/	/	/	/	/	/	/	/	/	/	/	/	/	/	
	15	5.72	7.05	0.81	5.72	7.05	0.81	4.33	7.60	0.57	3.08	8.04	0.38	3.08	8.04	0.38	3.08	8.04	0.38
	19	6.31	6.17	1.02	6.31	6.17	1.02	4.73	6.65	0.71	3.20	7.30	0.44	2.99	7.34	0.41	2.99	7.34	0.41
	20	6.47	5.94	1.09	6.47	5.94	1.09	4.89	6.37	0.77	3.26	7.05	0.46	2.95	7.10	0.42	2.95	7.10	0.42
	25	7.16	4.80	1.49	6.64	4.90	1.36	4.96	5.42	0.92	3.40	5.99	0.57	2.81	6.17	0.46	2.81	6.17	0.46
	30	7.80	3.96	1.97	6.75	4.17	1.62	5.04	4.67	1.08	3.36	5.23	0.64	2.67	5.39	0.50	2.67	5.39	0.50
	35	7.80	3.27	2.39	6.65	3.58	1.86	5.05	3.97	1.27	3.37	4.35	0.77	2.51	4.55	0.55	2.51	4.55	0.55
	40	6.40	3.17	2.02	6.40	3.17	2.02	4.80	3.48	1.38	3.20	3.81	0.84	2.39	4.05	0.59	2.39	4.05	0.59
	43	5.70	3.01	1.89	5.70	3.01	1.89	4.26	3.32	1.28	2.81	3.55	0.79	2.30	3.68	0.62	2.30	3.68	0.62
46	5.27	2.88	1.83	5.27	2.88	1.83	3.96	3.15	1.25	2.64	3.22	0.82	2.25	3.37	0.67	2.25	3.37	0.67	
11	-5	/	/	/	/	/	/	/	/	/	/	/	/	/	/	/	/	/	
	0	/	/	/	/	/	/	/	/	/	/	/	/	/	/	/	/	/	
	5	/	/	/	/	/	/	/	/	/	/	/	/	/	/	/	/	/	
	10	4.94	8.30	0.59	4.94	8.30	0.59	4.01	8.80	0.46	4.01	8.80	0.46	4.01	8.80	0.46	4.01	8.80	0.46
	15	5.89	7.19	0.82	5.89	7.19	0.82	4.42	7.73	0.57	3.17	8.18	0.39	3.17	8.18	0.39	3.17	8.18	0.39
	19	6.50	6.30	1.03	6.50	6.60	0.98	4.87	7.14	0.68	3.30	7.71	0.43	3.09	7.76	0.40	3.09	7.76	0.40
	20	6.68	5.93	1.13	6.68	6.23	1.07	5.05	6.73	0.75	3.38	7.27	0.46	3.05	7.35	0.42	3.05	7.35	0.42
	25	7.39	4.87	1.52	6.65	5.26	1.26	5.02	5.65	0.89	3.31	6.23	0.53	2.90	6.29	0.46	2.90	6.29	0.46
	30	7.98	4.01	1.99	6.64	4.31	1.54	5.01	4.87	1.03	3.37	5.44	0.62	2.76	5.59	0.49	2.76	5.59	0.49
	35	8.04	3.30	2.44	6.67	3.71	1.80	5.06	4.15	1.22	3.39	4.70	0.72	2.60	4.79	0.54	2.60	4.79	0.54
	40	6.61	3.21	2.06	6.61	3.21	2.06	4.95	3.60	1.37	3.30	4.05	0.82	2.47	4.20	0.59	2.47	4.20	0.59
	43	5.88	3.05	1.93	5.88	3.05	1.93	4.41	3.45	1.28	2.94	3.70	0.79	2.37	3.82	0.62	2.37	3.82	0.62
46	5.44	2.92	1.86	5.44	2.92	1.86	4.08	3.27	1.25	2.72	3.41	0.80	2.33	3.45	0.68	2.33	3.45	0.68	
15	-5	5.89	11.26	0.52	5.89	11.26	0.52	5.11	11.85	0.43	5.11	11.85	0.43	5.11	11.85	0.43	5.11	11.85	0.43
	0	5.78	11.00	0.53	5.78	11.00	0.53	5.00	11.56	0.43	4.70	11.60	0.41	4.70	11.60	0.41	4.70	11.60	0.41
	5	5.54	10.52	0.53	5.54	10.52	0.53	4.80	11.00	0.44	4.60	11.03	0.42	4.60	11.03	0.42	4.60	11.03	0.42
	10	5.40	10.18	0.53	5.40	10.18	0.53	4.46	10.66	0.42	4.46	10.66	0.42	4.46	10.66	0.42	4.46	10.66	0.42
	15	6.45	8.91	0.72	6.45	8.91	0.72	4.84	9.21	0.53	3.50	9.71	0.36	3.50	9.71	0.36	3.50	9.71	0.36
	19	7.13	7.66	0.93	6.55	7.73	0.85	4.89	8.17	0.60	3.42	8.68	0.39	3.42	8.68	0.39	3.42	8.68	0.39
	20	7.32	7.00	1.05	6.49	7.28	0.89	4.96	7.52	0.66	3.37	7.96	0.42	3.37	7.96	0.42	3.37	7.96	0.42
	25	8.30	5.47	1.52	6.50	6.03	1.08	4.86	6.57	0.74	3.28	7.09	0.46	3.28	7.09	0.46	3.28	7.09	0.46
	30	8.99	4.51	1.99	6.57	5.12	1.28	4.91	5.74	0.85	3.27	6.28	0.52	3.05	6.31	0.48	3.05	6.31	0.48
	35	8.99	3.70	2.43	6.52	4.42	1.48	4.92	4.91	1.00	3.31	5.40	0.61	2.98	5.50	0.54	2.98	5.50	0.54
	40	7.42	3.44	2.16	6.58	3.70	1.78	4.95	4.16	1.19	3.33	4.61	0.72	2.80	4.65	0.60	2.80	4.65	0.60
	43	6.60	3.30	2.00	6.51	3.33	1.96	4.88	3.79	1.29	3.31	4.18	0.79	2.71	4.22	0.64	2.71	4.22	0.64
46	6.14	3.18	1.93	6.14	3.18	1.93	4.60	3.60	1.28	3.07	3.81	0.81	2.68	3.83	0.70	2.68	3.83	0.70	

LWT	DB	Maximum			100%(Nonimal)			75%			50%			25%			Minimum		
		CC	EER	PI	CC	EER	PI	CC	EER	PI	CC	EER	PI	CC	EER	PI	CC	EER	PI
18	-5	6.37	12.58	0.51	6.37	12.58	0.51	5.53	12.90	0.43	5.35	13.01	0.41	5.35	13.01	0.41	5.35	13.01	0.41
	0	6.28	12.03	0.52	6.28	12.03	0.52	5.45	12.56	0.43	5.45	12.56	0.43	5.45	12.56	0.43	5.45	12.56	0.43
	5	6.02	10.76	0.56	6.02	10.76	0.56	5.60	11.02	0.51	5.60	11.02	0.51	5.60	11.02	0.51	5.60	11.02	0.51
	10	5.89	10.22	0.58	5.89	10.22	0.58	4.81	10.84	0.44	4.81	10.84	0.44	4.81	10.84	0.44	4.81	10.84	0.44
	15	7.04	9.31	0.76	6.65	9.71	0.68	4.90	10.08	0.49	3.82	10.66	0.36	3.82	10.66	0.36	3.82	10.66	0.36
	19	7.79	8.22	0.95	6.52	8.53	0.76	4.86	9.14	0.53	3.74	9.64	0.39	3.74	9.64	0.39	3.74	9.64	0.39
	20	7.98	7.70	1.04	6.47	8.22	0.79	4.81	8.65	0.56	3.70	9.19	0.40	3.70	9.19	0.40	3.70	9.19	0.40
	25	9.03	6.06	1.49	6.44	6.89	0.93	4.82	7.32	0.66	3.52	8.04	0.44	3.52	8.04	0.44	3.52	8.04	0.44
	30	9.77	4.86	2.01	6.49	5.75	1.13	4.88	6.32	0.77	3.34	6.82	0.49	3.34	6.82	0.49	3.34	6.82	0.49
	35	9.75	4.10	2.38	6.50	5.10	1.27	4.91	5.48	0.90	3.29	6.00	0.55	3.18	6.02	0.53	3.18	6.02	0.53
	40	8.07	3.70	2.18	6.45	4.33	1.49	4.88	4.64	1.05	3.21	5.16	0.62	3.09	5.24	0.59	3.09	5.24	0.59
43	7.20	3.50	2.06	6.43	3.97	1.62	4.83	4.22	1.14	3.21	4.68	0.68	2.98	4.71	0.63	2.98	4.71	0.63	
46	6.70	3.38	1.98	6.50	3.47	1.87	4.88	3.91	1.25	3.25	4.22	0.77	2.95	4.25	0.70	2.95	4.25	0.70	
20	-5	6.71	13.26	0.51	6.71	13.26	0.51	5.94	13.56	0.44	5.94	13.56	0.44	5.94	13.56	0.44	5.94	13.56	0.44
	0	6.61	12.65	0.52	6.61	12.65	0.52	5.75	13.03	0.44	5.75	13.03	0.44	5.75	13.03	0.44	5.75	13.03	0.44
	5	6.39	11.85	0.54	6.39	11.85	0.54	5.69	12.40	0.46	5.69	12.40	0.46	5.69	12.40	0.46	5.69	12.40	0.46
	10	6.23	11.43	0.55	6.23	11.43	0.55	5.19	12.03	0.43	5.19	12.03	0.43	5.19	12.03	0.43	5.19	12.03	0.43
	15	7.47	10.33	0.72	6.64	10.90	0.61	4.80	11.45	0.42	4.04	11.56	0.35	4.04	11.56	0.35	4.04	11.56	0.35
	19	8.24	9.54	0.86	6.51	9.99	0.65	4.88	10.35	0.47	3.97	10.74	0.37	3.97	10.74	0.37	3.97	10.74	0.37
	20	8.44	8.40	1.01	6.45	9.13	0.71	4.83	9.62	0.50	3.93	10.06	0.39	3.93	10.06	0.39	3.93	10.06	0.39
	25	9.54	6.74	1.42	6.47	7.85	0.82	4.86	8.23	0.59	3.74	8.73	0.43	3.74	8.73	0.43	3.74	8.73	0.43
	30	10.31	5.42	1.90	6.48	6.54	0.99	4.79	6.90	0.69	3.57	7.45	0.48	3.57	7.45	0.48	3.57	7.45	0.48
	35	10.27	4.18	2.46	6.45	5.36	1.20	4.69	5.82	0.81	3.39	6.32	0.54	3.39	6.32	0.54	3.39	6.32	0.54
	40	8.53	3.75	2.27	6.42	4.58	1.40	4.83	5.00	0.96	3.29	5.51	0.60	3.29	5.51	0.60	3.29	5.51	0.60
43	7.62	3.56	2.14	6.51	4.10	1.59	4.91	4.51	1.09	3.18	5.02	0.63	3.18	5.02	0.63	3.18	5.02	0.63	
46	7.10	3.42	2.08	6.19	3.79	1.64	4.50	4.27	1.05	3.25	4.54	0.72	3.15	4.57	0.69	3.15	4.57	0.69	
25	-5	7.83	13.55	0.58	7.83	13.55	0.58	6.88	13.87	0.50	6.88	13.87	0.50	6.88	13.87	0.50	6.88	13.87	0.50
	0	7.57	13.20	0.57	7.57	13.20	0.57	6.66	13.40	0.50	6.66	13.40	0.50	6.66	13.40	0.50	6.66	13.40	0.50
	5	7.28	12.43	0.59	7.28	12.43	0.59	6.45	12.72	0.51	6.45	12.72	0.51	6.45	12.72	0.51	6.45	12.72	0.51
	10	7.13	11.63	0.61	7.13	11.63	0.61	5.96	12.10	0.49	5.83	12.15	0.48	5.83	12.15	0.48	5.83	12.15	0.48
	15	8.58	10.20	0.84	6.44	10.96	0.59	4.87	11.37	0.43	4.67	11.53	0.40	4.67	11.53	0.40	4.67	11.53	0.40
	19	9.45	9.00	1.05	6.41	9.91	0.65	4.83	10.32	0.47	4.59	10.52	0.44	4.59	10.52	0.44	4.59	10.52	0.44
	20	9.68	8.28	1.17	6.51	9.51	0.68	4.94	9.93	0.50	4.55	10.03	0.45	4.55	10.03	0.45	4.55	10.03	0.45
	25	10.65	7.17	1.49	6.55	8.38	0.78	4.85	8.74	0.56	4.34	9.03	0.48	4.34	9.03	0.48	4.34	9.03	0.48
	30	11.79	5.61	2.10	6.45	7.83	0.82	4.83	8.10	0.60	4.13	8.39	0.49	4.13	8.39	0.49	4.13	8.39	0.49
	35	11.70	4.62	2.53	6.46	6.44	1.00	4.88	6.90	0.71	3.94	7.30	0.54	3.94	7.30	0.54	3.94	7.30	0.54
	40	9.72	4.29	2.27	6.41	5.58	1.15	4.93	5.84	0.84	3.73	6.33	0.59	3.73	6.33	0.59	3.73	6.33	0.59
43	8.71	4.02	2.17	6.45	4.99	1.29	4.90	5.30	0.92	3.61	5.71	0.63	3.61	5.71	0.63	3.61	5.71	0.63	
46	8.22	3.86	2.13	6.20	4.56	1.36	4.43	5.02	0.88	3.66	5.22	0.70	3.66	5.22	0.70	3.66	5.22	0.70	

Abbreviations:

LWT: Leaving water temperature (°C)

DB: Dry-bulb temperature for Outdoor air temperature (°C)

CC: Total cooling capacity (kW)

PI: Power input (kW)

R290 M thermal Arctic HT Series



8kW Cooling Capacity

LWT	DB	Maximum			100%(Nonimal)			75%			50%			25%			Minimum		
		CC	EER	PI	CC	EER	PI	CC	EER	PI	CC	EER	PI	CC	EER	PI	CC	EER	PI
5	-5	/	/	/	/	/	/	/	/	/	/	/	/	/	/	/	/	/	/
	0	/	/	/	/	/	/	/	/	/	/	/	/	/	/	/	/	/	/
	5	/	/	/	/	/	/	/	/	/	/	/	/	/	/	/	/	/	/
	10	/	/	/	/	/	/	/	/	/	/	/	/	/	/	/	/	/	/
	15	/	/	/	/	/	/	/	/	/	/	/	/	/	/	/	/	/	/
	19	6.76	5.39	1.26	6.76	5.39	1.26	5.07	6.11	0.83	3.50	6.81	0.51	3.50	6.81	0.51	3.50	6.81	0.51
	20	6.82	5.18	1.32	6.82	5.18	1.32	5.11	5.80	0.88	3.47	6.56	0.53	3.47	6.56	0.53	3.47	6.56	0.53
	25	7.29	4.26	1.71	7.29	4.26	1.71	5.62	4.85	1.16	3.74	5.51	0.68	3.35	5.54	0.61	3.35	5.54	0.61
	30	7.67	3.57	2.15	7.48	3.63	2.06	5.61	4.40	1.28	3.72	4.82	0.77	3.21	4.92	0.65	3.21	4.92	0.65
	35	7.69	3.02	2.55	7.44	3.09	2.41	5.63	3.55	1.59	3.75	4.02	0.93	3.03	4.35	0.70	3.03	4.35	0.70
	40	6.76	2.77	2.44	6.76	2.77	2.44	4.92	3.10	1.59	3.14	3.43	0.91	2.85	3.62	0.79	2.85	3.62	0.79
	43	6.18	2.63	2.35	6.18	2.63	2.35	4.57	2.95	1.55	3.08	3.05	1.01	2.73	3.13	0.87	2.73	3.13	0.87
46	5.26	2.55	2.06	5.26	2.55	2.06	3.95	2.75	1.44	2.61	2.96	0.88	2.61	2.96	0.88	2.61	2.96	0.88	
7	-5	/	/	/	/	/	/	/	/	/	/	/	/	/	/	/	/	/	
	0	/	/	/	/	/	/	/	/	/	/	/	/	/	/	/	/	/	
	5	/	/	/	/	/	/	/	/	/	/	/	/	/	/	/	/	/	
	10	/	/	/	/	/	/	/	/	/	/	/	/	/	/	/	/	/	
	15	/	/	/	/	/	/	/	/	/	/	/	/	/	/	/	/	/	
	19	7.18	5.73	1.25	7.18	5.73	1.25	5.50	6.60	0.83	3.75	7.42	0.51	3.75	7.42	0.51	3.75	7.42	0.51
	20	7.24	5.51	1.31	7.24	5.51	1.31	5.53	6.38	0.87	3.72	7.14	0.52	3.72	7.14	0.52	3.72	7.14	0.52
	25	7.78	4.50	1.73	7.44	4.63	1.61	5.55	5.34	1.04	3.73	5.96	0.63	3.59	5.98	0.60	3.59	5.98	0.60
	30	8.17	3.76	2.17	7.48	3.99	1.87	5.56	4.51	1.24	3.71	4.93	0.75	3.44	4.98	0.69	3.44	4.98	0.69
	35	8.19	3.17	2.59	7.50	3.45	2.17	5.58	3.88	1.44	3.78	4.21	0.90	3.25	4.42	0.74	3.25	4.42	0.74
	40	7.23	2.92	2.48	7.23	2.92	2.48	5.58	3.30	1.69	3.69	3.66	1.01	3.06	3.80	0.80	3.06	3.80	0.80
	43	6.60	2.76	2.39	6.60	2.76	2.39	4.95	3.15	1.57	3.30	3.33	0.99	2.94	3.37	0.87	2.94	3.37	0.87
46	5.63	2.68	2.10	5.63	2.68	2.10	4.22	2.95	1.43	2.81	3.10	0.91	2.81	3.10	0.91	2.81	3.10	0.91	
10	-5	/	/	/	/	/	/	/	/	/	/	/	/	/	/	/	/	/	
	0	/	/	/	/	/	/	/	/	/	/	/	/	/	/	/	/	/	
	5	/	/	/	/	/	/	/	/	/	/	/	/	/	/	/	/	/	
	10	/	/	/	/	/	/	/	/	/	/	/	/	/	/	/	/	/	
	15	7.20	7.00	1.03	7.20	7.00	1.03	5.40	8.00	0.68	4.19	8.85	0.47	4.19	8.85	0.47	4.19	8.85	0.47
	19	7.91	6.26	1.26	7.63	6.30	1.21	5.73	7.47	0.77	4.15	8.10	0.51	4.15	8.10	0.51	4.15	8.10	0.51
	20	7.97	6.06	1.32	7.71	6.11	1.26	5.68	7.00	0.81	4.12	7.25	0.57	4.12	7.25	0.57	4.12	7.25	0.57
	25	8.54	4.88	1.75	7.67	5.24	1.46	5.75	6.21	0.93	3.98	6.75	0.59	3.98	6.75	0.59	3.98	6.75	0.59
	30	9.00	3.90	2.31	7.62	4.51	1.69	5.79	5.13	1.13	3.81	5.80	0.66	3.81	5.80	0.66	3.81	5.80	0.66
	35	8.98	3.34	2.69	7.67	3.79	2.03	5.73	4.38	1.31	3.90	4.82	0.81	3.61	4.96	0.73	3.61	4.96	0.73
	40	7.95	3.13	2.54	7.64	3.19	2.39	5.72	3.70	1.55	3.81	4.34	0.88	3.40	4.38	0.78	3.40	4.38	0.78
	43	7.26	2.96	2.45	7.26	2.96	2.45	5.44	3.43	1.59	3.63	4.04	0.90	3.25	4.09	0.79	3.25	4.09	0.79
46	6.20	2.89	2.14	6.20	2.89	2.14	4.65	3.12	1.49	3.12	3.61	0.86	3.12	3.61	0.86	3.12	3.61	0.86	
11	-5	/	/	/	/	/	/	/	/	/	/	/	/	/	/	/	/	/	
	0	/	/	/	/	/	/	/	/	/	/	/	/	/	/	/	/	/	
	5	/	/	/	/	/	/	/	/	/	/	/	/	/	/	/	/	/	
	10	6.21	8.12	0.77	5.49	8.22	0.67	5.15	9.21	0.56	5.15	9.21	0.56	5.15	9.21	0.56	5.15	9.21	0.56
	15	7.33	7.34	1.00	6.20	7.57	0.82	4.65	8.40	0.55	4.09	8.96	0.46	4.09	8.96	0.46	4.09	8.96	0.46
	19	8.04	6.28	1.28	7.10	6.70	1.06	5.33	7.92	0.67	4.06	8.48	0.48	4.06	8.48	0.48	4.06	8.48	0.48
	20	8.29	6.12	1.35	7.72	6.25	1.23	5.91	7.01	0.84	4.26	7.62	0.56	4.26	7.62	0.56	4.26	7.62	0.56
	25	8.83	5.02	1.76	7.80	5.27	1.48	5.81	6.24	0.93	4.12	7.02	0.59	4.12	7.02	0.59	4.12	7.02	0.59
	30	9.25	4.03	2.29	7.74	4.48	1.73	5.85	5.19	1.13	3.94	6.02	0.66	3.94	6.02	0.66	3.94	6.02	0.66
	35	9.26	3.47	2.67	7.80	3.82	2.04	5.79	4.54	1.27	3.88	5.06	0.77	3.74	5.10	0.73	3.74	5.10	0.73
	40	8.17	3.19	2.57	7.78	3.30	2.36	5.80	3.83	1.51	3.94	4.20	0.94	3.52	4.25	0.83	3.52	4.25	0.83
	43	7.50	3.03	2.47	7.50	3.03	2.47	5.80	3.46	1.67	3.94	3.92	1.00	3.38	3.96	0.85	3.38	3.96	0.85
46	7.20	2.92	2.47	7.20	2.92	2.47	5.40	3.23	1.67	3.60	3.43	1.05	3.23	3.45	0.94	3.23	3.45	0.94	
15	-5	7.35	12.19	0.60	7.35	12.19	0.60	6.54	12.60	0.52	6.54	12.60	0.52	6.54	12.60	0.52	6.54	12.60	0.52
	0	6.42	10.86	0.59	6.42	10.86	0.59	5.71	11.45	0.50	5.71	11.45	0.50	5.71	11.45	0.50	5.71	11.45	0.50
	5	6.23	9.90	0.63	6.23	9.90	0.63	5.58	10.52	0.53	5.58	10.52	0.53	5.58	10.52	0.53	5.58	10.52	0.53
	10	6.48	9.12	0.71	6.26	9.20	0.68	5.14	9.65	0.53	5.14	9.65	0.53	5.14	9.65	0.53	5.14	9.65	0.53
	15	8.27	7.98	1.04	8.08	8.17	0.99	6.06	9.22	0.66	4.71	9.43	0.50	4.71	9.43	0.50	4.71	9.43	0.50
	19	8.48	7.05	1.20	8.08	7.20	1.12	6.05	8.24	0.73	4.87	8.91	0.55	4.87	8.91	0.55	4.87	8.91	0.55
	20	8.71	6.45	1.35	8.08	6.76	1.20	6.06	7.78	0.78	4.84	8.40	0.58	4.84	8.40	0.58	4.84	8.40	0.58
	25	9.93	5.59	1.78	8.04	6.20	1.30	6.12	7.23	0.85	4.67	7.71	0.61	4.67	7.71	0.61	4.67	7.71	0.61
	30	10.38	4.55	2.28	8.01	5.19	1.54	6.04	6.20	0.97	4.48	6.52	0.69	4.48	6.52	0.69	4.48	6.52	0.69
	35	10.45	3.79	2.76	8.03	4.60	1.75	6.05	5.24	1.15	4.27	5.62	0.76	4.27	5.62	0.76	4.27	5.62	0.76
	40	9.25	3.49	2.65	8.10	3.82	2.12	6.10	4.44	1.37	4.03	4.73	0.85	4.03	4.73	0.85	4.03	4.73	0.85
	43	8.49	3.33	2.55	8.03	3.44	2.33	6.02	4.03	1.49	4.04	4.24	0.95	3.87	4.27	0.91	3.87	4.27	0.91
46	8.20	3.08	2.66	8.08	3.11	2.60	6.06	3.61	1.68	4.04	3.89	1.04	3.71	3.90	0.95	3.71	3.90	0.95	

LWT	DB	Maximum			100%(Nonimal)			75%			50%			25%			Minimum		
		CC	EER	PI	CC	EER	PI	CC	EER	PI	CC	EER	PI	CC	EER	PI	CC	EER	PI
18	-5	8.01	13.03	0.61	8.01	13.03	0.61	7.55	13.19	0.57	7.55	13.19	0.57	7.55	13.19	0.57	7.55	13.19	0.57
	0	7.03	11.95	0.59	7.03	11.95	0.59	6.26	12.35	0.51	6.26	12.35	0.51	6.26	12.35	0.51	6.26	12.35	0.51
	5	6.84	10.83	0.63	6.84	10.83	0.63	6.13	11.50	0.53	6.13	11.50	0.53	6.13	11.50	0.53	6.13	11.50	0.53
	10	6.87	9.71	0.71	6.87	9.71	0.71	5.70	10.84	0.53	5.70	10.84	0.53	5.70	10.84	0.53	5.70	10.84	0.53
	15	8.45	8.85	0.95	8.30	9.01	0.92	6.25	9.82	0.64	5.51	10.05	0.55	5.51	10.05	0.55	5.51	10.05	0.55
	19	8.83	8.00	1.10	8.30	8.25	1.01	6.20	9.04	0.69	5.35	9.14	0.58	5.35	9.14	0.58	5.35	9.14	0.58
	20	8.90	7.25	1.23	8.30	7.51	1.11	6.16	8.38	0.73	5.31	8.46	0.63	5.31	8.46	0.63	5.31	8.46	0.63
	25	10.84	6.05	1.79	8.33	7.01	1.19	6.20	7.65	0.81	5.13	7.99	0.64	5.13	7.99	0.64	5.13	7.99	0.64
	30	11.39	4.91	2.32	8.30	6.08	1.37	6.15	7.06	0.87	4.93	7.41	0.66	4.93	7.41	0.66	4.93	7.41	0.66
	35	11.36	4.03	2.82	8.30	5.15	1.61	6.19	6.08	1.02	4.69	6.27	0.75	4.69	6.27	0.75	4.69	6.27	0.75
	40	10.09	3.73	2.71	8.33	4.30	1.94	6.28	4.99	1.26	4.43	5.23	0.85	4.43	5.23	0.85	4.43	5.23	0.85
43	9.28	3.56	2.61	8.28	3.84	2.15	6.18	4.49	1.38	4.28	4.73	0.90	4.28	4.73	0.90	4.28	4.73	0.90	
46	7.96	3.52	2.26	7.96	3.52	2.26	5.97	4.09	1.46	4.10	4.26	0.96	4.10	4.26	0.96	4.10	4.26	0.96	
20	-5	8.48	13.51	0.63	8.48	13.51	0.63	8.01	13.81	0.58	8.01	13.81	0.58	8.01	13.81	0.58	8.01	13.81	0.58
	0	7.46	12.37	0.60	7.46	12.37	0.60	5.60	12.75	0.44	5.60	12.75	0.44	5.60	12.75	0.44	5.60	12.75	0.44
	5	7.16	11.35	0.63	7.16	11.35	0.63	6.70	12.05	0.56	6.70	12.05	0.56	6.70	12.05	0.56	6.70	12.05	0.56
	10	7.20	10.75	0.67	7.20	10.75	0.67	6.45	11.19	0.58	6.45	11.19	0.58	6.45	11.19	0.58	6.45	11.19	0.58
	15	8.52	9.68	0.88	8.12	10.05	0.81	7.00	10.35	0.68	7.00	10.35	0.68	7.00	10.35	0.68	7.00	10.35	0.68
	19	9.37	8.61	1.09	8.15	9.10	0.90	6.23	9.73	0.64	5.98	9.89	0.60	5.98	9.89	0.60	5.98	9.89	0.60
	20	9.44	7.86	1.20	8.22	8.35	0.98	6.23	8.69	0.72	5.89	8.79	0.67	5.89	8.79	0.67	5.89	8.79	0.67
	25	11.49	6.37	1.80	8.36	7.40	1.13	6.18	8.11	0.76	5.47	8.34	0.66	5.47	8.34	0.66	5.47	8.34	0.66
	30	12.05	5.24	2.30	8.21	7.02	1.17	6.16	7.44	0.83	5.25	7.70	0.68	5.25	7.70	0.68	5.25	7.70	0.68
	35	12.01	4.19	2.86	8.24	5.53	1.49	6.25	6.66	0.94	5.00	6.76	0.74	5.00	6.76	0.74	5.00	6.76	0.74
	40	10.68	3.89	2.75	8.23	4.63	1.78	6.22	5.48	1.14	4.71	5.60	0.84	4.71	5.60	0.84	4.71	5.60	0.84
43	9.89	3.78	2.62	8.20	4.20	1.95	6.14	4.91	1.25	4.53	5.04	0.90	4.53	5.04	0.90	4.53	5.04	0.90	
46	8.43	3.68	2.29	8.29	3.72	2.23	6.17	4.36	1.42	4.36	4.55	0.96	4.36	4.55	0.96	4.36	4.55	0.96	
25	-5	10.46	13.67	0.76	10.46	13.67	0.76	9.21	14.15	0.65	9.21	14.15	0.65	9.21	14.15	0.65	9.21	14.15	0.65
	0	9.55	13.19	0.72	9.55	13.25	0.72	8.27	13.85	0.60	8.27	13.85	0.60	8.27	13.85	0.60	8.27	13.85	0.60
	5	9.17	12.62	0.73	9.17	12.62	0.73	8.26	12.90	0.64	8.26	12.90	0.64	8.26	12.90	0.64	8.26	12.90	0.64
	10	9.41	11.84	0.79	8.39	12.01	0.70	7.78	12.12	0.64	7.78	12.12	0.64	7.78	12.12	0.64	7.78	12.12	0.64
	15	10.95	10.69	1.02	8.34	11.29	0.74	7.31	11.50	0.64	7.31	11.50	0.64	7.31	11.50	0.64	7.31	11.50	0.64
	19	12.18	9.81	1.24	8.30	10.25	0.81	6.93	10.75	0.64	6.93	10.75	0.64	6.93	10.75	0.64	6.93	10.75	0.64
	20	11.81	8.61	1.37	8.27	9.92	0.83	6.51	10.36	0.63	6.51	10.36	0.63	6.51	10.36	0.63	6.51	10.36	0.63
	25	12.12	7.73	1.57	8.29	9.01	0.92	6.35	9.75	0.65	6.35	9.75	0.65	6.35	9.75	0.65	6.35	9.75	0.65
	30	12.61	6.62	1.91	8.37	8.34	1.00	6.21	9.05	0.69	6.11	9.15	0.67	6.11	9.15	0.67	6.11	9.15	0.67
	35	13.22	5.18	2.55	8.32	7.11	1.17	6.13	8.06	0.76	5.79	8.13	0.71	5.79	8.13	0.71	5.79	8.13	0.71
	40	11.64	4.40	2.64	8.22	5.95	1.38	6.25	6.60	0.95	5.49	6.68	0.82	5.49	6.68	0.82	5.49	6.68	0.82
43	11.27	4.13	2.73	8.25	5.27	1.56	6.24	5.84	1.07	5.29	5.98	0.88	5.29	5.98	0.88	5.29	5.98	0.88	
46	9.70	3.95	2.46	8.37	4.63	1.81	6.19	5.32	1.16	5.08	5.36	0.95	5.08	5.36	0.95	5.08	5.36	0.95	

Abbreviations:

LWT: Leaving water temperature (°C)

DB: Dry-bulb temperature for Outdoor air temperature (°C)

CC: Total cooling capacity (kW)

PI: Power input (kW)

R290 M thermal Arctic HT Series



10kW Cooling Capacity

LWT	DB	Maximum			100%(Nonimal)			75%			50%			25%			Minimum		
		CC	EER	PI	CC	EER	PI	CC	EER	PI	CC	EER	PI	CC	EER	PI	CC	EER	PI
5	-5	/	/	/	/	/	/	/	/	/	/	/	/	/	/	/	/	/	/
	0	/	/	/	/	/	/	/	/	/	/	/	/	/	/	/	/	/	/
	5	/	/	/	/	/	/	/	/	/	/	/	/	/	/	/	/	/	/
	10	/	/	/	/	/	/	/	/	/	/	/	/	/	/	/	/	/	/
	15	/	/	/	/	/	/	/	/	/	/	/	/	/	/	/	/	/	/
	19	7.06	5.21	1.36	7.06	5.21	1.36	5.30	6.05	0.88	3.50	6.81	0.51	3.50	6.81	0.51	3.50	6.81	0.51
	20	7.23	4.97	1.45	7.23	4.97	1.45	5.41	5.75	0.94	3.61	6.53	0.55	3.47	6.56	0.53	3.47	6.56	0.53
	25	7.81	4.09	1.91	7.81	4.09	1.91	5.86	4.78	1.22	3.88	5.48	0.71	3.35	5.54	0.61	3.35	5.54	0.61
	30	8.20	3.41	2.40	8.20	3.41	2.40	6.15	4.32	1.42	4.06	4.76	0.85	3.21	4.92	0.65	3.21	4.92	0.65
	35	8.23	2.88	2.86	8.23	2.88	2.86	6.14	3.42	1.79	4.06	3.98	1.02	3.03	4.35	0.70	3.03	4.35	0.70
	40	6.76	2.77	2.44	6.76	2.77	2.44	5.02	3.06	1.64	3.32	3.42	0.97	2.85	3.62	0.79	2.85	3.62	0.79
43	6.18	2.63	2.35	6.18	2.63	2.35	4.57	2.95	1.55	3.08	3.05	1.01	2.73	3.13	0.87	2.73	3.13	0.87	
46	5.26	2.55	2.06	5.26	2.55	2.06	3.95	2.75	1.44	2.61	2.96	0.88	2.61	2.96	0.88	2.61	2.96	0.88	
7	-5	/	/	/	/	/	/	/	/	/	/	/	/	/	/	/	/	/	
	0	/	/	/	/	/	/	/	/	/	/	/	/	/	/	/	/	/	
	5	/	/	/	/	/	/	/	/	/	/	/	/	/	/	/	/	/	
	10	/	/	/	/	/	/	/	/	/	/	/	/	/	/	/	/	/	
	15	/	/	/	/	/	/	/	/	/	/	/	/	/	/	/	/	/	
	19	7.54	5.55	1.36	7.54	5.55	1.36	5.70	6.52	0.87	3.75	7.42	0.51	3.75	7.42	0.51	3.75	7.42	0.51
	20	7.72	5.29	1.46	7.72	5.29	1.46	5.65	6.32	0.89	3.86	7.07	0.55	3.72	7.14	0.52	3.72	7.14	0.52
	25	8.33	4.32	1.93	8.33	4.32	1.93	6.25	5.20	1.20	4.15	5.90	0.70	3.59	5.98	0.60	3.59	5.98	0.60
	30	8.73	3.58	2.44	8.73	3.58	2.44	6.55	4.33	1.51	4.37	4.90	0.89	3.44	4.98	0.69	3.44	4.98	0.69
	35	8.76	3.01	2.91	8.76	3.01	2.91	6.57	3.62	1.81	4.38	4.15	1.06	3.25	4.42	0.74	3.25	4.42	0.74
	40	7.23	2.92	2.48	7.23	2.92	2.48	5.58	3.30	1.69	3.69	3.66	1.01	3.06	3.80	0.80	3.06	3.80	0.80
43	6.60	2.76	2.39	6.60	2.76	2.39	4.95	3.15	1.57	3.30	3.33	0.99	2.94	3.37	0.87	2.94	3.37	0.87	
46	5.63	2.68	2.10	5.63	2.68	2.10	4.22	2.95	1.43	2.81	3.10	0.91	2.81	3.10	0.91	2.81	3.10	0.91	
10	-5	/	/	/	/	/	/	/	/	/	/	/	/	/	/	/	/	/	
	0	/	/	/	/	/	/	/	/	/	/	/	/	/	/	/	/	/	
	5	/	/	/	/	/	/	/	/	/	/	/	/	/	/	/	/	/	
	10	/	/	/	/	/	/	/	/	/	/	/	/	/	/	/	/	/	
	15	7.48	6.95	1.08	7.48	6.95	1.08	5.55	7.96	0.70	4.19	8.85	0.47	4.19	8.85	0.47	4.19	8.85	0.47
	19	8.30	6.11	1.36	8.30	6.11	1.36	6.16	7.28	0.85	4.15	8.10	0.51	4.15	8.10	0.51	4.15	8.10	0.51
	20	8.49	5.83	1.46	8.49	5.83	1.46	6.37	6.82	0.93	4.28	7.21	0.59	4.12	7.25	0.57	4.12	7.25	0.57
	25	9.15	4.68	1.96	9.15	4.68	1.96	6.76	5.90	1.15	4.59	6.61	0.69	3.98	6.75	0.59	3.98	6.75	0.59
	30	9.58	3.84	2.49	9.21	3.89	2.37	6.88	4.84	1.42	4.56	5.53	0.82	3.81	5.80	0.66	3.81	5.80	0.66
	35	9.60	3.22	2.98	9.20	3.30	2.79	6.87	4.06	1.69	4.57	4.63	0.99	3.61	4.96	0.73	3.61	4.96	0.73
	40	7.95	3.13	2.54	7.95	3.13	2.54	5.94	3.64	1.63	3.95	4.30	0.92	3.40	4.38	0.78	3.40	4.38	0.78
43	7.26	2.96	2.45	7.26	2.96	2.45	5.55	3.42	1.62	3.67	4.00	0.92	3.25	4.09	0.79	3.25	4.09	0.79	
46	6.20	2.89	2.14	6.20	2.89	2.14	4.65	3.12	1.49	3.12	3.61	0.86	3.12	3.61	0.86	3.12	3.61	0.86	
11	-5	/	/	/	/	/	/	/	/	/	/	/	/	/	/	/	/	/	
	0	/	/	/	/	/	/	/	/	/	/	/	/	/	/	/	/	/	
	5	/	/	/	/	/	/	/	/	/	/	/	/	/	/	/	/	/	
	10	6.74	7.92	0.85	6.74	7.92	0.85	5.15	9.21	0.56	5.15	9.21	0.56	5.15	9.21	0.56	5.15	9.21	0.56
	15	7.71	7.21	1.07	7.71	7.21	1.07	5.10	8.37	0.61	4.33	8.92	0.49	4.09	8.96	0.46	4.09	8.96	0.46
	19	8.56	6.16	1.39	8.56	6.16	1.39	6.36	7.65	0.83	4.29	8.41	0.51	4.06	8.48	0.48	4.06	8.48	0.48
	20	8.76	5.97	1.47	8.76	5.97	1.47	6.59	6.89	0.96	4.43	7.60	0.58	4.26	7.62	0.56	4.26	7.62	0.56
	25	9.43	4.88	1.93	9.43	4.88	1.93	6.93	5.96	1.16	4.59	6.87	0.67	4.12	7.02	0.59	4.12	7.02	0.59
	30	9.86	3.93	2.51	9.30	4.02	2.31	6.98	4.87	1.43	4.71	5.74	0.82	3.94	6.02	0.66	3.94	6.02	0.66
	35	9.90	3.29	3.01	9.26	3.52	2.63	6.98	4.26	1.64	4.60	4.83	0.95	3.74	5.10	0.73	3.74	5.10	0.73
	40	8.17	3.19	2.57	8.17	3.19	2.57	6.13	3.68	1.67	4.09	4.13	0.99	3.52	4.25	0.83	3.52	4.25	0.83
43	7.50	3.03	2.47	7.50	3.03	2.47	6.13	3.45	1.78	4.08	3.87	1.05	3.38	3.96	0.85	3.38	3.96	0.85	
46	7.20	2.92	2.47	7.20	2.92	2.47	5.40	3.23	1.67	3.60	3.43	1.05	3.23	3.45	0.94	3.23	3.45	0.94	
15	-5	8.12	12.09	0.67	8.12	12.09	0.67	6.54	12.60	0.52	6.54	12.60	0.52	6.54	12.60	0.52	6.54	12.60	0.52
	0	8.05	10.55	0.76	8.05	10.55	0.76	5.71	11.45	0.50	5.71	11.45	0.50	5.71	11.45	0.50	5.71	11.45	0.50
	5	7.82	9.60	0.81	7.82	9.60	0.81	5.58	10.52	0.53	5.58	10.52	0.53	5.58	10.52	0.53	5.58	10.52	0.53
	10	7.65	8.84	0.86	7.65	8.84	0.86	5.14	9.65	0.53	5.14	9.65	0.53	5.14	9.65	0.53	5.14	9.65	0.53
	15	8.79	7.79	1.13	8.79	8.02	1.10	7.25	8.86	0.82	4.71	9.43	0.50	4.71	9.43	0.50	4.71	9.43	0.50
	19	9.69	6.82	1.42	9.69	6.82	1.42	7.21	7.87	0.92	4.87	8.91	0.55	4.87	8.91	0.55	4.87	8.91	0.55
	20	9.91	6.10	1.62	9.61	6.32	1.52	7.31	7.35	0.99	4.84	8.40	0.58	4.84	8.40	0.58	4.84	8.40	0.58
	25	10.66	5.35	1.99	9.67	5.74	1.68	7.29	6.85	1.06	4.85	7.65	0.63	4.67	7.71	0.61	4.67	7.71	0.61
	30	11.11	4.31	2.58	9.68	4.87	1.99	7.31	5.83	1.25	4.82	6.41	0.75	4.48	6.72	0.67	4.48	6.72	0.67
	35	11.16	3.58	3.12	9.67	4.02	2.41	7.20	4.79	1.50	4.91	5.31	0.92	4.27	5.62	0.76	4.27	5.62	0.76
	40	9.25	3.49	2.65	9.25	3.49	2.65	6.82	4.22	1.62	4.66	4.59	1.02	4.03	4.73	0.85	4.03	4.73	0.85
43	8.49	3.33	2.55	8.49	3.33	2.55	6.34	3.92	1.62	4.17	4.06	1.03	3.87	4.27	0.91	3.87	4.27	0.91	
46	8.20	3.08	2.66	8.08	3.11	2.60	6.06	3.61	1.68	4.04	3.89	1.04	3.71	3.90	0.95	3.71	3.90	0.95	

LWT	DB	Maximum			100%(Nonimal)			75%			50%			25%			Minimum		
		CC	EER	PI	CC	EER	PI	CC	EER	PI	CC	EER	PI	CC	EER	PI	CC	EER	PI
18	-5	8.89	12.68	0.70	8.89	12.68	0.70	7.55	13.19	0.57	7.55	13.19	0.57	7.55	13.19	0.57	7.55	13.19	0.57
	0	8.79	11.52	0.76	8.79	11.52	0.76	6.26	12.35	0.51	6.26	12.35	0.51	6.26	12.35	0.51	6.26	12.35	0.51
	5	8.54	10.44	0.82	8.54	10.44	0.82	6.13	11.50	0.53	6.13	11.50	0.53	6.13	11.50	0.53	6.13	11.50	0.53
	10	8.36	9.36	0.89	8.36	9.36	0.89	6.27	10.66	0.59	5.70	10.84	0.53	5.70	10.84	0.53	5.70	10.84	0.53
	15	9.61	8.48	1.13	9.61	8.48	1.13	7.20	9.58	0.75	5.51	10.05	0.55	5.51	10.05	0.55	5.51	10.05	0.55
	19	10.60	7.36	1.44	9.92	7.62	1.30	7.56	8.87	0.85	5.35	9.14	0.58	5.35	9.14	0.58	5.35	9.14	0.58
	20	10.83	6.72	1.61	9.90	6.90	1.43	7.49	8.00	0.94	5.31	8.46	0.63	5.31	8.46	0.63	5.31	8.46	0.63
	25	11.55	5.70	2.03	9.89	6.51	1.52	7.52	7.23	1.04	5.13	7.99	0.64	5.13	7.99	0.64	5.13	7.99	0.64
	30	12.11	4.60	2.63	9.99	5.49	1.82	7.42	6.70	1.11	4.93	7.41	0.66	4.93	7.41	0.66	4.93	7.41	0.66
	35	12.13	3.79	3.20	10.00	4.75	2.11	7.48	5.51	1.36	5.04	6.23	0.81	4.69	6.27	0.75	4.69	6.27	0.75
	40	10.09	3.73	2.71	9.98	3.77	2.65	7.48	4.58	1.63	4.96	5.13	0.97	4.43	5.23	0.85	4.43	5.23	0.85
43	9.28	3.56	2.61	9.28	3.56	2.61	6.96	4.25	1.64	4.59	4.71	0.97	4.28	4.73	0.90	4.28	4.73	0.90	
46	7.96	3.52	2.26	7.96	3.52	2.26	5.97	4.09	1.46	4.10	4.26	0.96	4.10	4.26	0.96	4.10	4.26	0.96	
20	-5	9.40	13.16	0.71	9.40	13.16	0.71	8.01	13.81	0.58	8.01	13.81	0.58	8.01	13.81	0.58	8.01	13.81	0.58
	0	9.32	12.11	0.77	9.32	12.11	0.77	5.60	12.75	0.59	5.60	12.75	0.59	5.60	12.75	0.44	5.60	12.75	0.44
	5	9.05	11.07	0.82	9.05	11.07	0.82	6.70	12.05	0.59	6.70	12.05	0.59	6.70	12.05	0.56	6.70	12.05	0.56
	10	8.88	10.28	0.86	8.88	10.28	0.86	6.45	11.19	0.64	6.45	11.19	0.64	6.45	11.19	0.58	6.45	11.19	0.58
	15	10.19	9.23	1.10	10.19	9.23	1.10	7.50	10.21	0.73	7.00	10.35	0.68	7.00	10.35	0.68	7.00	10.35	0.68
	19	11.23	8.14	1.38	9.99	8.67	1.15	7.46	9.42	0.79	5.98	9.89	0.60	5.98	9.89	0.60	5.98	9.89	0.60
	20	11.52	7.25	1.59	9.89	8.01	1.23	7.41	8.55	0.87	5.89	8.79	0.67	5.89	8.79	0.67	5.89	8.79	0.67
	25	12.23	6.15	1.99	10.03	7.02	1.43	7.48	7.75	0.97	5.47	8.34	0.66	5.47	8.34	0.66	5.47	8.34	0.66
	30	12.80	5.08	2.52	9.97	6.75	1.48	7.55	7.21	1.05	5.25	7.70	0.68	5.25	7.70	0.68	5.25	7.70	0.68
	35	12.81	4.05	3.16	9.94	5.15	1.93	7.48	6.23	1.20	5.00	6.76	0.74	5.00	6.76	0.74	5.00	6.76	0.74
	40	10.68	3.89	2.75	9.95	4.16	2.39	7.54	5.00	1.51	5.09	5.55	0.92	4.71	5.60	0.84	4.71	5.60	0.84
43	9.89	3.78	2.62	9.89	3.78	2.62	7.38	4.49	1.64	5.07	4.94	1.03	4.53	5.04	0.90	4.53	5.04	0.90	
46	8.43	3.68	2.29	8.43	3.68	2.29	6.32	4.34	1.46	4.36	4.55	0.96	4.36	4.55	0.96	4.36	4.55	0.96	
25	-5	11.00	13.48	0.82	11.00	13.48	0.82	9.21	14.15	0.65	9.21	14.15	0.65	9.21	14.15	0.65	9.21	14.15	0.65
	0	10.67	12.80	0.83	10.67	12.80	0.83	8.27	13.85	0.60	8.27	13.85	0.60	8.27	13.85	0.60	8.27	13.85	0.60
	5	10.40	12.16	0.86	10.40	12.16	0.86	8.50	12.81	0.66	8.26	12.90	0.64	8.26	12.90	0.64	8.26	12.90	0.64
	10	10.24	11.65	0.88	10.24	11.65	0.88	8.28	12.00	0.69	7.78	12.12	0.64	7.78	12.12	0.64	7.78	12.12	0.64
	15	11.73	10.48	1.12	10.07	11.02	0.91	7.48	11.44	0.65	7.31	11.50	0.64	7.31	11.50	0.64	7.31	11.50	0.64
	19	12.47	9.69	1.29	9.92	10.01	0.99	7.48	10.58	0.71	6.93	10.75	0.64	6.93	10.75	0.64	6.93	10.75	0.64
	20	12.17	8.52	1.43	9.92	9.50	1.04	7.61	9.97	0.76	6.51	10.36	0.63	6.51	10.36	0.63	6.51	10.36	0.63
	25	12.49	7.65	1.63	10.05	8.52	1.18	7.39	9.28	0.80	6.35	9.75	0.65	6.35	9.75	0.65	6.35	9.75	0.65
	30	13.00	6.55	1.98	10.03	7.94	1.26	7.58	8.53	0.89	6.11	9.15	0.67	6.11	9.15	0.67	6.11	9.15	0.67
	35	13.63	5.13	2.66	9.87	6.64	1.49	7.60	7.75	0.98	5.79	8.13	0.71	5.79	8.13	0.71	5.79	8.13	0.71
	40	11.99	4.36	2.75	10.00	5.39	1.85	7.55	6.27	1.20	5.49	6.68	0.82	5.49	6.68	0.82	5.49	6.68	0.82
43	11.27	4.13	2.73	9.95	4.80	2.07	7.46	5.36	1.39	5.29	5.98	0.88	5.29	5.98	0.88	5.29	5.98	0.88	
46	9.70	3.95	2.46	9.70	3.95	2.46	7.27	4.70	1.55	5.08	5.36	0.95	5.08	5.36	0.95	5.08	5.36	0.95	

Abbreviations:

LWT: Leaving water temperature (°C)

DB: Dry-bulb temperature for Outdoor air temperature (°C)

CC: Total cooling capacity (kW)

PI: Power input (kW)

R290 M thermal Arctic HT Series



12kW Cooling Capacity

LWT	DB	Maximum			100%(Nonimal)			75%			50%			25%			Minimum		
		CC	EER	PI	CC	EER	PI	CC	EER	PI	CC	EER	PI	CC	EER	PI	CC	EER	PI
5	-5	/	/	/	/	/	/	/	/	/	/	/	/	/	/	/	/	/	/
	0	/	/	/	/	/	/	/	/	/	/	/	/	/	/	/	/	/	/
	5	/	/	/	/	/	/	/	/	/	/	/	/	/	/	/	/	/	/
	10	/	/	/	/	/	/	/	/	/	/	/	/	/	/	/	/	/	/
	15	/	/	/	/	/	/	/	/	/	/	/	/	/	/	/	/	/	/
	19	9.56	5.20	1.84	9.56	5.20	1.84	8.60	5.37	1.60	5.84	5.72	1.02	4.46	5.93	0.75	4.46	5.93	0.75
	20	9.82	4.94	1.99	9.82	4.94	1.99	8.59	5.21	1.65	5.79	5.53	1.05	4.44	5.74	0.77	4.44	5.74	0.77
	25	10.63	3.97	2.68	10.63	3.97	2.68	8.71	4.41	1.97	5.71	4.71	1.21	4.27	4.92	0.87	4.27	4.92	0.87
	30	11.13	3.28	3.39	11.13	3.28	3.39	8.64	3.78	2.28	5.85	4.01	1.46	4.12	4.26	0.97	4.12	4.26	0.97
	35	11.25	2.79	4.03	11.25	2.79	4.03	8.62	3.21	2.69	5.76	3.51	1.64	3.90	3.66	1.07	3.90	3.66	1.07
	40	9.88	2.56	3.86	9.88	2.56	3.86	8.66	2.76	3.14	5.75	3.02	1.90	3.71	3.17	1.17	3.71	3.17	1.17
	43	8.60	2.45	3.51	8.60	2.45	3.51	8.55	2.48	3.45	5.73	2.79	2.05	3.57	2.89	1.23	3.57	2.89	1.23
46	6.64	2.31	2.88	6.64	2.31	2.88	6.64	2.31	2.88	5.75	2.45	2.34	3.48	2.67	1.30	3.48	2.67	1.30	
7	-5	/	/	/	/	/	/	/	/	/	/	/	/	/	/	/	/	/	
	0	/	/	/	/	/	/	/	/	/	/	/	/	/	/	/	/	/	/
	5	/	/	/	/	/	/	/	/	/	/	/	/	/	/	/	/	/	/
	10	/	/	/	/	/	/	/	/	/	/	/	/	/	/	/	/	/	/
	15	/	/	/	/	/	/	/	/	/	/	/	/	/	/	/	/	/	/
	19	10.19	5.53	1.84	10.19	5.53	1.84	8.59	6.02	1.43	5.69	6.18	0.92	4.79	6.39	0.75	4.79	6.39	0.75
	20	10.46	5.24	1.99	10.46	5.24	1.99	8.51	5.64	1.51	5.68	6.04	0.94	4.76	6.18	0.77	4.76	6.18	0.77
	25	11.32	4.18	2.71	11.32	4.18	2.71	8.67	4.90	1.77	5.71	5.11	1.12	4.57	5.28	0.87	4.57	5.28	0.87
	30	11.85	3.44	3.44	11.56	3.51	3.29	8.71	4.22	2.06	5.68	4.35	1.31	4.40	4.55	0.97	4.40	4.55	0.97
	35	11.96	2.99	4.00	11.50	3.05	3.77	8.57	3.60	2.38	5.81	3.76	1.54	4.17	3.90	1.07	4.17	3.90	1.07
	40	10.57	2.70	3.91	10.57	2.70	3.91	8.58	3.05	2.81	5.82	3.23	1.80	3.97	3.37	1.18	3.97	3.37	1.18
	43	9.13	2.55	3.58	9.13	2.55	3.58	8.61	2.64	3.26	5.82	2.98	1.95	3.82	3.07	1.24	3.82	3.07	1.24
46	7.08	2.42	2.93	7.08	2.42	2.93	7.08	2.42	2.93	5.75	2.60	2.21	3.72	2.83	1.31	3.72	2.83	1.31	
10	-5	/	/	/	/	/	/	/	/	/	/	/	/	/	/	/	/	/	
	0	/	/	/	/	/	/	/	/	/	/	/	/	/	/	/	/	/	/
	5	/	/	/	/	/	/	/	/	/	/	/	/	/	/	/	/	/	/
	10	/	/	/	/	/	/	/	/	/	/	/	/	/	/	/	/	/	/
	15	10.09	7.20	1.40	10.09	7.20	1.40	8.78	7.75	1.13	5.85	8.34	0.70	5.41	8.37	0.65	5.41	8.37	0.65
	19	11.19	6.08	1.84	11.19	6.08	1.84	8.80	6.85	1.28	5.70	7.27	0.78	5.33	7.37	0.72	5.33	7.37	0.72
	20	11.49	5.74	2.00	11.49	5.74	2.00	8.72	6.62	1.32	5.85	7.01	0.84	5.29	7.10	0.74	5.29	7.10	0.74
	25	12.40	4.51	2.75	11.69	4.73	2.47	8.73	5.56	1.57	5.89	5.83	1.01	5.05	5.89	0.86	5.05	5.89	0.86
	30	12.97	3.70	3.51	11.71	4.03	2.91	8.81	4.68	1.88	5.85	4.86	1.20	4.85	5.04	0.96	4.85	5.04	0.96
	35	13.05	3.10	4.21	11.63	3.43	3.39	8.71	4.08	2.13	5.81	4.20	1.38	4.60	4.29	1.07	4.60	4.29	1.07
	40	11.55	2.80	4.12	10.57	3.02	3.50	8.80	3.45	2.55	5.88	3.57	1.65	4.38	3.69	1.19	4.38	3.69	1.19
	43	10.04	2.74	3.66	10.04	2.74	3.66	8.69	2.99	2.91	5.90	3.28	1.80	4.22	3.35	1.26	4.22	3.35	1.26
46	7.80	2.61	2.99	7.80	2.61	2.99	7.80	2.61	2.99	5.82	2.99	1.95	4.12	3.10	1.33	4.12	3.10	1.33	
11	-5	/	/	/	/	/	/	/	/	/	/	/	/	/	/	/	/	/	
	0	/	/	/	/	/	/	/	/	/	/	/	/	/	/	/	/	/	/
	5	/	/	/	/	/	/	/	/	/	/	/	/	/	/	/	/	/	/
	10	8.97	9.13	0.98	8.97	9.13	0.98	8.76	9.40	0.93	7.23	9.99	0.72	7.23	9.99	0.72	7.23	9.99	0.72
	15	10.40	7.44	1.40	10.40	7.44	1.40	8.83	8.15	1.08	6.05	8.72	0.69	5.60	8.76	0.64	5.60	8.76	0.64
	19	11.54	6.27	1.84	11.54	6.27	1.84	8.85	7.17	1.24	5.77	7.60	0.76	5.48	7.63	0.72	5.48	7.63	0.72
	20	11.84	5.91	2.00	11.64	6.00	1.94	8.77	6.92	1.27	5.81	7.37	0.79	5.47	7.41	0.74	5.47	7.41	0.74
	25	12.78	4.63	2.76	11.67	4.97	2.35	8.80	5.78	1.52	5.78	6.13	0.94	5.25	6.17	0.85	5.25	6.17	0.85
	30	13.36	3.78	3.53	11.72	4.22	2.78	8.69	5.01	1.73	5.71	5.16	1.10	5.00	5.21	0.96	5.00	5.21	0.96
	35	13.44	3.17	4.24	11.68	3.59	3.25	8.81	4.25	2.07	5.64	4.41	1.28	4.79	4.47	1.07	4.79	4.47	1.07
	40	11.89	2.93	4.05	11.76	2.96	3.97	8.74	3.52	2.48	5.78	3.79	1.52	4.61	3.86	1.20	4.61	3.86	1.20
	43	10.34	2.80	3.69	10.34	2.80	3.69	8.81	3.10	2.84	5.74	3.42	1.68	4.45	3.51	1.27	4.45	3.51	1.27
46	8.05	2.68	3.01	8.05	2.68	3.01	8.05	2.68	3.01	5.84	3.08	1.90	4.26	3.19	1.33	4.26	3.19	1.33	
15	-5	9.88	12.96	0.76	9.88	12.96	0.76	9.88	12.96	0.76	8.90	13.65	0.65	8.90	13.65	0.65	8.90	13.65	0.65
	0	10.00	12.18	0.82	10.00	12.18	0.82	10.00	12.34	0.81	8.91	12.86	0.69	8.91	12.86	0.69	8.91	12.86	0.69
	5	10.27	10.97	0.94	10.27	10.97	0.94	8.89	11.83	0.75	8.89	11.83	0.75	8.89	11.83	0.75	8.89	11.83	0.75
	10	10.10	9.60	1.05	10.10	9.60	1.05	8.80	10.40	0.85	8.19	10.75	0.76	8.19	10.75	0.76	8.19	10.75	0.76
	15	11.68	8.26	1.41	11.68	8.26	1.41	8.94	10.20	0.88	6.39	10.59	0.60	6.39	10.59	0.60	6.39	10.59	0.60
	19	13.03	7.14	1.83	11.73	7.55	1.55	8.99	8.74	1.03	6.28	9.19	0.68	6.28	9.19	0.68	6.28	9.19	0.68
	20	13.35	6.68	2.00	11.85	7.16	1.65	8.91	8.41	1.06	6.22	8.77	0.71	6.22	8.77	0.71	6.22	8.77	0.71
	25	14.35	5.11	2.81	11.86	6.04	1.97	9.00	6.85	1.31	5.95	7.18	0.83	5.95	7.18	0.83	5.95	7.18	0.83
	30	15.04	4.16	3.62	11.83	5.12	2.31	8.95	5.86	1.53	6.02	6.21	0.97	5.69	6.34	0.90	5.69	6.34	0.90
	35	14.86	3.50	4.24	11.84	4.17	2.84	8.93	4.95	1.81	5.95	5.12	1.16	5.39	5.18	1.04	5.39	5.18	1.04
	40	13.31	3.19	4.17	12.01	3.47	3.46	8.91	4.14	2.15	6.05	4.30	1.41	5.11	4.36	1.17	5.11	4.36	1.17
	43	11.58	3.05	3.80	11.58	3.05	3.80	8.97	3.61	2.49	5.87	3.81	1.54	4.93	3.87	1.27	4.93	3.87	1.27
46	9.05	2.93	3.08	9.05	2.93	3.08	9.05	2.93	3.08	5.93	3.46	1.72	4.83	3.59	1.35	4.83	3.59	1.35	

LWT	DB	Maximum			100%(Nonimal)			75%			50%			25%			Minimum		
		CC	EER	PI	CC	EER	PI	CC	EER	PI	CC	EER	PI	CC	EER	PI	CC	EER	PI
18	-5	10.78	13.48	0.80	10.78	13.48	0.80	9.72	14.10	0.69	9.72	14.10	0.69	9.72	14.10	0.69	9.72	14.10	0.69
	0	10.91	12.96	0.84	10.91	12.96	0.84	9.74	13.70	0.71	9.74	13.70	0.71	9.74	13.70	0.71	9.74	13.70	0.71
	5	11.21	12.20	0.92	11.21	12.20	0.92	9.71	13.13	0.74	9.71	13.13	0.74	9.71	13.13	0.74	9.71	13.13	0.74
	10	11.05	11.69	0.94	11.05	11.69	0.94	8.95	12.30	0.73	8.95	12.30	0.73	8.95	12.30	0.73	8.95	12.30	0.73
	15	12.80	8.92	1.44	12.01	9.41	1.28	8.71	10.68	0.82	7.04	11.34	0.62	7.04	11.34	0.62	7.04	11.34	0.62
	19	14.21	7.83	1.81	12.03	8.75	1.37	9.06	9.93	0.91	6.99	10.49	0.67	6.99	10.49	0.67	6.99	10.49	0.67
	20	14.56	7.31	1.99	11.92	8.43	1.41	9.01	9.08	0.99	6.94	10.00	0.69	6.94	10.00	0.69	6.94	10.00	0.69
	25	15.67	5.52	2.84	11.90	6.71	1.77	9.01	7.81	1.15	6.63	8.33	0.80	6.63	8.33	0.80	6.63	8.33	0.80
	30	16.33	4.43	3.68	11.96	5.65	2.12	9.03	6.66	1.36	6.34	6.87	0.92	6.34	6.87	0.92	6.34	6.87	0.92
	35	16.40	3.66	4.48	12.00	4.50	2.67	9.06	5.54	1.64	6.08	5.72	1.06	6.08	5.72	1.06	6.08	5.72	1.06
	40	14.68	3.46	4.24	12.01	3.90	3.08	9.09	4.48	2.03	6.02	4.94	1.22	5.61	5.01	1.12	5.61	5.01	1.12
43	12.60	3.24	3.88	12.09	3.30	3.66	9.01	4.05	2.23	6.03	4.28	1.41	5.50	4.34	1.27	5.50	4.34	1.27	
46	9.88	3.15	3.14	9.88	3.15	3.14	9.00	3.34	2.69	6.00	3.88	1.54	5.31	3.93	1.35	5.31	3.93	1.35	
20	-5	11.40	13.93	0.82	11.40	13.93	0.82	10.31	15.42	0.67	10.31	15.42	0.67	10.31	15.42	0.67	10.31	15.42	0.67
	0	11.54	13.67	0.84	11.54	13.67	0.84	10.32	14.96	0.69	10.32	14.96	0.69	10.32	14.96	0.69	10.32	14.96	0.69
	5	11.87	13.06	0.91	11.87	13.06	0.91	10.29	14.20	0.73	10.29	14.20	0.73	10.29	14.20	0.73	10.29	14.20	0.73
	10	11.72	11.80	0.99	11.72	11.80	0.99	9.49	13.12	0.72	9.49	13.12	0.72	9.49	13.12	0.72	9.49	13.12	0.72
	15	13.54	9.63	1.41	12.15	10.08	1.20	8.94	11.05	0.81	7.47	11.50	0.65	7.47	11.50	0.65	7.47	11.50	0.65
	19	15.05	8.02	1.88	12.19	9.31	1.31	8.91	10.32	0.86	7.42	10.60	0.70	7.42	10.60	0.70	7.42	10.60	0.70
	20	15.41	7.46	2.07	11.80	9.09	1.30	9.13	9.86	0.93	7.39	10.40	0.71	7.39	10.40	0.71	7.39	10.40	0.71
	25	16.57	5.81	2.85	11.78	7.61	1.55	9.06	8.76	1.03	7.07	9.13	0.77	7.07	9.13	0.77	7.07	9.13	0.77
	30	17.49	4.84	3.61	11.95	6.51	1.84	9.02	7.14	1.26	6.80	7.41	0.92	6.80	7.41	0.92	6.80	7.41	0.92
	35	17.29	3.81	4.54	12.07	5.32	2.27	9.11	5.84	1.56	6.48	6.18	1.05	6.48	6.18	1.05	6.48	6.18	1.05
	40	15.25	3.52	4.33	12.05	4.32	2.79	8.93	4.85	1.84	5.96	5.21	1.14	5.96	5.21	1.14	5.96	5.21	1.14
43	13.31	3.38	3.94	12.05	3.90	3.09	9.07	4.29	2.12	5.87	4.65	1.26	5.87	4.65	1.26	5.87	4.65	1.26	
46	10.46	3.30	3.17	10.46	3.30	3.17	9.00	3.71	2.42	6.07	4.21	1.44	5.65	4.18	1.35	5.65	4.18	1.35	
25	-5	12.45	14.64	0.85	11.90	15.49	0.77	11.90	15.49	0.77	11.90	15.49	0.77	11.90	15.49	0.77	11.90	15.49	0.77
	0	12.60	14.34	0.88	11.91	15.11	0.79	11.91	15.11	0.79	11.91	15.11	0.79	11.91	15.11	0.79	11.91	15.11	0.79
	5	12.97	13.66	0.95	12.00	14.13	0.85	11.88	14.47	0.82	11.88	14.47	0.82	11.88	14.47	0.82	11.88	14.47	0.82
	10	12.83	12.65	1.01	12.00	13.00	0.92	10.97	13.39	0.82	10.97	13.39	0.82	10.97	13.39	0.82	10.97	13.39	0.82
	15	14.74	10.63	1.39	11.99	11.34	1.06	9.14	12.18	0.75	8.70	12.26	0.71	8.70	12.26	0.71	8.70	12.26	0.71
	19	16.40	9.80	1.67	12.00	10.98	1.09	9.11	11.22	0.81	8.66	11.26	0.77	8.66	11.26	0.77	8.66	11.26	0.77
	20	16.78	9.02	1.86	11.90	10.25	1.16	9.06	10.66	0.85	8.62	10.70	0.81	8.62	10.70	0.81	8.62	10.70	0.81
	25	17.93	6.51	2.75	11.81	8.52	1.39	8.96	8.97	1.00	8.23	9.25	0.89	8.23	9.25	0.89	8.23	9.25	0.89
	30	18.60	5.11	3.64	12.02	7.40	1.62	8.99	8.03	1.12	7.82	8.21	0.95	7.82	8.21	0.95	7.82	8.21	0.95
	35	18.53	4.14	4.48	12.01	6.71	1.79	8.98	7.28	1.23	7.55	7.52	1.00	7.55	7.52	1.00	7.55	7.52	1.00
	40	16.49	3.87	4.26	12.15	5.49	2.21	8.78	6.13	1.43	6.92	6.72	1.03	6.92	6.72	1.03	6.92	6.72	1.03
43	14.39	3.73	3.86	12.02	4.55	2.64	8.91	5.11	1.74	6.83	6.02	1.13	6.83	6.02	1.13	6.83	6.02	1.13	
46	11.54	3.66	3.15	11.54	3.66	3.15	9.00	4.45	2.02	6.58	4.89	1.35	6.58	4.89	1.35	6.58	4.89	1.35	

Abbreviations:

LWT: Leaving water temperature (°C)

DB: Dry-bulb temperature for Outdoor air temperature (°C)

CC: Total cooling capacity (kW)

PI: Power input (kW)

R290 M thermal Arctic HT Series



14kW Cooling Capacity

LWT	DB	Maximum			100%(Nonimal)			75%			50%			25%			Minimum		
		CC	EER	PI	CC	EER	PI	CC	EER	PI	CC	EER	PI	CC	EER	PI	CC	EER	PI
5	-5	/	/	/	/	/	/	/	/	/	/	/	/	/	/	/	/	/	/
	0	/	/	/	/	/	/	/	/	/	/	/	/	/	/	/	/	/	/
	5	/	/	/	/	/	/	/	/	/	/	/	/	/	/	/	/	/	/
	10	/	/	/	/	/	/	/	/	/	/	/	/	/	/	/	/	/	/
	15	/	/	/	/	/	/	/	/	/	/	/	/	/	/	/	/	/	/
	19	10.25	4.96	2.06	10.25	4.96	2.06	9.55	5.19	1.84	6.43	5.59	1.15	4.46	5.93	0.75	4.46	5.93	0.75
	20	10.32	4.77	2.16	10.32	4.77	2.16	9.64	4.99	1.93	6.37	5.41	1.18	4.44	5.74	0.77	4.44	5.74	0.77
	25	11.21	3.79	2.96	11.21	3.79	2.96	9.52	4.25	2.24	6.44	4.60	1.40	4.27	4.92	0.87	4.27	4.92	0.87
	30	11.92	3.11	3.83	11.92	3.11	3.83	9.56	3.63	2.63	6.36	3.97	1.60	4.12	4.26	0.97	4.12	4.26	0.97
	35	11.98	2.65	4.52	11.98	2.65	4.52	9.54	3.11	3.07	6.40	3.45	1.86	3.90	3.66	1.07	3.90	3.66	1.07
	40	9.88	2.56	3.86	9.88	2.56	3.86	9.54	2.63	3.62	6.34	2.98	2.13	3.71	3.17	1.17	3.71	3.17	1.17
43	8.60	2.45	3.51	8.60	2.45	3.51	8.60	2.45	3.51	6.30	2.72	2.31	3.57	2.89	1.23	3.57	2.89	1.23	
46	6.64	2.31	2.88	6.64	2.31	2.88	6.64	2.31	2.88	6.35	2.37	2.68	3.48	2.67	1.30	3.48	2.67	1.30	
7	-5	/	/	/	/	/	/	/	/	/	/	/	/	/	/	/	/	/	
	0	/	/	/	/	/	/	/	/	/	/	/	/	/	/	/	/	/	
	5	/	/	/	/	/	/	/	/	/	/	/	/	/	/	/	/	/	
	10	/	/	/	/	/	/	/	/	/	/	/	/	/	/	/	/	/	
	15	/	/	/	/	/	/	/	/	/	/	/	/	/	/	/	/	/	
	19	10.92	5.26	2.07	10.92	5.26	2.07	9.62	5.74	1.68	6.44	6.11	1.05	4.79	6.39	0.75	4.79	6.39	0.75
	20	11.00	5.06	2.17	11.00	5.06	2.17	9.54	5.57	1.71	6.38	5.78	1.10	4.76	6.18	0.77	4.76	6.18	0.77
	25	11.93	3.99	2.99	11.93	3.99	2.99	9.63	4.65	2.07	6.31	5.00	1.26	4.57	5.28	0.87	4.57	5.28	0.87
	30	12.67	3.25	3.89	12.67	3.25	3.89	9.54	3.99	2.39	6.43	4.26	1.51	4.40	4.55	0.97	4.40	4.55	0.97
	35	12.70	2.90	4.38	12.70	2.90	4.38	9.56	3.39	2.82	6.32	3.71	1.71	4.17	3.90	1.07	4.17	3.90	1.07
	40	10.57	2.70	3.91	10.57	2.70	3.91	9.51	2.90	3.28	6.30	3.19	1.98	3.97	3.37	1.18	3.97	3.37	1.18
43	9.13	2.55	3.58	9.13	2.55	3.58	9.13	2.55	3.58	6.28	2.88	2.18	3.82	3.07	1.24	3.82	3.07	1.24	
46	7.08	2.42	2.93	7.08	2.42	2.93	7.08	2.42	2.93	6.35	2.50	2.54	3.72	2.83	1.31	3.72	2.83	1.31	
10	-5	/	/	/	/	/	/	/	/	/	/	/	/	/	/	/	/	/	
	0	/	/	/	/	/	/	/	/	/	/	/	/	/	/	/	/	/	
	5	/	/	/	/	/	/	/	/	/	/	/	/	/	/	/	/	/	
	10	/	/	/	/	/	/	/	/	/	/	/	/	/	/	/	/	/	
	15	10.50	6.95	1.51	10.50	6.95	1.51	9.86	7.26	1.36	6.49	8.21	0.79	5.41	8.37	0.65	5.41	8.37	0.65
	19	11.99	5.77	2.08	11.99	5.77	2.08	9.86	6.51	1.52	6.64	7.15	0.93	5.33	7.37	0.72	5.33	7.37	0.72
	20	12.07	5.53	2.18	12.07	5.53	2.18	9.77	6.30	1.55	6.59	6.89	0.96	5.29	7.10	0.74	5.29	7.10	0.74
	25	13.07	4.30	3.04	13.07	4.30	3.04	9.71	5.25	1.85	6.50	5.74	1.13	5.05	5.89	0.86	5.05	5.89	0.86
	30	13.86	3.48	3.98	13.11	3.65	3.59	9.76	4.54	2.15	6.46	4.78	1.35	4.85	5.04	0.96	4.85	5.04	0.96
	35	13.87	2.92	4.74	13.05	3.10	4.21	9.83	3.83	2.57	6.59	4.11	1.61	4.60	4.29	1.07	4.60	4.29	1.07
	40	11.55	2.80	4.12	11.55	2.80	4.12	9.74	3.22	3.02	6.59	3.51	1.88	4.38	3.69	1.19	4.38	3.69	1.19
43	10.04	2.74	3.66	10.04	2.74	3.66	9.88	2.80	3.53	6.58	3.16	2.08	4.22	3.35	1.26	4.22	3.35	1.26	
46	7.80	2.61	2.99	7.80	2.61	2.99	7.80	2.61	2.99	6.53	2.84	2.30	4.12	3.10	1.33	4.12	3.10	1.33	
11	-5	/	/	/	/	/	/	/	/	/	/	/	/	/	/	/	/	/	
	0	/	/	/	/	/	/	/	/	/	/	/	/	/	/	/	/	/	
	5	/	/	/	/	/	/	/	/	/	/	/	/	/	/	/	/	/	
	10	9.45	9.04	1.04	9.45	9.04	1.04	9.45	9.04	1.04	7.23	9.99	0.72	7.23	9.99	0.72	7.23	9.99	0.72
	15	10.84	7.18	1.51	10.84	7.18	1.51	9.73	7.69	1.26	6.70	8.54	0.78	5.60	8.76	0.64	5.60	8.76	0.64
	19	12.36	5.95	2.08	12.36	5.95	2.08	9.74	6.86	1.42	6.63	7.54	0.88	5.48	7.63	0.72	5.48	7.63	0.72
	20	12.45	5.69	2.19	12.45	5.69	2.19	9.86	6.57	1.50	6.57	7.25	0.91	5.47	7.41	0.74	5.47	7.41	0.74
	25	13.46	4.41	3.05	13.29	4.46	2.98	9.81	5.49	1.79	6.53	6.00	1.09	5.25	6.17	0.85	5.25	6.17	0.85
	30	14.27	3.56	4.01	13.20	3.82	3.45	9.87	4.72	2.09	6.67	5.09	1.31	5.00	5.21	0.96	5.00	5.21	0.96
	35	14.38	3.00	4.80	13.15	3.23	4.08	9.88	3.95	2.50	6.61	4.30	1.54	4.79	4.47	1.07	4.79	4.47	1.07
	40	11.89	2.93	4.05	11.90	2.94	4.05	9.88	3.34	2.96	6.62	3.71	1.79	4.61	3.86	1.20	4.61	3.86	1.20
43	10.34	2.80	3.69	10.34	2.80	3.69	9.91	2.88	3.45	6.62	3.31	2.00	4.45	3.51	1.27	4.45	3.51	1.27	
46	8.05	2.68	3.01	8.05	2.68	3.01	8.05	2.68	3.01	6.59	3.03	2.18	4.26	3.19	1.33	4.26	3.19	1.33	
15	-5	10.12	12.81	0.79	10.12	12.81	0.79	10.12	12.81	0.79	8.90	13.65	0.65	8.90	13.65	0.65	8.90	13.65	0.65
	0	10.25	12.02	0.85	10.25	12.02	0.85	10.25	12.02	0.85	8.91	12.86	0.69	8.91	12.86	0.69	8.91	12.86	0.69
	5	10.54	10.90	0.97	10.54	10.90	0.97	10.27	10.97	0.94	8.89	11.83	0.75	8.89	11.83	0.75	8.89	11.83	0.75
	10	10.63	9.39	1.13	10.63	9.39	1.13	10.36	9.70	1.07	8.19	10.75	0.76	8.19	10.75	0.76	8.19	10.75	0.76
	15	12.14	8.09	1.50	12.14	8.09	1.50	10.18	9.22	1.10	6.87	10.37	0.66	6.39	10.59	0.60	6.39	10.59	0.60
	19	13.94	6.72	2.07	13.48	6.90	1.95	10.26	8.16	1.26	6.80	9.11	0.75	6.28	9.19	0.68	6.28	9.19	0.68
	20	14.02	6.39	2.19	13.58	6.58	2.06	10.16	7.87	1.29	6.75	8.72	0.77	6.22	8.77	0.71	6.22	8.77	0.71
	25	15.09	4.84	3.12	13.59	5.43	2.50	10.16	6.47	1.57	6.93	7.10	0.98	5.95	7.18	0.83	5.95	7.18	0.83
	30	16.05	3.89	4.12	13.63	4.58	2.97	10.31	5.59	1.84	6.89	6.13	1.12	5.69	6.34	0.90	5.69	6.34	0.90
	35	16.03	3.24	4.95	13.61	3.79	3.59	10.19	4.69	2.17	6.80	5.03	1.35	5.39	5.18	1.04	5.39	5.18	1.04
	40	13.31	3.19	4.17	13.31	3.19	4.17	10.25	3.92	2.61	6.89	4.20	1.64	5.11	4.36	1.17	5.11	4.36	1.17
43	11.58	3.05	3.80	11.58	3.05	3.80	10.26	3.51	2.92	6.88	3.70	1.86	4.93	3.87	1.27	4.93	3.87	1.27	
46	9.05	2.93	3.08	9.05	2.93	3.08	9.05	2.93	3.08	6.82	3.32	2.06	4.83	3.59	1.35	4.83	3.59	1.35	

LWT	DB	Maximum			100%(Nonimal)			75%			50%			25%			Minimum		
		CC	EER	PI	CC	EER	PI	CC	EER	PI	CC	EER	PI	CC	EER	PI	CC	EER	PI
18	-5	11.03	13.09	0.84	11.03	13.09	0.84	10.25	13.79	0.74	9.72	14.10	0.69	9.72	14.10	0.69	9.72	14.10	0.69
	0	11.18	12.84	0.87	11.18	12.84	0.87	10.52	13.24	0.79	9.74	13.70	0.71	9.74	13.70	0.71	9.74	13.70	0.71
	5	11.50	12.11	0.95	11.50	12.11	0.95	10.42	12.67	0.82	9.71	13.13	0.74	9.71	13.13	0.74	9.71	13.13	0.74
	10	11.63	11.13	1.05	11.63	11.13	1.05	10.74	11.95	0.90	8.95	12.30	0.73	8.95	12.30	0.73	8.95	12.30	0.73
	15	13.30	8.69	1.53	13.30	8.69	1.53	10.34	10.50	0.98	7.04	11.34	0.62	7.04	11.34	0.62	7.04	11.34	0.62
	19	15.18	7.39	2.05	13.97	7.98	1.75	10.40	9.54	1.09	6.99	10.49	0.67	6.99	10.49	0.67	6.99	10.49	0.67
	20	15.34	6.94	2.21	14.08	7.56	1.86	10.58	9.04	1.17	6.94	10.00	0.69	6.94	10.00	0.69	6.94	10.00	0.69
	25	16.47	5.22	3.16	14.15	6.12	2.31	10.40	7.44	1.40	7.12	8.27	0.86	6.63	8.33	0.80	6.63	8.33	0.80
	30	17.48	4.16	4.21	13.99	5.19	2.70	10.54	6.30	1.67	7.09	6.82	1.04	6.34	6.87	0.92	6.34	6.87	0.92
	35	17.33	3.51	4.94	14.00	4.20	3.33	10.51	5.29	1.98	6.99	5.61	1.25	6.08	5.72	1.06	6.08	5.72	1.06
	40	14.68	3.46	4.24	14.13	3.53	4.00	10.64	4.30	2.47	7.04	4.61	1.53	5.61	5.01	1.12	5.61	5.01	1.12
43	12.60	3.24	3.88	12.60	3.24	3.88	10.27	3.75	2.74	6.87	4.15	1.65	5.50	4.34	1.27	5.50	4.34	1.27	
46	9.88	3.15	3.14	9.88	3.15	3.14	9.88	3.15	3.14	7.00	3.66	1.91	5.31	3.93	1.35	5.31	3.93	1.35	
20	-5	11.58	13.82	0.84	11.58	13.82	0.84	10.59	15.20	0.70	10.31	15.42	0.67	10.31	15.42	0.67	10.31	15.42	0.67
	0	11.83	13.45	0.88	11.83	13.45	0.88	10.52	14.68	0.72	10.32	14.96	0.69	10.32	14.96	0.69	10.32	14.96	0.69
	5	12.19	12.65	0.96	12.19	12.65	0.96	10.74	13.98	0.77	10.29	14.20	0.73	10.29	14.20	0.73	10.29	14.20	0.73
	10	12.33	11.74	1.05	12.33	11.74	1.05	10.51	12.57	0.84	9.49	13.12	0.72	9.49	13.12	0.72	9.49	13.12	0.72
	15	14.07	9.37	1.50	13.81	9.56	1.44	10.67	10.30	1.04	7.47	11.50	0.65	7.47	11.50	0.65	7.47	11.50	0.65
	19	16.08	7.49	2.15	14.27	8.41	1.70	10.45	9.64	1.08	7.42	10.60	0.70	7.42	10.60	0.70	7.42	10.60	0.70
	20	16.17	7.03	2.30	14.13	8.10	1.74	10.65	9.09	1.17	7.39	10.40	0.71	7.39	10.40	0.71	7.39	10.40	0.71
	25	17.38	5.45	3.19	13.96	6.88	2.03	10.44	8.13	1.28	7.07	9.13	0.77	7.07	9.13	0.77	7.07	9.13	0.77
	30	18.42	4.52	4.08	14.12	5.89	2.40	10.66	6.85	1.56	7.21	7.31	0.99	6.80	7.41	0.92	6.80	7.41	0.92
	35	18.33	3.56	5.15	14.06	4.70	2.99	10.60	5.67	1.87	7.00	5.99	1.17	6.48	6.18	1.05	6.48	6.18	1.05
	40	15.25	3.52	4.33	14.08	3.76	3.75	10.55	4.80	2.20	7.07	4.95	1.43	5.96	5.21	1.14	5.96	5.21	1.14
43	13.31	3.38	3.94	13.31	3.38	3.94	10.66	4.32	2.47	7.08	4.43	1.56	5.87	4.65	1.26	5.87	4.65	1.26	
46	10.46	3.30	3.17	10.46	3.30	3.17	10.46	3.30	3.17	7.00	3.93	1.78	5.65	4.18	1.35	5.65	4.18	1.35	
25	-5	12.73	14.42	0.88	12.73	14.42	0.88	11.90	15.49	0.77	11.90	15.49	0.77	11.90	15.49	0.77	11.90	15.49	0.77
	0	12.90	14.01	0.92	12.90	14.01	0.92	11.91	15.11	0.79	11.91	15.11	0.79	11.91	15.11	0.79	11.91	15.11	0.79
	5	13.30	13.42	0.99	13.30	13.42	0.99	11.88	14.47	0.82	11.88	14.47	0.82	11.88	14.47	0.82	11.88	14.47	0.82
	10	13.55	12.24	1.11	13.55	12.24	1.11	10.97	13.39	0.82	10.97	13.39	0.82	10.97	13.39	0.82	10.97	13.39	0.82
	15	15.30	10.26	1.49	13.65	10.93	1.25	10.32	11.88	0.87	8.70	12.26	0.71	8.70	12.26	0.71	8.70	12.26	0.71
	19	17.48	9.03	1.94	14.04	10.16	1.38	10.67	11.06	0.96	8.66	11.26	0.77	8.66	11.26	0.77	8.66	11.26	0.77
	20	17.57	8.52	2.06	13.91	9.52	1.46	10.57	10.47	1.01	8.62	10.70	0.81	8.62	10.70	0.81	8.62	10.70	0.81
	25	18.78	6.08	3.09	13.91	7.97	1.75	10.47	8.72	1.20	8.23	9.25	0.89	8.23	9.25	0.89	8.23	9.25	0.89
	30	19.74	4.70	4.20	14.09	6.93	2.03	10.49	7.74	1.36	7.82	8.21	0.95	7.82	8.21	0.95	7.82	8.21	0.95
	35	19.55	3.82	5.12	14.16	6.01	2.36	10.54	7.07	1.49	7.55	7.52	1.00	7.55	7.52	1.00	7.55	7.52	1.00
	40	16.49	3.87	4.26	14.05	4.86	2.89	10.59	5.85	1.81	6.92	6.72	1.03	6.92	6.72	1.03	6.92	6.72	1.03
43	14.39	3.73	3.86	14.07	4.00	3.52	10.48	4.81	2.18	6.96	5.99	1.16	6.83	6.02	1.13	6.83	6.02	1.13	
46	11.54	3.66	3.15	11.54	3.66	3.15	10.50	4.09	2.57	7.00	4.80	1.46	6.58	4.89	1.35	6.58	4.89	1.35	

Abbreviations:

LWT: Leaving water temperature (°C)

DB: Dry-bulb temperature for Outdoor air temperature (°C)

CC: Total cooling capacity (kW)

PI: Power input (kW)

R290 M thermal Arctic HT Series



16kW Cooling Capacity

LWT	DB	Maximum			100%(Nonimal)			75%			50%			25%			Minimum		
		CC	EER	PI	CC	EER	PI	CC	EER	PI	CC	EER	PI	CC	EER	PI	CC	EER	PI
5	-5	/	/	/	/	/	/	/	/	/	/	/	/	/	/	/	/	/	/
	0	/	/	/	/	/	/	/	/	/	/	/	/	/	/	/	/	/	/
	5	/	/	/	/	/	/	/	/	/	/	/	/	/	/	/	/	/	/
	10	/	/	/	/	/	/	/	/	/	/	/	/	/	/	/	/	/	/
	15	/	/	/	/	/	/	/	/	/	/	/	/	/	/	/	/	/	/
	19	11.00	4.80	2.29	11.00	4.80	2.29	10.48	4.95	2.12	7.01	5.48	1.28	4.46	5.93	0.75	4.46	5.93	0.75
	20	11.22	4.57	2.45	11.22	4.57	2.45	10.56	4.76	2.22	6.95	5.31	1.31	4.44	5.74	0.77	4.44	5.74	0.77
	25	12.16	3.62	3.36	12.16	3.62	3.36	10.54	4.04	2.61	6.98	4.52	1.54	4.27	4.92	0.87	4.27	4.92	0.87
	30	13.12	2.95	4.44	13.12	2.95	4.44	10.54	3.47	3.04	7.07	3.88	1.82	4.12	4.26	0.97	4.12	4.26	0.97
	35	13.41	2.55	5.26	13.41	2.55	5.26	10.46	2.99	3.50	6.92	3.34	2.08	3.90	3.66	1.07	3.90	3.66	1.07
	40	10.48	2.51	4.17	10.48	2.51	4.17	10.48	2.51	4.17	6.98	2.85	2.45	3.71	3.17	1.17	3.71	3.17	1.17
43	9.13	2.39	3.82	9.13	2.39	3.82	9.13	2.39	3.82	7.02	2.64	2.66	3.57	2.89	1.23	3.57	2.89	1.23	
46	7.02	2.28	3.08	7.02	2.28	3.08	7.02	2.28	3.08	7.02	2.28	3.08	3.48	2.67	1.30	3.48	2.67	1.30	
7	-5	/	/	/	/	/	/	/	/	/	/	/	/	/	/	/	/	/	
	0	/	/	/	/	/	/	/	/	/	/	/	/	/	/	/	/	/	/
	5	/	/	/	/	/	/	/	/	/	/	/	/	/	/	/	/	/	/
	10	/	/	/	/	/	/	/	/	/	/	/	/	/	/	/	/	/	/
	15	/	/	/	/	/	/	/	/	/	/	/	/	/	/	/	/	/	/
	19	11.72	5.10	2.30	11.72	5.10	2.30	10.61	5.43	1.95	7.08	5.97	1.19	4.79	6.39	0.75	4.79	6.39	0.75
	20	11.95	4.84	2.47	11.95	4.84	2.47	10.52	5.27	1.99	7.02	5.60	1.25	4.76	6.18	0.77	4.76	6.18	0.77
	25	12.93	3.80	3.40	12.93	3.80	3.40	10.55	4.44	2.38	7.08	4.88	1.45	4.57	5.28	0.87	4.57	5.28	0.87
	30	13.94	3.09	4.52	13.94	3.09	4.52	10.44	3.83	2.73	7.01	4.18	1.68	4.40	4.55	0.97	4.40	4.55	0.97
	35	14.26	2.60	5.48	14.00	2.75	5.09	10.72	3.23	3.32	7.06	3.64	1.94	4.17	3.90	1.07	4.17	3.90	1.07
	40	11.13	2.61	4.26	11.13	2.61	4.26	10.43	2.78	3.74	6.99	3.13	2.23	3.97	3.37	1.18	3.97	3.37	1.18
43	9.71	2.50	3.89	9.71	2.50	3.89	9.71	2.50	3.89	7.09	2.81	2.52	3.82	3.07	1.24	3.82	3.07	1.24	
46	7.48	2.38	3.15	7.48	2.38	3.15	7.48	2.38	3.15	7.00	2.43	2.89	3.72	2.83	1.31	3.72	2.83	1.31	
10	-5	/	/	/	/	/	/	/	/	/	/	/	/	/	/	/	/	/	
	0	/	/	/	/	/	/	/	/	/	/	/	/	/	/	/	/	/	/
	5	/	/	/	/	/	/	/	/	/	/	/	/	/	/	/	/	/	/
	10	/	/	/	/	/	/	/	/	/	/	/	/	/	/	/	/	/	/
	15	11.32	6.79	1.67	11.32	6.79	1.67	10.90	7.13	1.53	7.16	7.78	0.92	5.41	8.37	0.65	5.41	8.37	0.65
	19	12.86	5.57	2.31	12.86	5.57	2.31	11.05	6.21	1.78	7.36	7.03	1.05	5.33	7.37	0.72	5.33	7.37	0.72
	20	13.12	5.28	2.49	13.12	5.28	2.49	10.95	6.01	1.82	7.29	6.65	1.10	5.29	7.10	0.74	5.29	7.10	0.74
	25	14.16	4.10	3.46	14.16	4.10	3.46	11.02	4.89	2.25	7.38	5.53	1.34	5.05	5.89	0.86	5.05	5.89	0.86
	30	15.23	3.29	4.62	14.50	3.45	4.20	10.94	4.28	2.56	7.33	4.64	1.58	4.85	5.04	0.96	4.85	5.04	0.96
	35	15.55	2.76	5.63	14.61	2.89	5.06	11.03	3.59	3.07	7.40	4.02	1.84	4.60	4.29	1.07	4.60	4.29	1.07
	40	12.23	2.73	4.48	12.23	2.73	4.48	11.10	3.01	3.68	7.33	3.42	2.14	4.38	3.69	1.19	4.38	3.69	1.19
43	10.67	2.69	3.97	10.67	2.69	3.97	10.67	2.69	3.97	7.31	3.06	2.39	4.22	3.35	1.26	4.22	3.35	1.26	
46	8.24	2.55	3.23	8.24	2.55	3.23	8.24	2.55	3.23	7.27	2.79	2.60	4.12	3.10	1.33	4.12	3.10	1.33	
11	-5	/	/	/	/	/	/	/	/	/	/	/	/	/	/	/	/	/	
	0	/	/	/	/	/	/	/	/	/	/	/	/	/	/	/	/	/	/
	5	/	/	/	/	/	/	/	/	/	/	/	/	/	/	/	/	/	/
	10	10.22	8.84	1.16	10.22	8.84	1.16	9.86	8.94	1.10	7.67	9.69	0.79	7.23	9.99	0.72	7.23	9.99	0.72
	15	11.67	7.00	1.67	11.67	7.00	1.67	10.83	7.18	1.51	7.38	8.08	0.91	5.60	8.76	0.64	5.60	8.76	0.64
	19	13.26	5.74	2.31	13.26	5.74	2.31	11.19	6.51	1.72	7.32	7.20	1.02	5.48	7.63	0.72	5.48	7.63	0.72
	20	13.52	5.43	2.49	13.52	5.43	2.49	11.09	6.30	1.76	7.53	6.91	1.09	5.47	7.41	0.74	5.47	7.41	0.74
	25	14.58	4.19	3.48	14.58	4.19	3.48	11.17	5.21	2.15	7.40	5.80	1.28	5.25	6.17	0.85	5.25	6.17	0.85
	30	15.68	3.37	4.66	14.78	3.47	4.26	11.09	4.44	2.50	7.36	4.87	1.51	5.00	5.21	0.96	5.00	5.21	0.96
	35	15.99	2.81	5.69	14.90	2.93	5.09	11.04	3.76	2.94	7.44	4.15	1.79	4.79	4.47	1.07	4.79	4.47	1.07
	40	12.64	2.78	4.55	12.64	2.78	4.55	11.19	3.17	3.53	7.41	3.54	2.09	4.61	3.86	1.20	4.61	3.86	1.20
43	10.99	2.74	4.01	10.99	2.74	4.01	10.99	2.74	4.01	7.37	3.17	2.33	4.45	3.51	1.27	4.45	3.51	1.27	
46	8.51	2.60	3.27	8.51	2.60	3.27	8.51	2.60	3.27	7.36	2.92	2.52	4.26	3.19	1.33	4.26	3.19	1.33	
15	-5	10.45	12.55	0.83	10.45	12.55	0.83	10.45	12.55	0.83	8.90	13.65	0.65	8.90	13.65	0.65	8.90	13.65	0.65
	0	10.50	11.74	0.89	10.50	11.74	0.89	10.50	11.74	0.89	8.91	12.86	0.69	8.91	12.86	0.69	8.91	12.86	0.69
	5	10.81	10.66	1.01	10.81	10.66	1.01	10.81	10.66	1.01	8.89	11.83	0.75	8.89	11.83	0.75	8.89	11.83	0.75
	10	11.46	9.04	1.27	11.46	9.04	1.27	10.76	9.34	1.15	8.52	10.46	0.81	8.19	10.75	0.76	8.19	10.75	0.76
	15	13.11	7.97	1.64	13.11	7.97	1.64	11.45	8.61	1.33	7.58	10.06	0.75	6.39	10.59	0.60	6.39	10.59	0.60
	19	14.94	6.46	2.31	14.94	6.46	2.31	11.64	7.90	1.47	7.82	8.95	0.87	6.28	9.19	0.68	6.28	9.19	0.68
	20	15.19	6.09	2.49	15.19	6.09	2.49	11.59	7.68	1.51	7.76	8.58	0.90	6.22	8.77	0.71	6.22	8.77	0.71
	25	16.41	4.62	3.55	15.43	4.88	3.16	11.73	6.20	1.89	7.64	6.98	1.09	5.95	7.18	0.83	5.95	7.18	0.83
	30	17.63	3.68	4.80	15.43	4.21	3.66	11.74	5.24	2.24	7.90	5.91	1.34	5.69	6.34	0.90	5.69	6.34	0.90
	35	17.42	3.07	5.68	15.45	3.50	4.41	11.72	4.36	2.69	7.77	4.90	1.59	5.39	5.18	1.04	5.39	5.18	1.04
	40	14.12	3.14	4.50	14.12	3.14	4.50	11.63	3.65	3.19	7.78	4.10	1.90	5.11	4.36	1.17	5.11	4.36	1.17
43	12.33	3.00	4.12	12.33	3.00	4.12	11.74	3.25	3.62	7.73	3.60	2.15	4.93	3.87	1.27	4.93	3.87	1.27	
46	9.56	2.89	3.31	9.56	2.89	3.31	9.56	2.89	3.31	7.73	3.25	2.38	4.83	3.59	1.35	4.83	3.59	1.35	

LWT	DB	Maximum			100%(Nonimal)			75%			50%			25%			Minimum		
		CC	EER	PI	CC	EER	PI	CC	EER	PI	CC	EER	PI	CC	EER	PI	CC	EER	PI
18	-5	11.10	13.06	0.85	11.10	13.06	0.85	11.10	13.06	0.85	9.72	14.10	0.69	9.72	14.10	0.69	9.72	14.10	0.69
	0	11.44	12.66	0.90	11.44	12.66	0.90	11.44	12.66	0.90	9.74	13.70	0.71	9.74	13.70	0.71	9.74	13.70	0.71
	5	11.79	12.02	0.98	11.79	12.02	0.98	11.79	12.02	0.98	9.71	13.13	0.74	9.71	13.13	0.74	9.71	13.13	0.74
	10	12.30	10.91	1.13	12.30	10.91	1.13	11.45	11.46	1.00	9.25	12.11	0.76	8.95	12.30	0.73	8.95	12.30	0.73
	15	14.30	8.45	1.69	14.30	8.45	1.69	11.91	10.01	1.19	8.04	10.86	0.74	7.04	11.34	0.62	7.04	11.34	0.62
	19	16.28	7.11	2.29	16.04	7.21	2.22	11.97	9.21	1.30	8.03	10.38	0.77	6.99	10.49	0.67	6.99	10.49	0.67
	20	16.58	6.61	2.51	16.12	6.80	2.37	11.96	8.51	1.41	7.96	9.80	0.81	6.94	10.00	0.69	6.94	10.00	0.69
	25	17.81	4.93	3.61	16.04	5.57	2.88	12.14	7.19	1.69	8.11	8.09	1.00	6.63	8.33	0.80	6.63	8.33	0.80
	30	19.18	3.91	4.90	16.00	4.72	3.39	12.13	5.97	2.03	8.12	6.72	1.21	6.34	6.87	0.92	6.34	6.87	0.92
	35	18.64	3.32	5.62	16.00	3.90	4.10	12.15	4.90	2.48	7.99	5.50	1.45	6.08	5.72	1.06	6.08	5.72	1.06
	40	15.34	3.34	4.59	15.34	3.34	4.59	12.17	4.10	2.97	8.06	4.47	1.80	5.61	5.01	1.12	5.61	5.01	1.12
43	13.42	3.10	4.33	13.42	3.10	4.33	12.09	3.50	3.45	8.04	4.01	2.00	5.50	4.34	1.27	5.50	4.34	1.27	
46	10.43	2.99	3.49	10.43	2.99	3.49	10.43	2.99	3.49	8.00	3.57	2.24	5.31	3.93	1.35	5.31	3.93	1.35	
20	-5	11.73	13.53	0.87	11.73	13.53	0.87	11.73	13.51	0.87	10.31	15.42	0.67	10.31	15.42	0.67	10.31	15.42	0.67
	0	12.10	13.22	0.92	12.10	13.22	0.92	12.10	13.21	0.92	10.32	14.96	0.69	10.32	14.96	0.69	10.32	14.96	0.69
	5	12.49	12.65	0.99	12.49	12.65	0.99	12.09	12.75	0.95	10.29	14.20	0.73	10.29	14.20	0.73	10.29	14.20	0.73
	10	13.03	11.38	1.15	13.03	11.38	1.15	12.02	11.76	1.02	9.49	13.12	0.72	9.49	13.12	0.72	9.49	13.12	0.72
	15	15.21	9.02	1.69	15.21	9.02	1.69	12.12	10.04	1.21	8.00	11.04	0.72	7.47	11.50	0.65	7.47	11.50	0.65
	19	17.23	7.19	2.40	15.96	7.70	2.07	12.23	9.31	1.31	7.96	10.44	0.76	7.42	10.60	0.70	7.42	10.60	0.70
	20	17.53	6.63	2.64	16.06	7.31	2.20	12.12	8.78	1.38	8.16	10.08	0.81	7.39	10.40	0.71	7.39	10.40	0.71
	25	18.77	5.15	3.65	16.30	6.20	2.63	12.09	7.58	1.59	8.08	8.90	0.91	7.07	9.13	0.77	7.07	9.13	0.77
	30	20.11	4.04	4.98	16.17	5.29	3.06	12.06	6.59	1.83	8.08	7.02	1.15	6.80	7.41	0.92	6.80	7.41	0.92
	35	19.54	3.42	5.72	16.06	4.29	3.74	11.91	5.46	2.18	7.98	5.86	1.36	6.48	6.18	1.05	6.48	6.18	1.05
	40	16.22	3.36	4.82	16.05	3.36	4.77	12.00	4.32	2.78	8.09	4.80	1.68	5.96	5.21	1.14	5.96	5.21	1.14
43	14.18	3.33	4.26	14.18	3.33	4.26	12.02	4.03	2.98	8.08	4.07	1.98	5.87	4.65	1.26	5.87	4.65	1.26	
46	10.97	3.22	3.41	10.97	3.22	3.41	10.97	3.22	3.41	8.00	3.76	2.13	5.65	4.18	1.35	5.65	4.18	1.35	
25	-5	12.86	13.97	0.92	12.86	13.97	0.92	12.86	13.97	0.92	11.90	15.49	0.77	11.90	15.49	0.77	11.90	15.49	0.77
	0	13.18	13.51	0.98	13.18	13.51	0.98	13.18	13.51	0.98	11.91	15.11	0.79	11.91	15.11	0.79	11.91	15.11	0.79
	5	13.61	12.97	1.05	13.61	12.97	1.05	12.88	13.50	0.82	11.88	14.47	0.82	11.88	14.47	0.82	11.88	14.47	0.82
	10	14.26	11.90	1.20	14.26	11.90	1.20	11.82	12.43	0.95	10.97	13.39	0.82	10.97	13.39	0.82	10.97	13.39	0.82
	15	16.62	9.82	1.69	15.82	10.16	1.56	11.99	11.34	1.06	8.70	12.26	0.71	8.70	12.26	0.71	8.70	12.26	0.71
	19	18.72	8.62	2.17	16.23	9.36	1.73	12.13	10.30	1.18	8.66	11.26	0.77	8.66	11.26	0.77	8.66	11.26	0.77
	20	19.02	7.98	2.38	16.08	8.97	1.79	12.02	9.79	1.23	8.62	10.70	0.81	8.62	10.70	0.81	8.62	10.70	0.81
	25	20.27	5.72	3.54	16.17	7.34	2.20	12.15	8.26	1.47	8.23	9.25	0.89	8.23	9.25	0.89	8.23	9.25	0.89
	30	21.60	4.40	4.91	16.15	6.29	2.57	12.13	7.48	1.62	7.96	8.15	0.98	7.82	8.21	0.95	7.82	8.21	0.95
	35	20.92	3.69	5.66	16.09	5.51	2.92	12.08	6.76	1.79	7.87	7.48	1.05	7.55	7.52	1.00	7.55	7.52	1.00
	40	17.54	3.58	4.89	16.06	4.45	3.61	12.04	5.63	2.14	8.02	6.14	1.31	6.92	6.72	1.03	6.92	6.72	1.03
43	15.34	3.68	4.17	15.34	3.68	4.17	12.11	4.50	2.69	8.04	5.56	1.45	6.83	6.02	1.13	6.83	6.02	1.13	
46	12.06	3.42	3.53	12.06	3.42	3.53	12.00	3.60	3.33	8.00	4.61	1.74	6.58	4.89	1.35	6.58	4.89	1.35	

Abbreviations:

LWT: Leaving water temperature (°C)

DB: Dry-bulb temperature for Outdoor air temperature (°C)

CC: Total cooling capacity (kW)

PI: Power input (kW)

7 Sound Levels

7.1 Overall

Sound pressure levels¹

Model name	dB(A) ²
MHC-V4WD2N7	44
MHC-V6WD2N7	46
MHC-V8WD2N7	48
MHC-V10WD2N7	49
MHC-V12WD2N7	51
MHC-V14WD2N7	52
MHC-V16WD2N7	56
MHC-V12WD2RN7	51
MHC-V14WD2RN7	52
MHC-V16WD2RN7	56

Notes:

1. Sound pressure level is measured at a position 1m in front of the unit and $(1+H)/2$ m (where H is the height of the unit) above the floor in a semi-anechoic chamber. During on-site operation, sound pressure levels may be higher as a result of ambient noise.

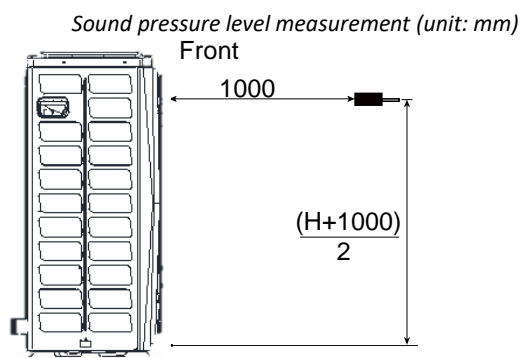

2. dB(A) is the maximum value tested under the conditions below:
Outdoor air temperature 7°C DB, 85% R.H.; EWT 30°C, LWT 35°C. Free compressor frequency.

7.2 Octave Band Levels

We measure noise of the unit from 4 sides as below, with a rated frequency at the distance of 1m.



The conditions we've tested is illustrated as below:

Heating A-7W35: Evaporator air in -7°C , 85% R.H., Condenser water in/out $30/35^{\circ}\text{C}$

Heating A7W35: Evaporator air in 7°C , 85% R.H., Condenser water in/out $30/35^{\circ}\text{C}$

Heating A7W45: Evaporator air in 7°C , 85% R.H., Condenser water in/out $40/45^{\circ}\text{C}$

Heating A7W55: Evaporator air in 7°C , 85% R.H., Condenser water in/out $47/55^{\circ}\text{C}$

Cooling A35W18: Condenser air in 35°C . Evaporator water in/out $23/18^{\circ}\text{C}$

Cooling A35W7: Condenser air in 35°C . Evaporator water in/out $12/7^{\circ}\text{C}$

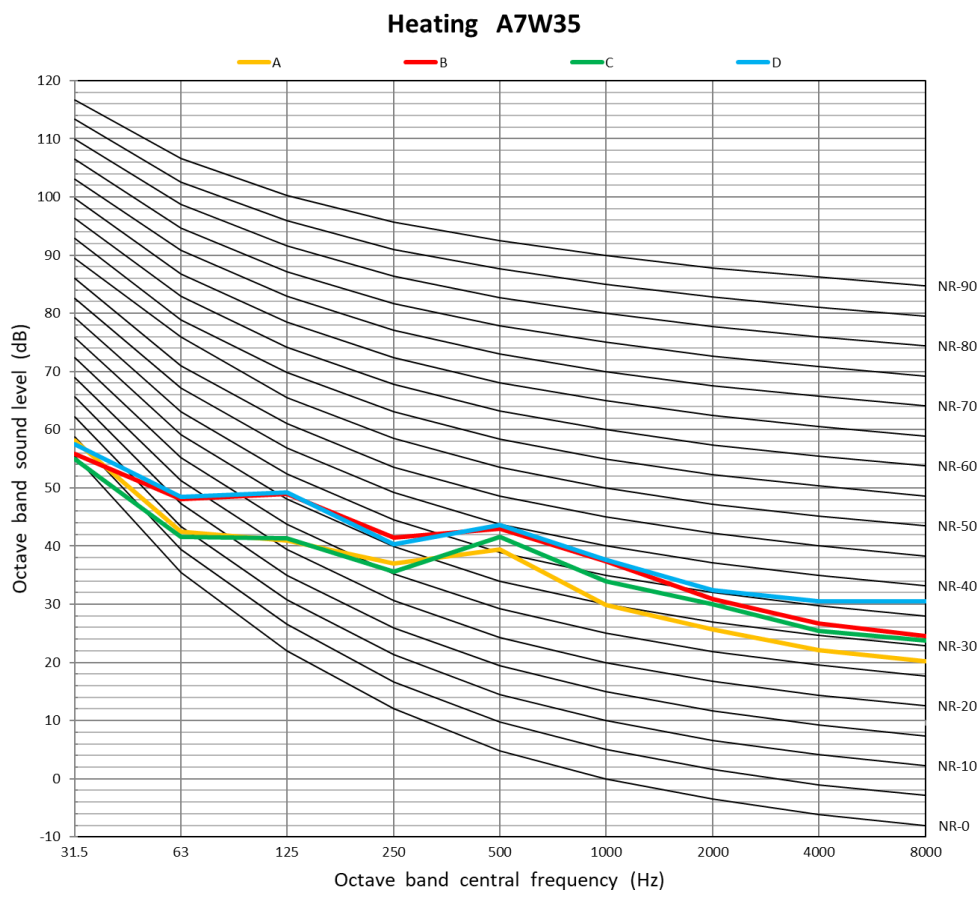
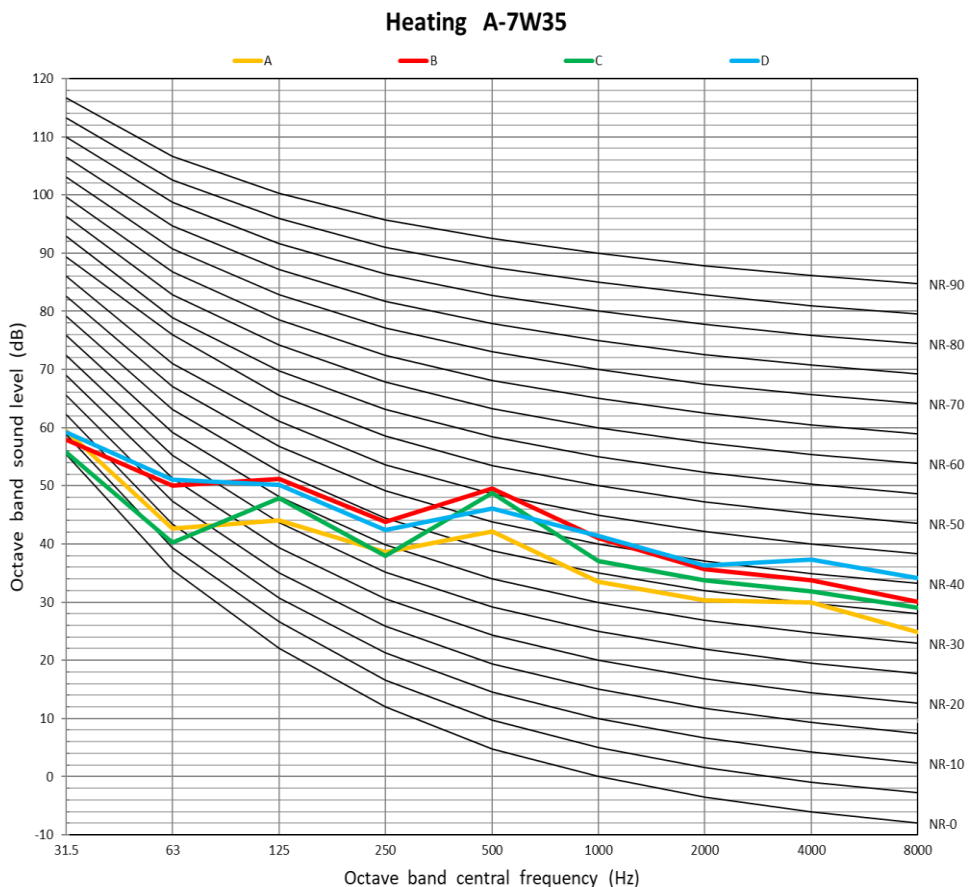

4kW

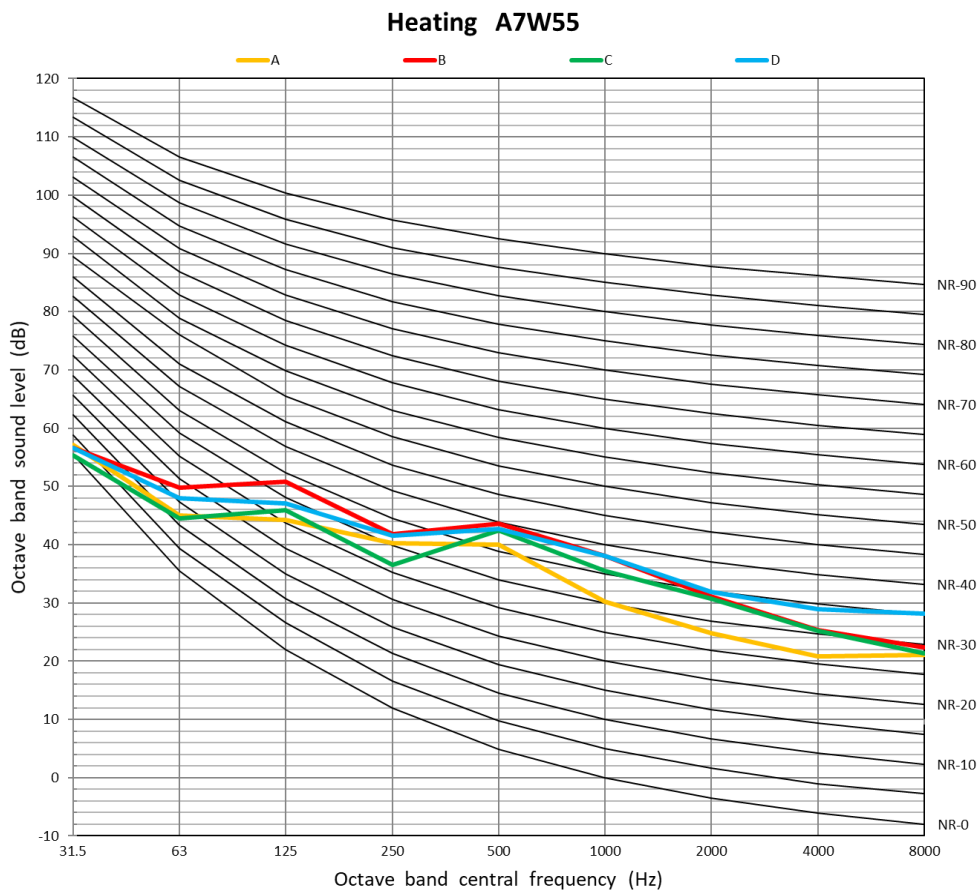
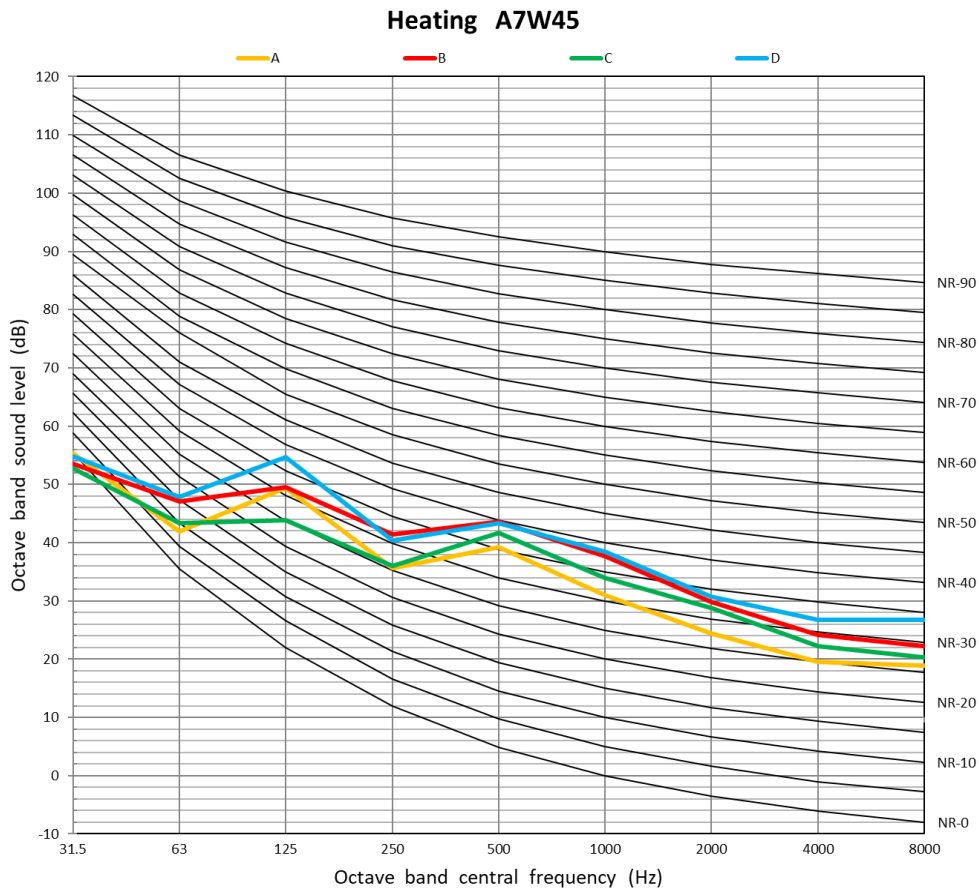

4kW

Midea R290 M thermal Arctic HT Series Engineering Data Book

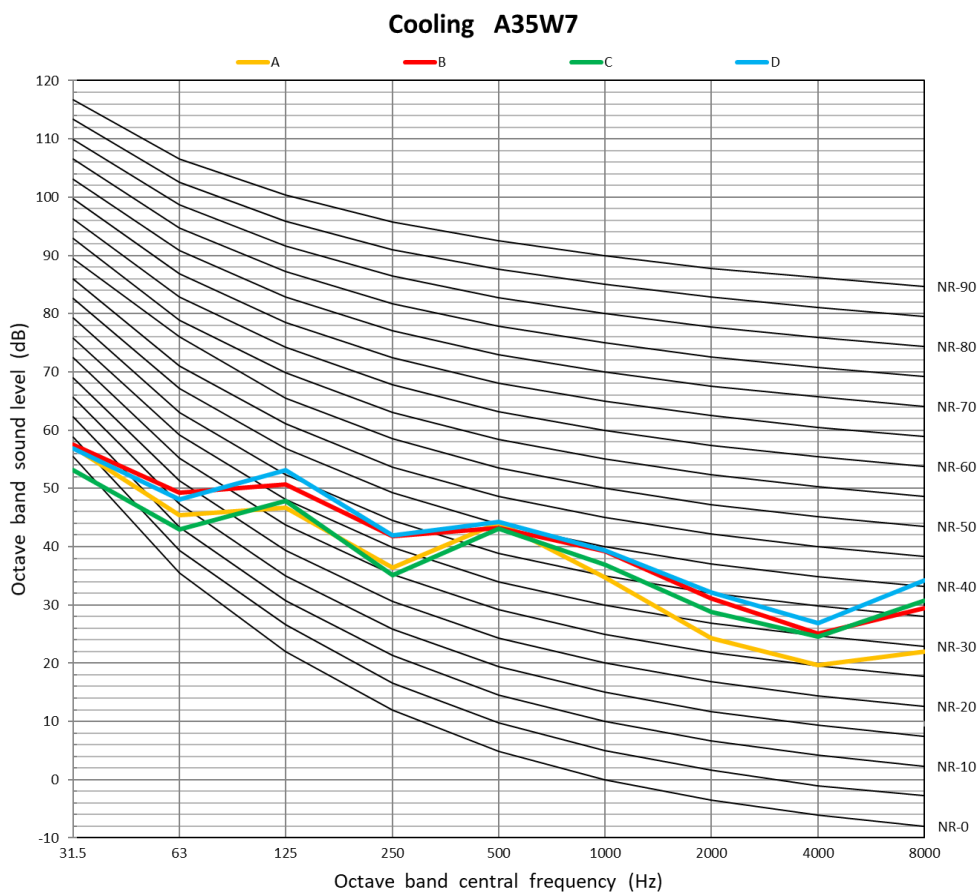
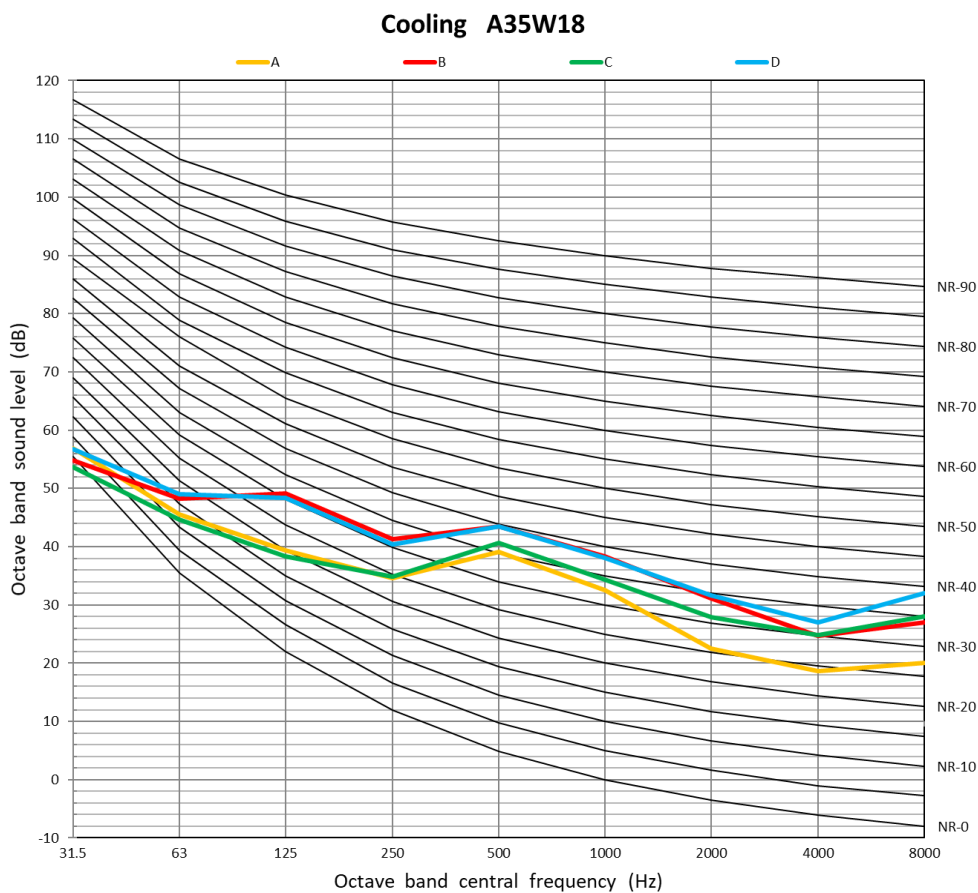

7.2.2 6kW

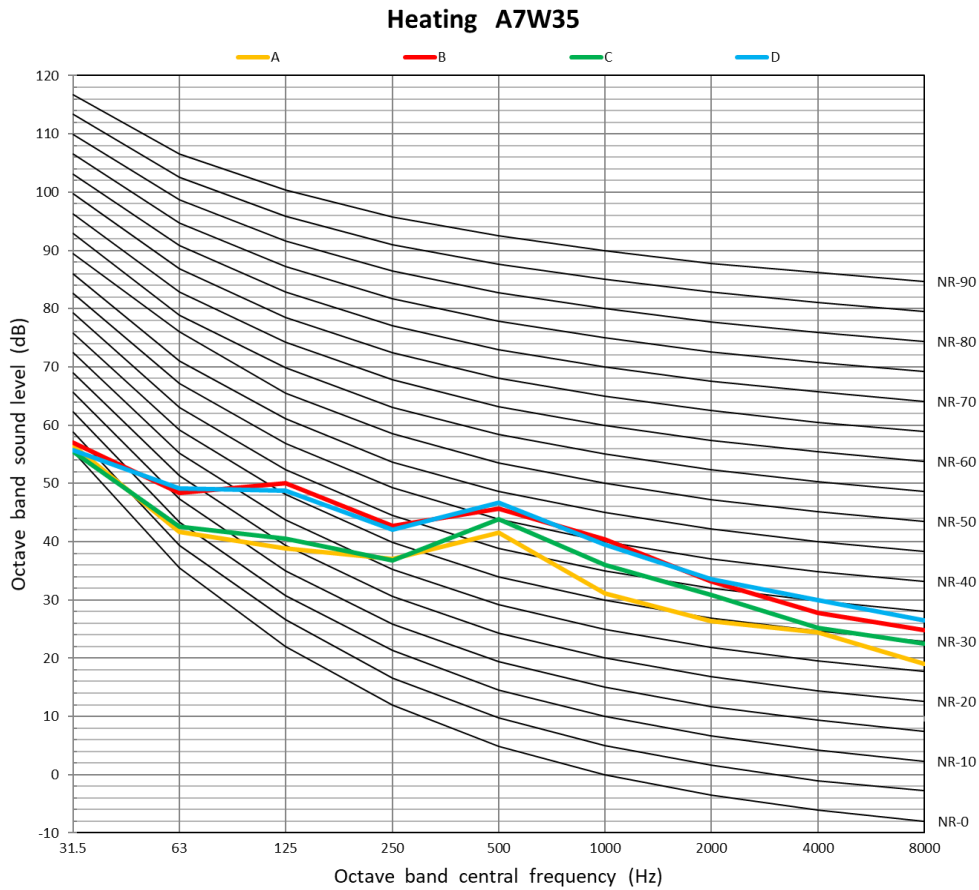
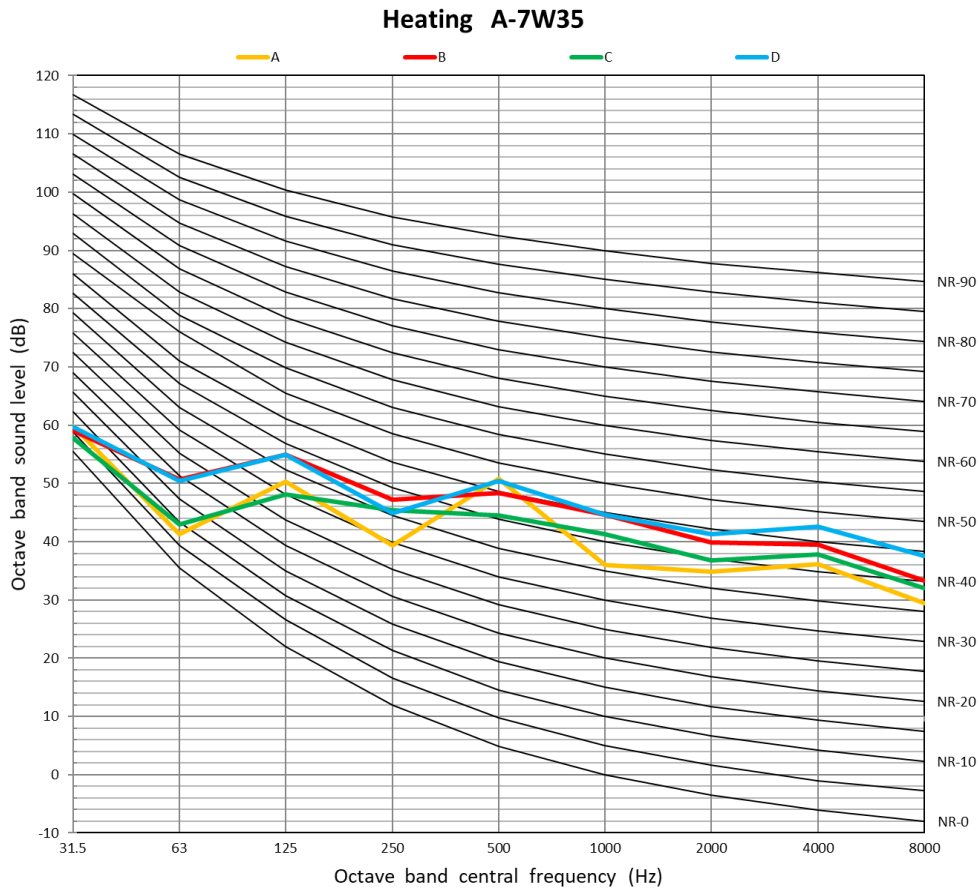

6kW

Midea R290 M thermal Arctic HT Series Engineering Data Book

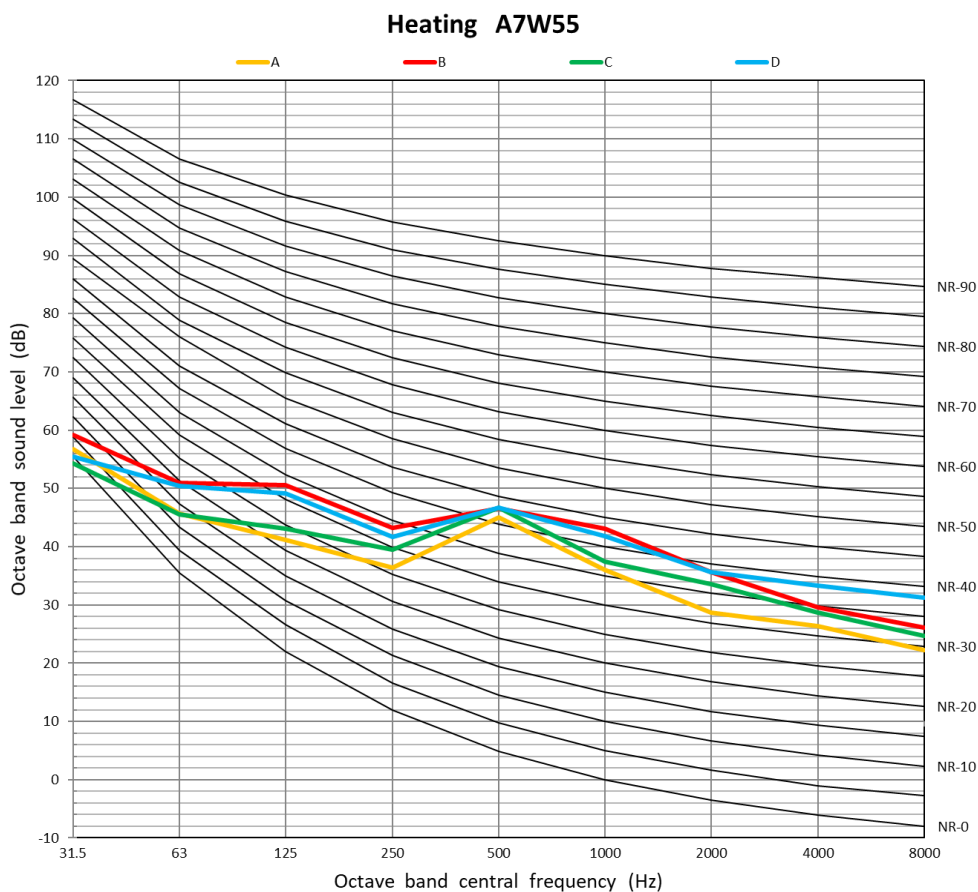
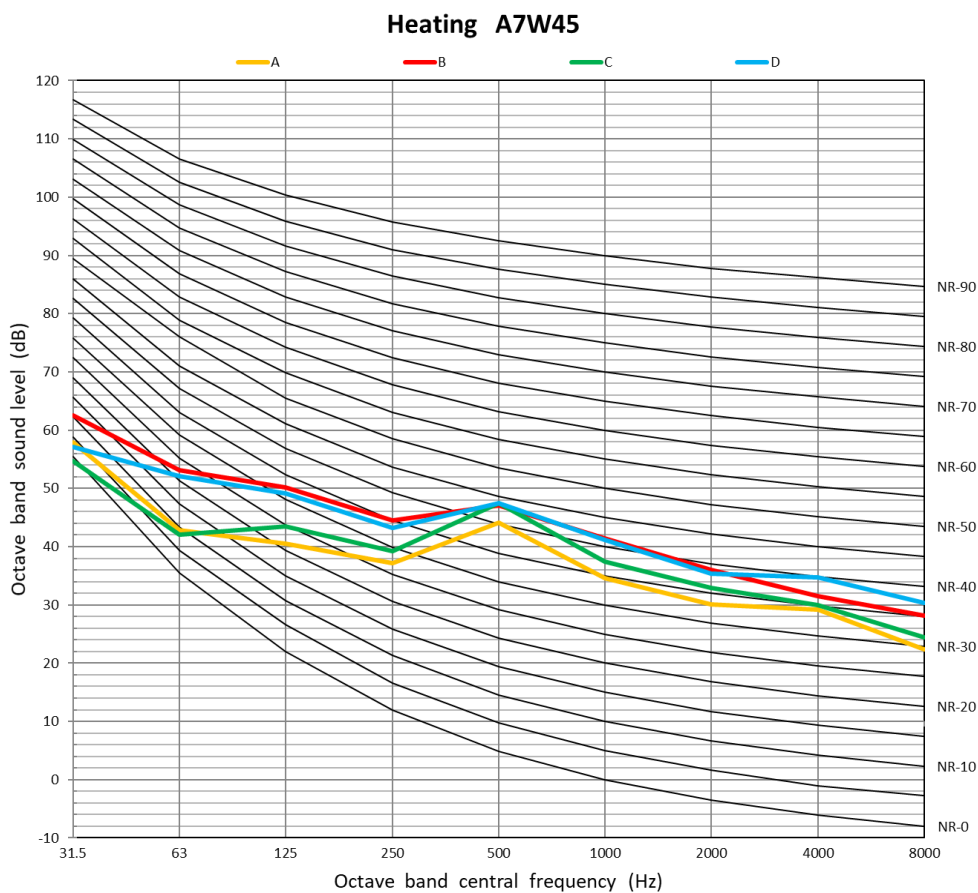

6kW

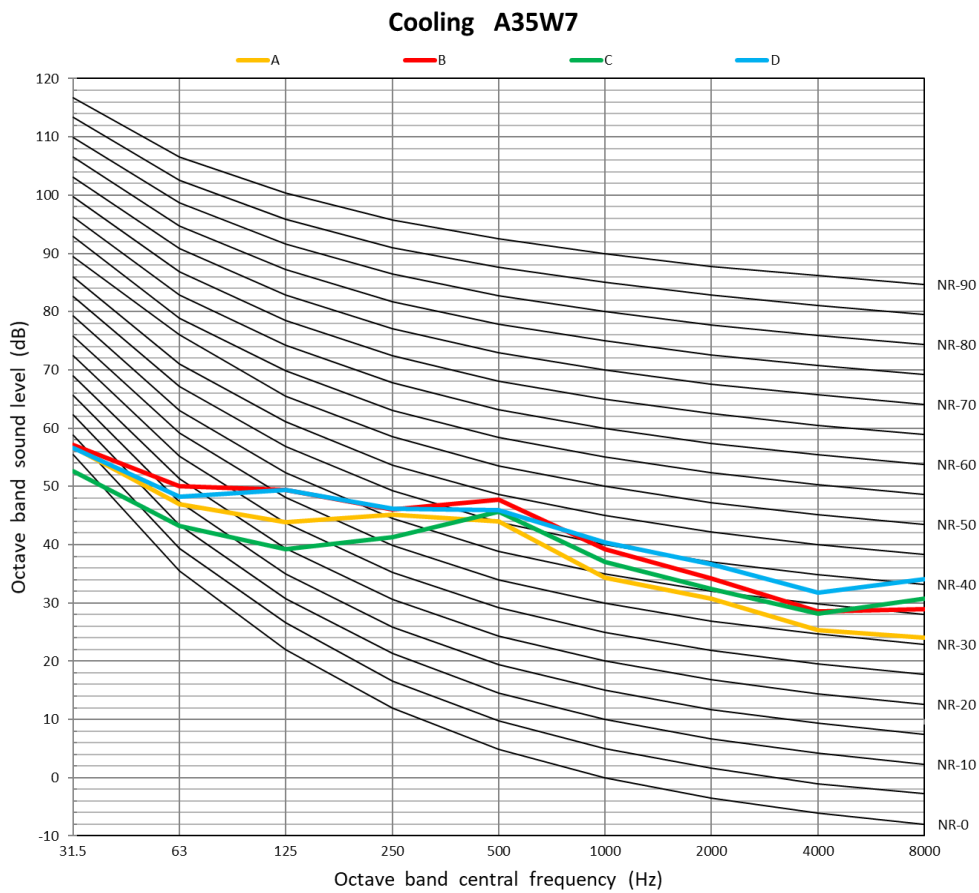
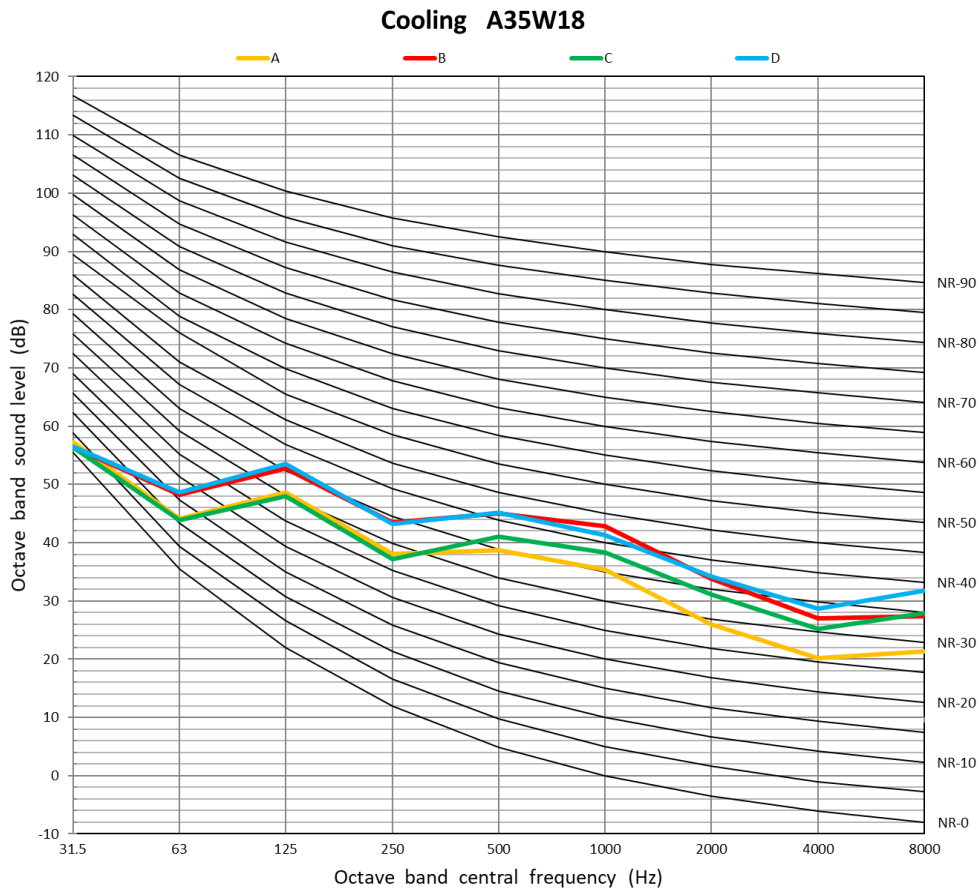

7.2.3 8kW

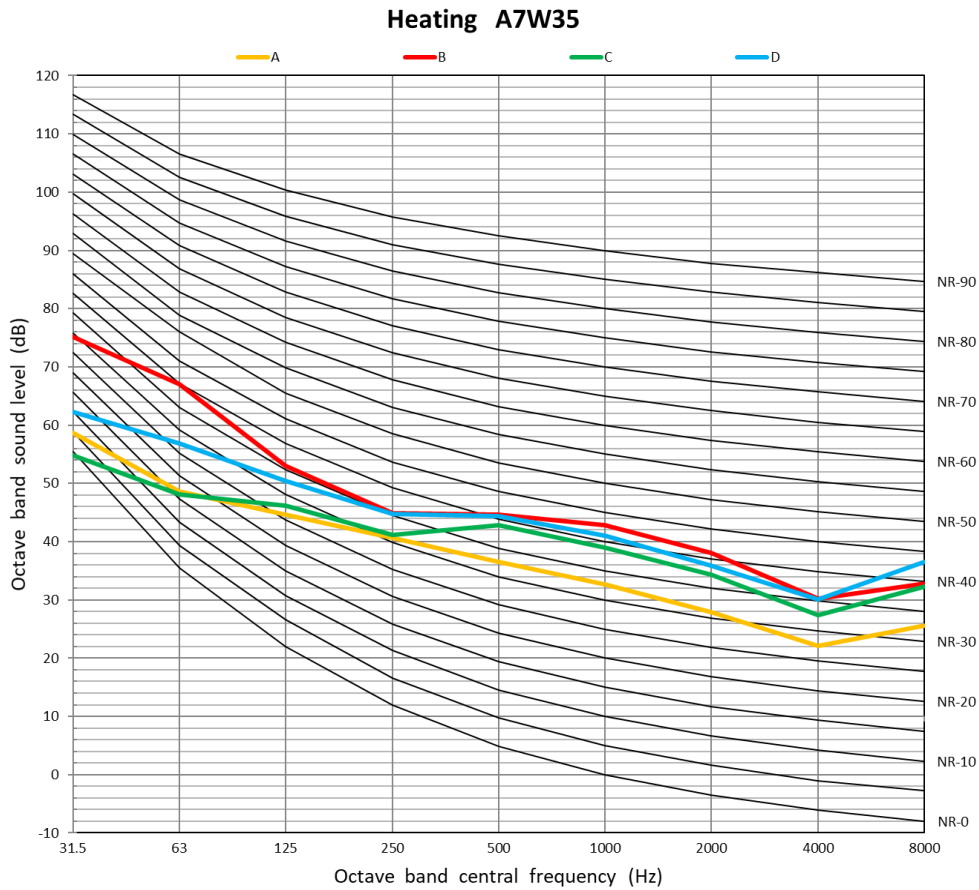
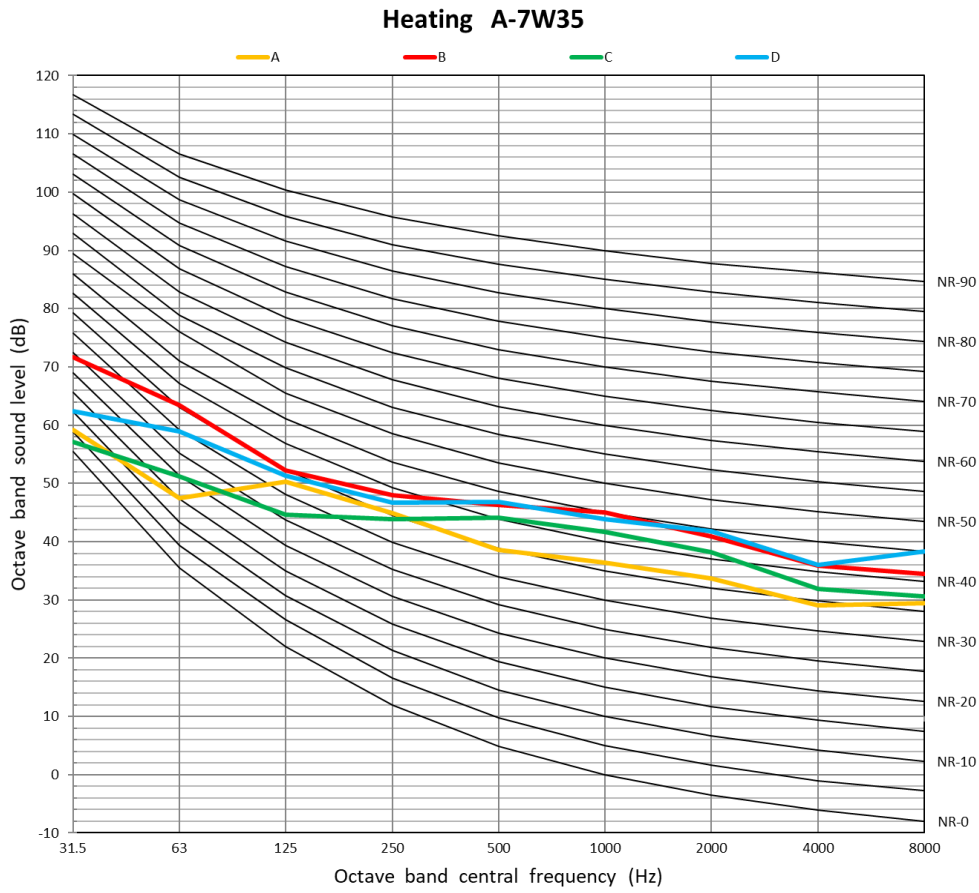

8kW

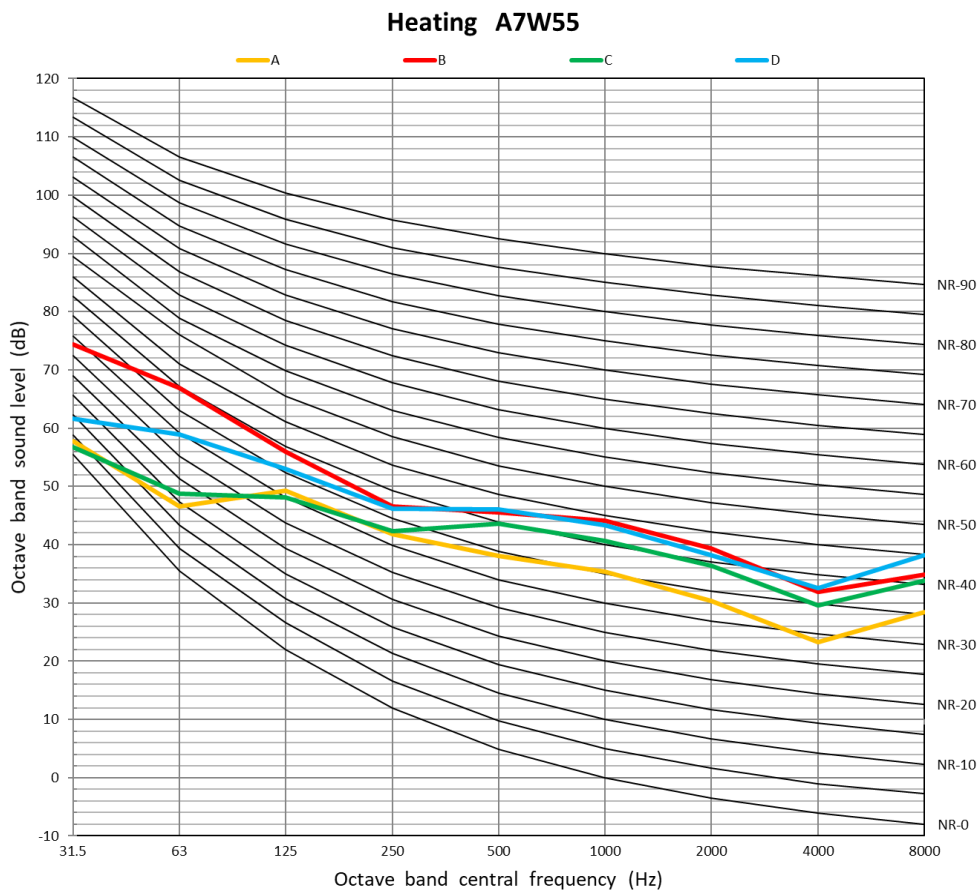
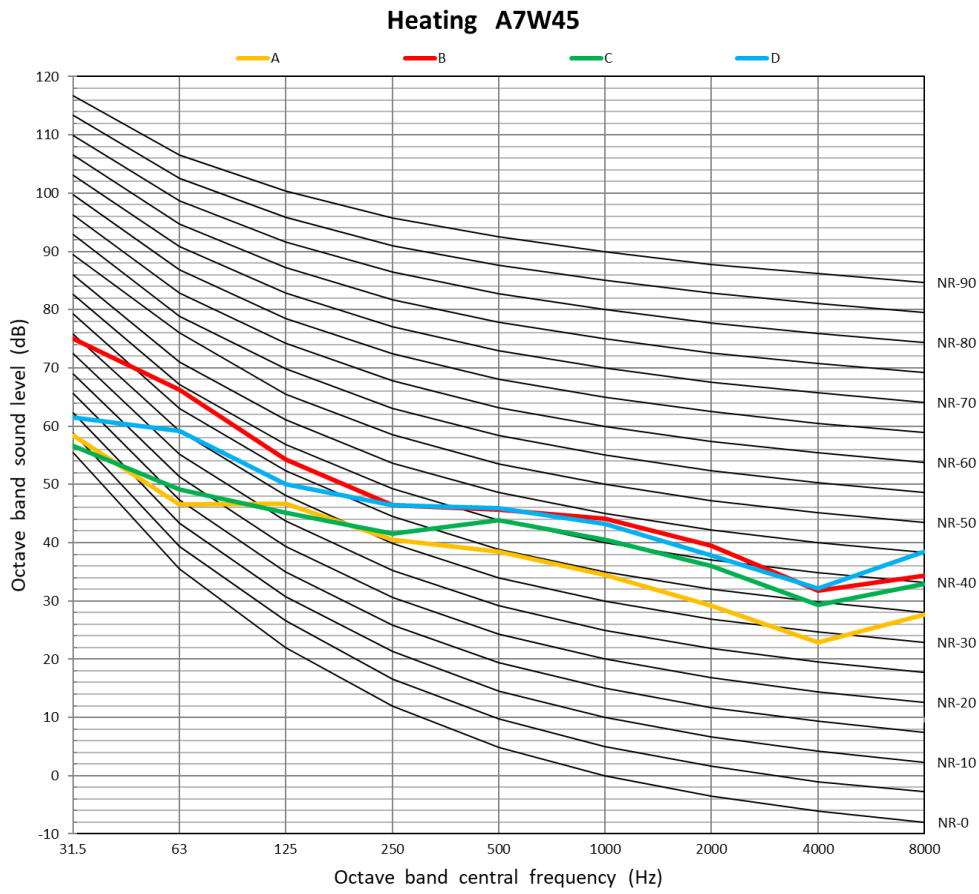

8kW

Midea R290 M thermal Arctic HT Series Engineering Data Book

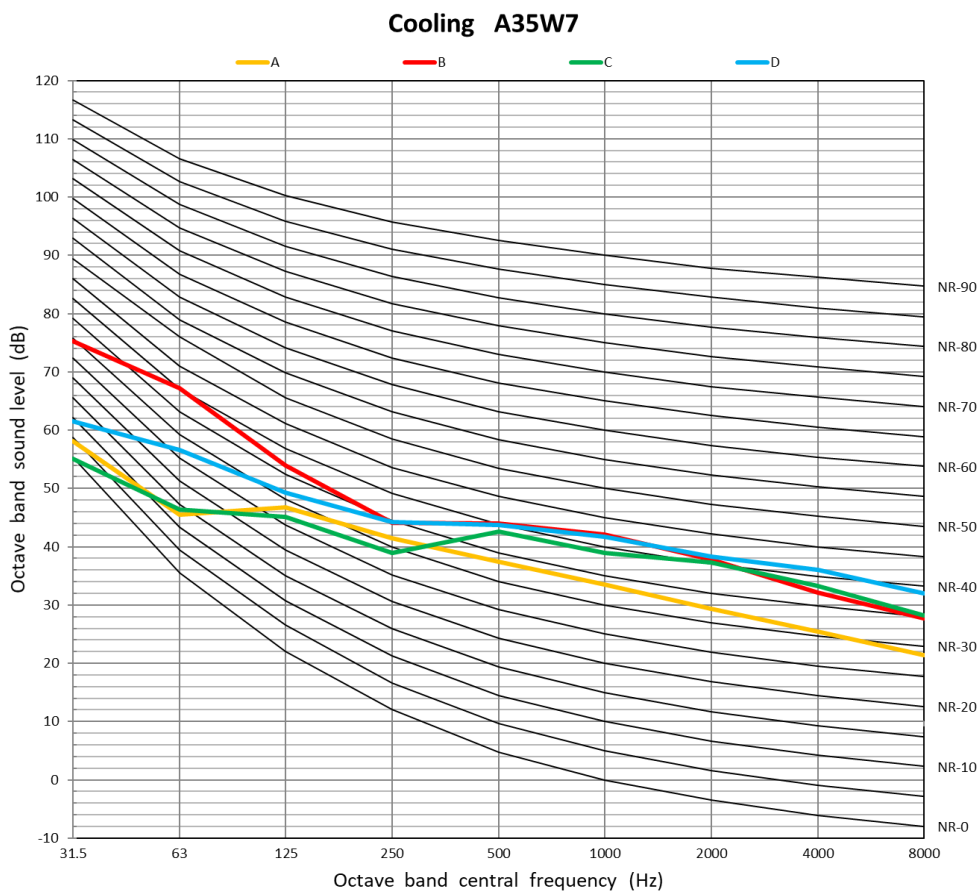
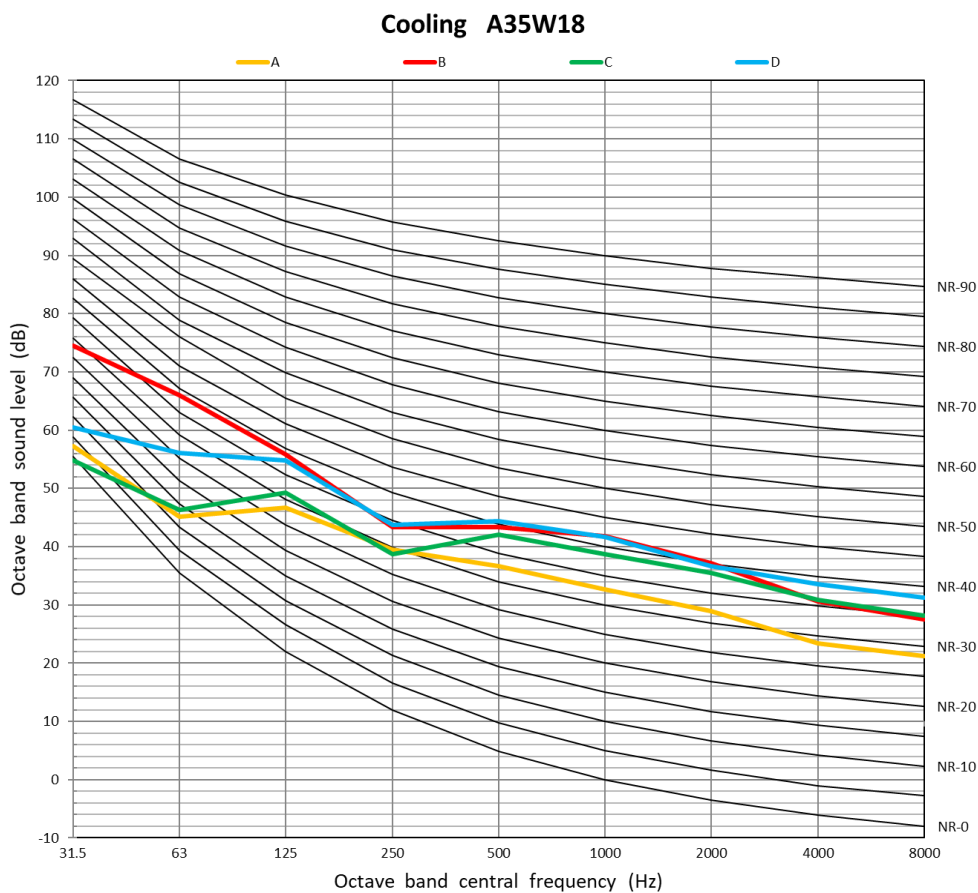

7.2.4 10kW

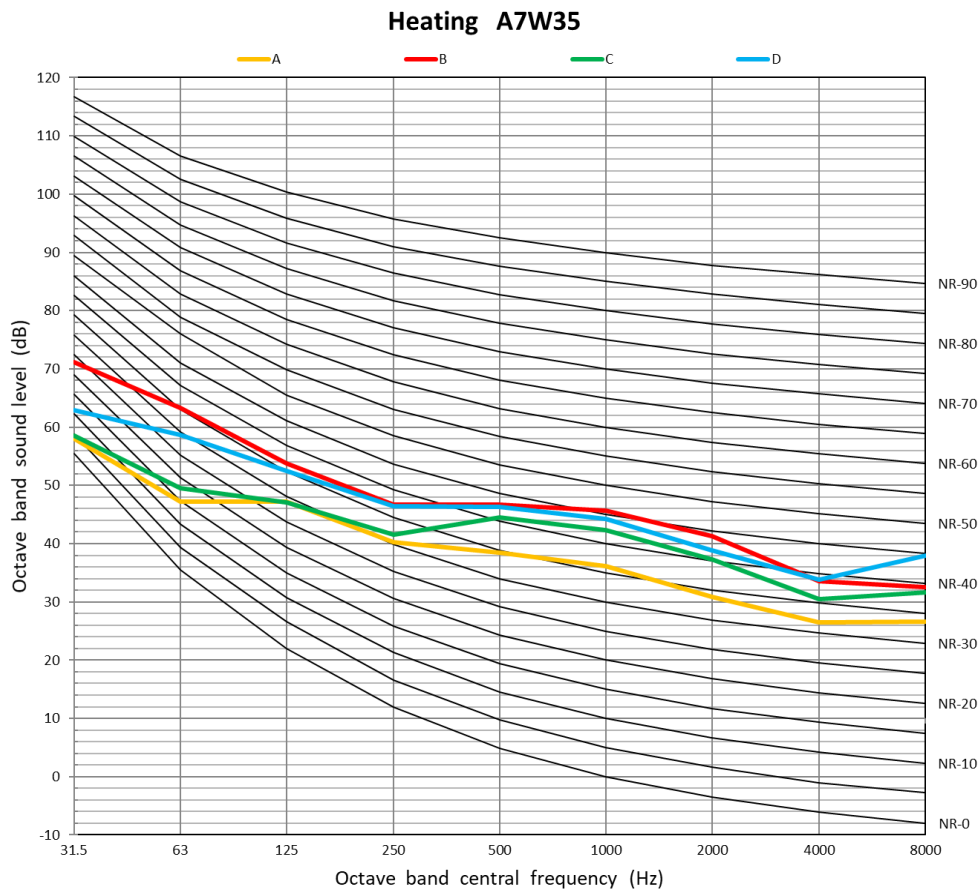
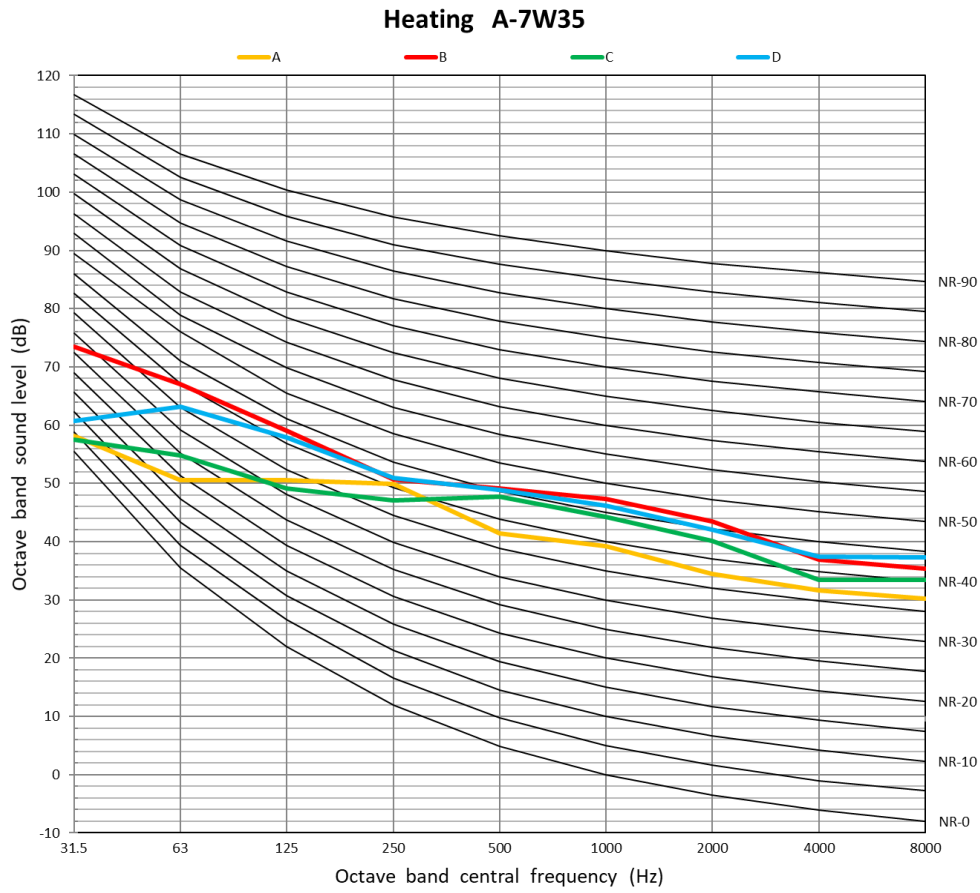

10kW

Midea R290 M thermal Arctic HT Series Engineering Data Book

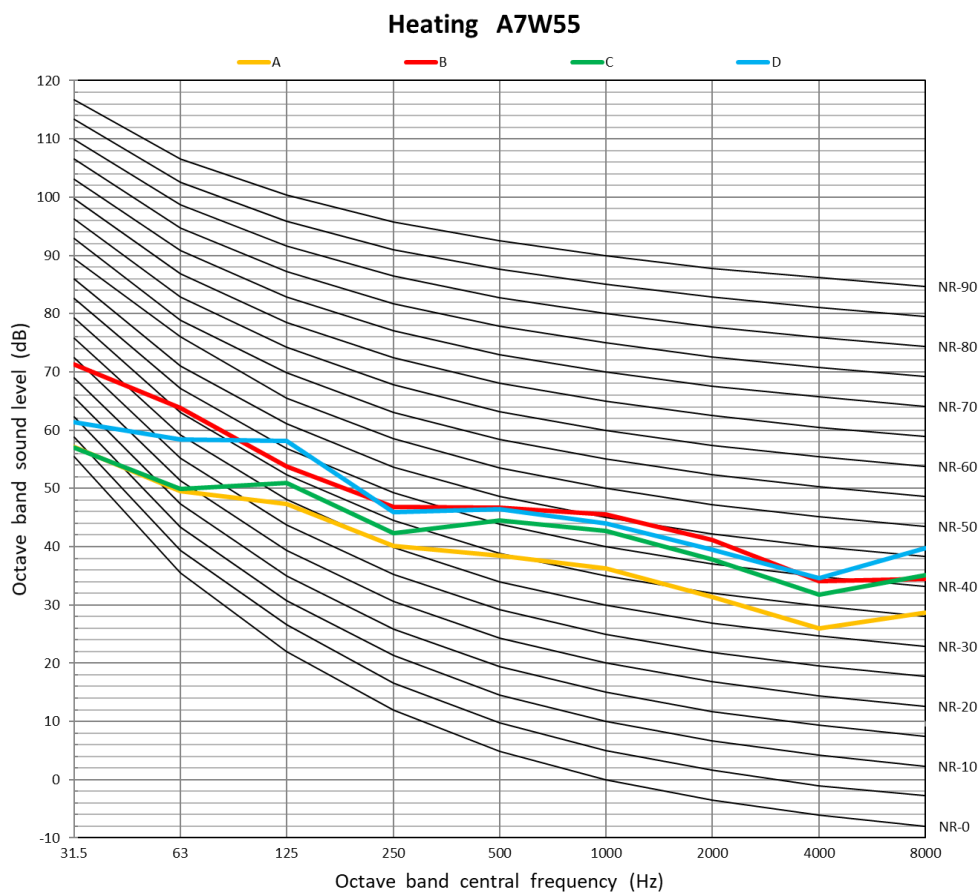
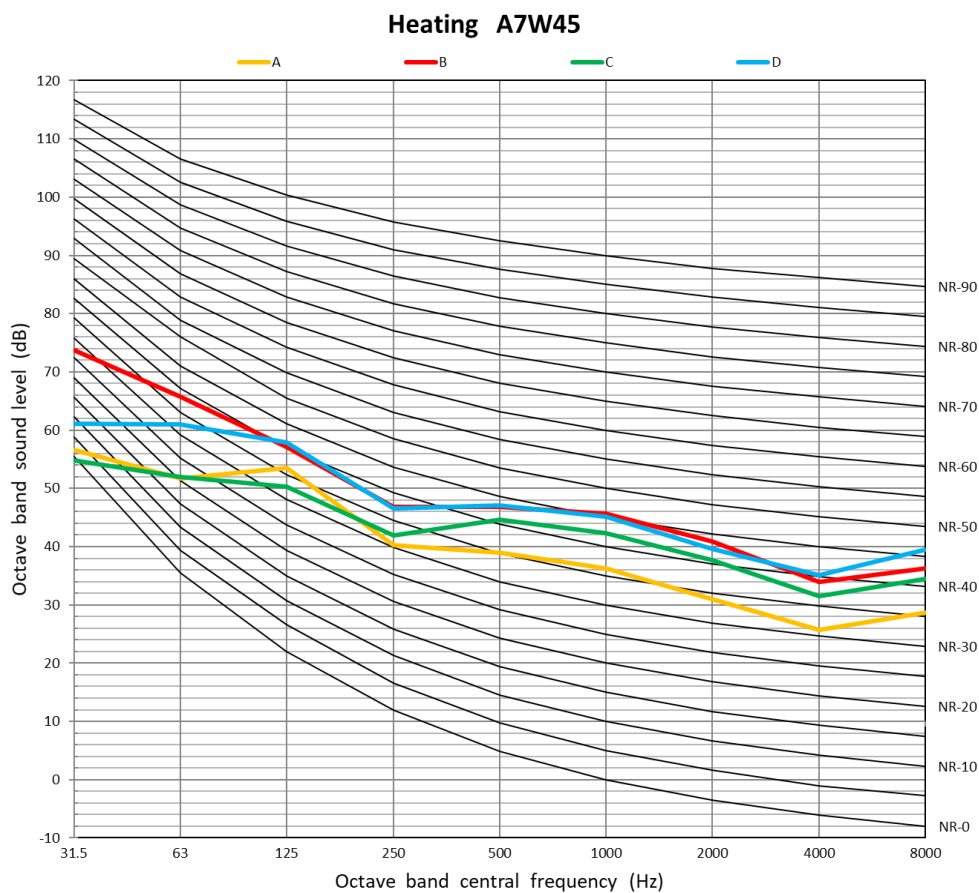

10kW

Cooling A35W18

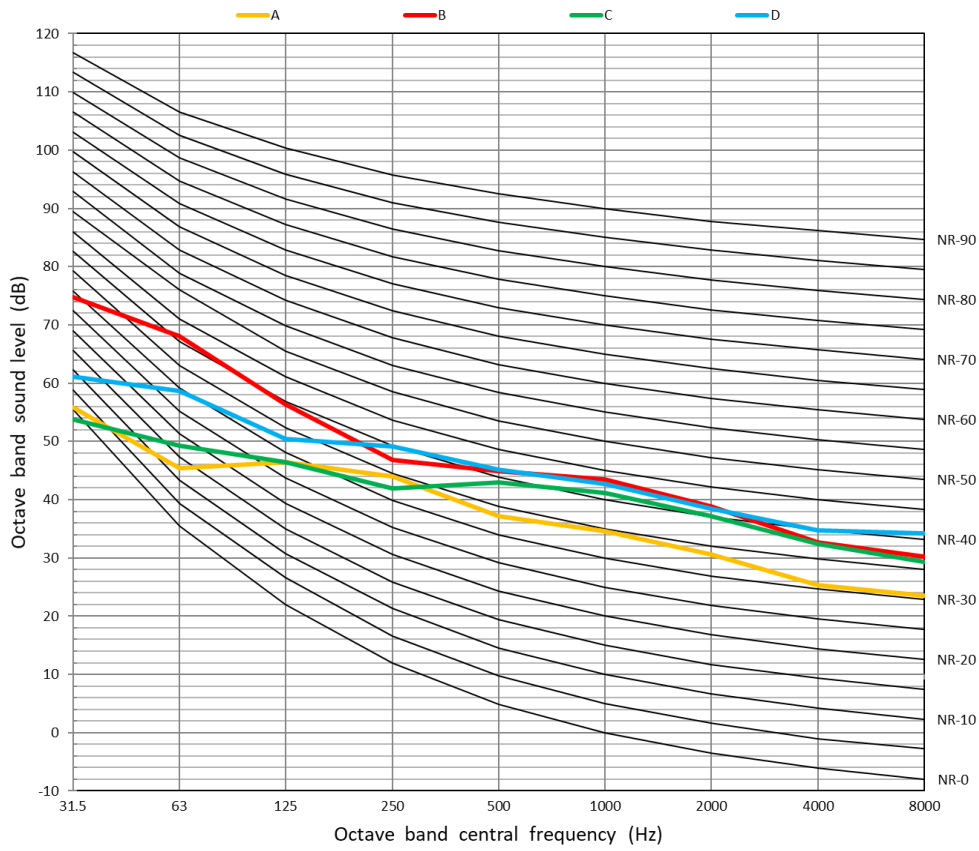

Cooling A35W7

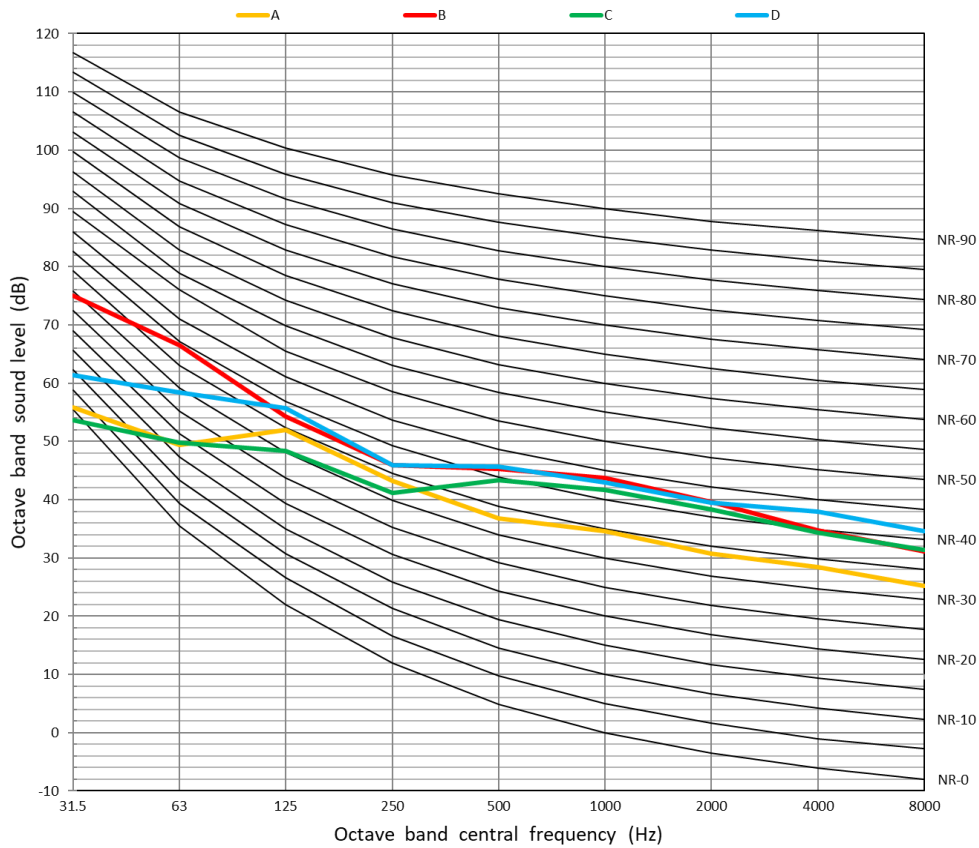

7.2.5 12kW 1Ph

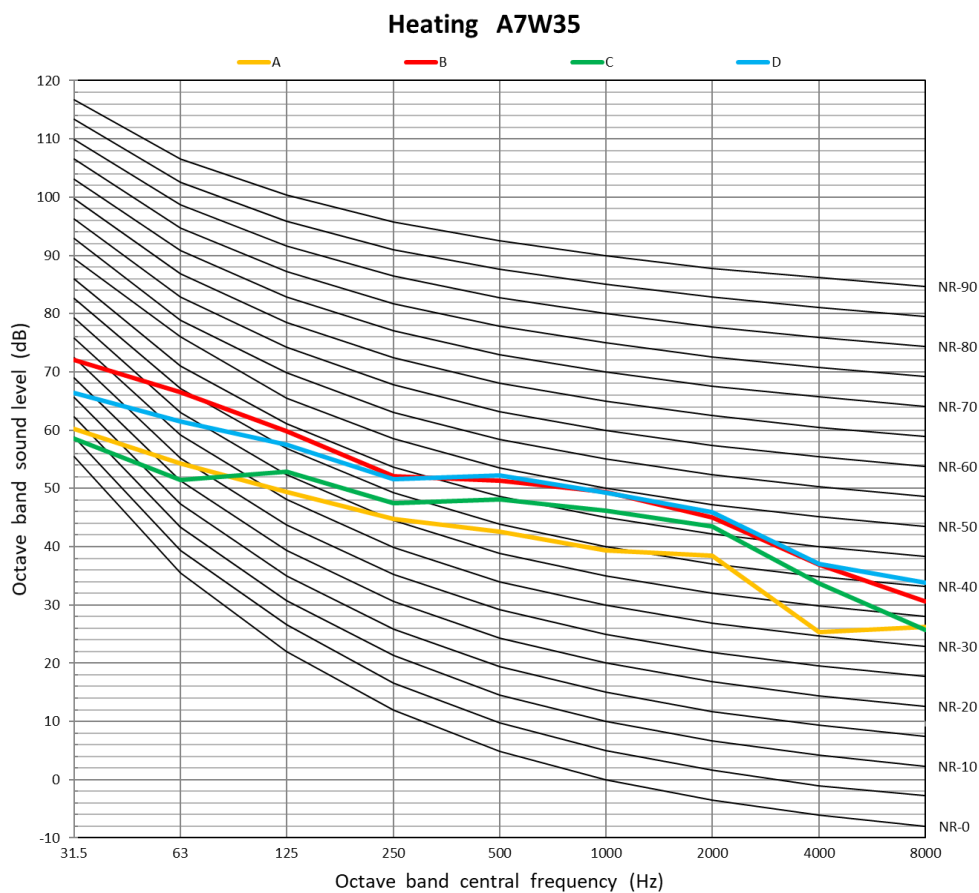
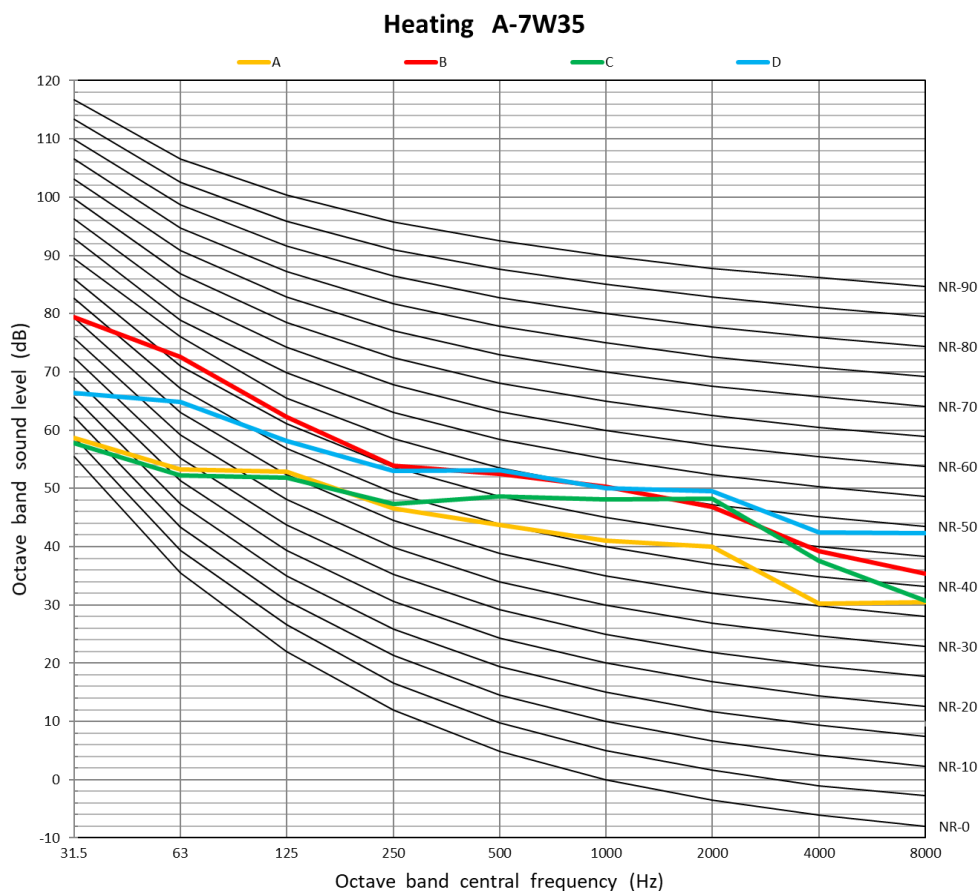

12kW 1Ph

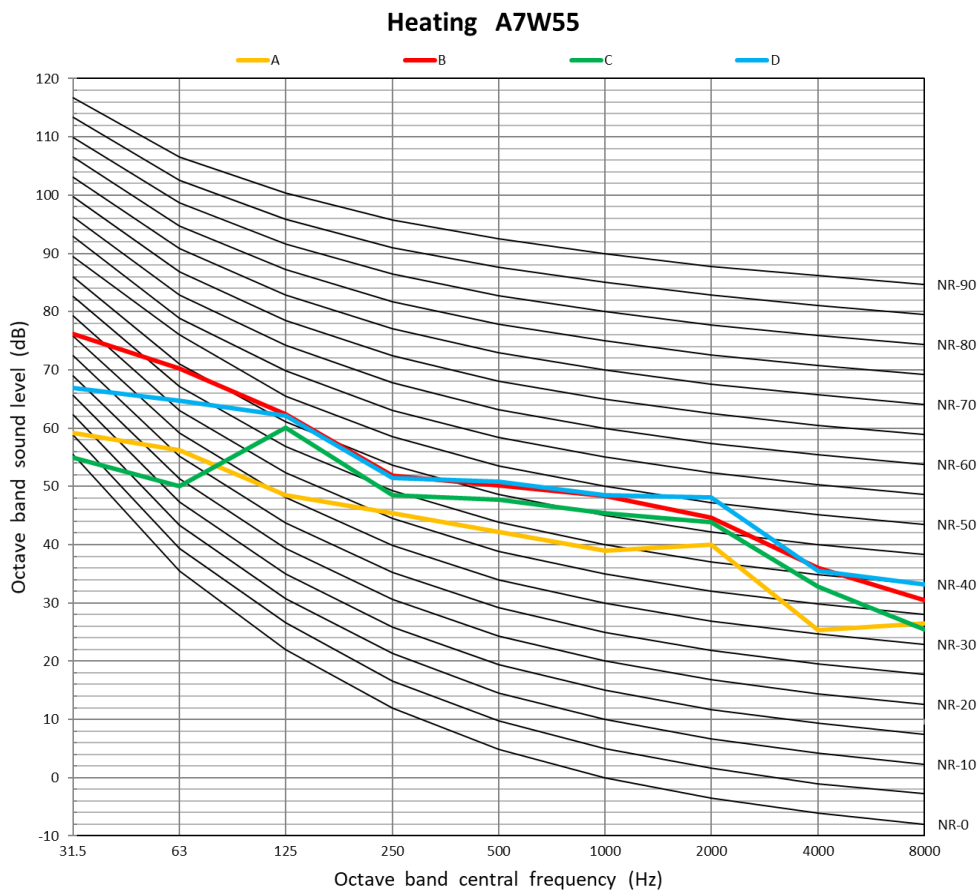
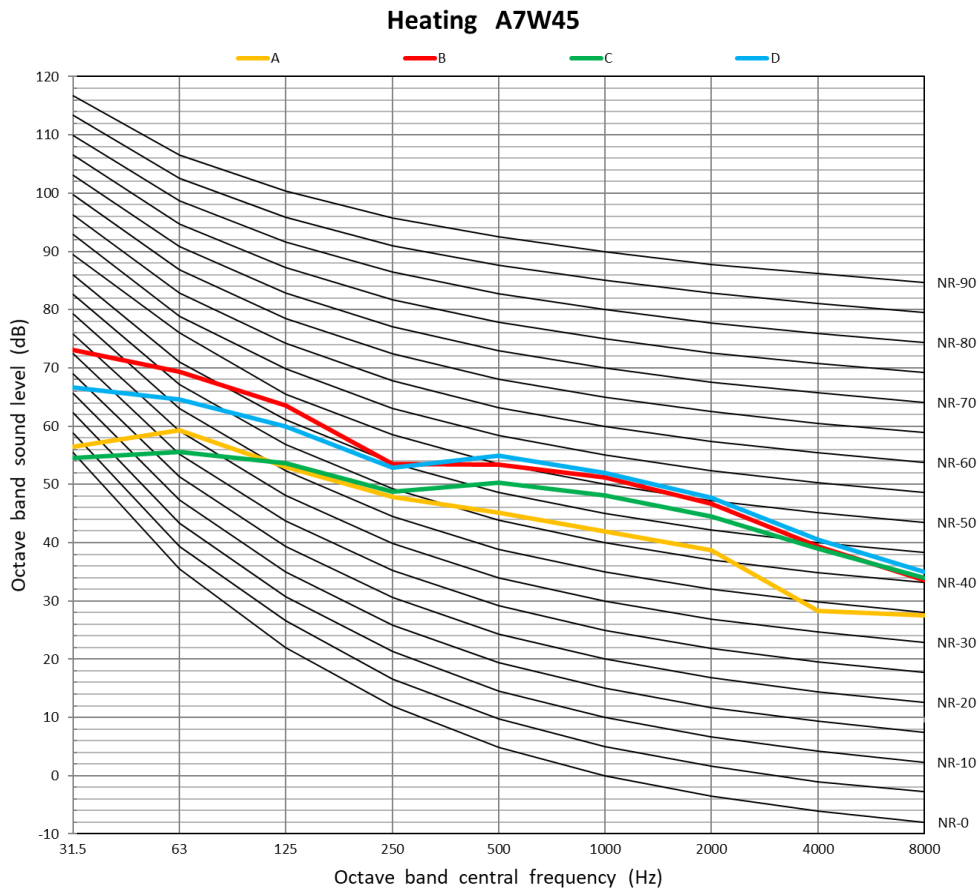

12kW 1Ph

Midea R290 M thermal Arctic HT Series Engineering Data Book

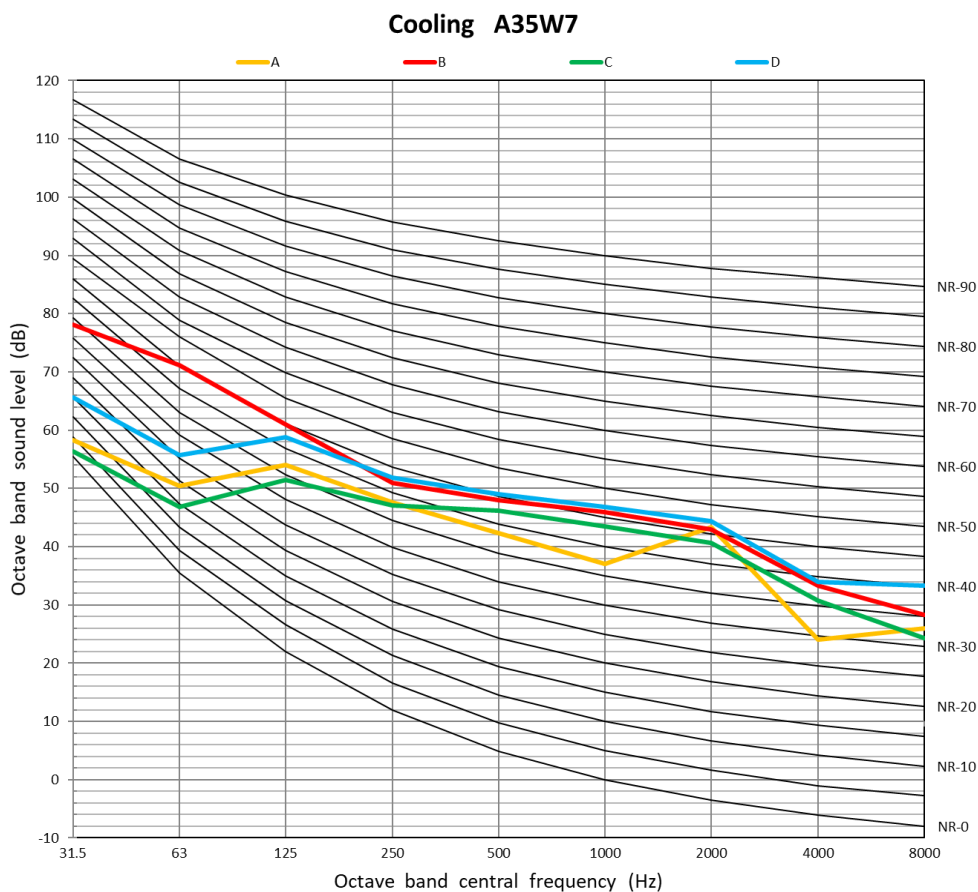
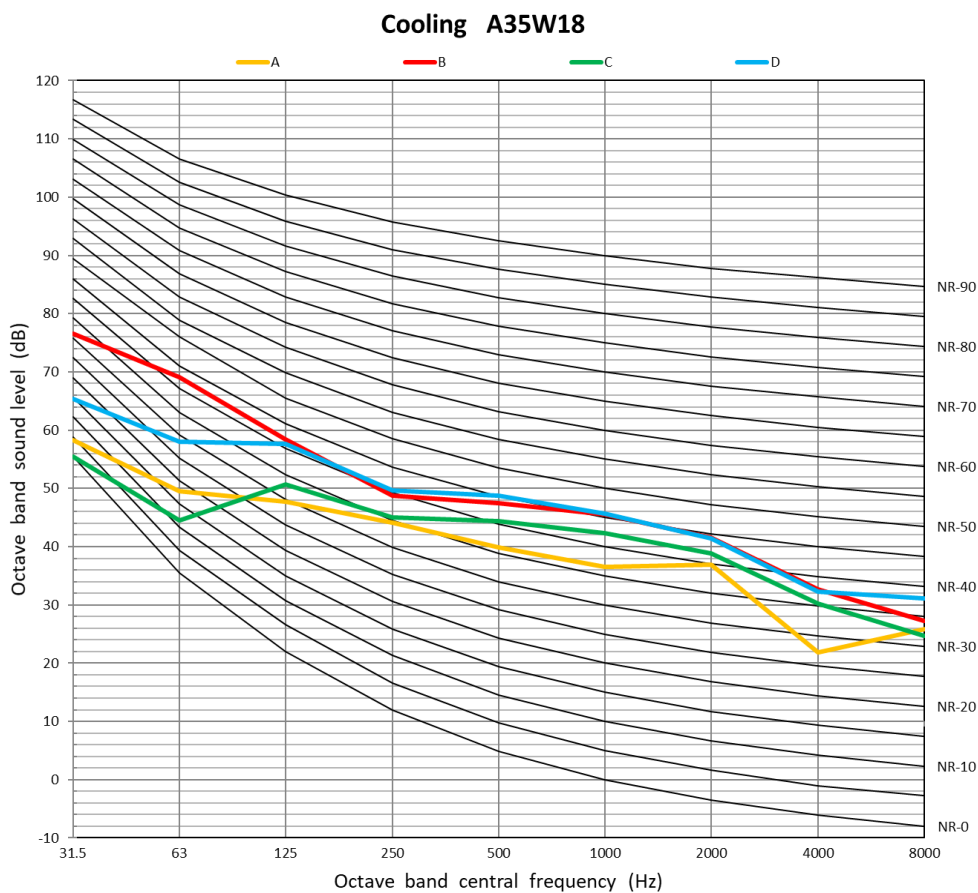

7.2.6 14kW 1Ph

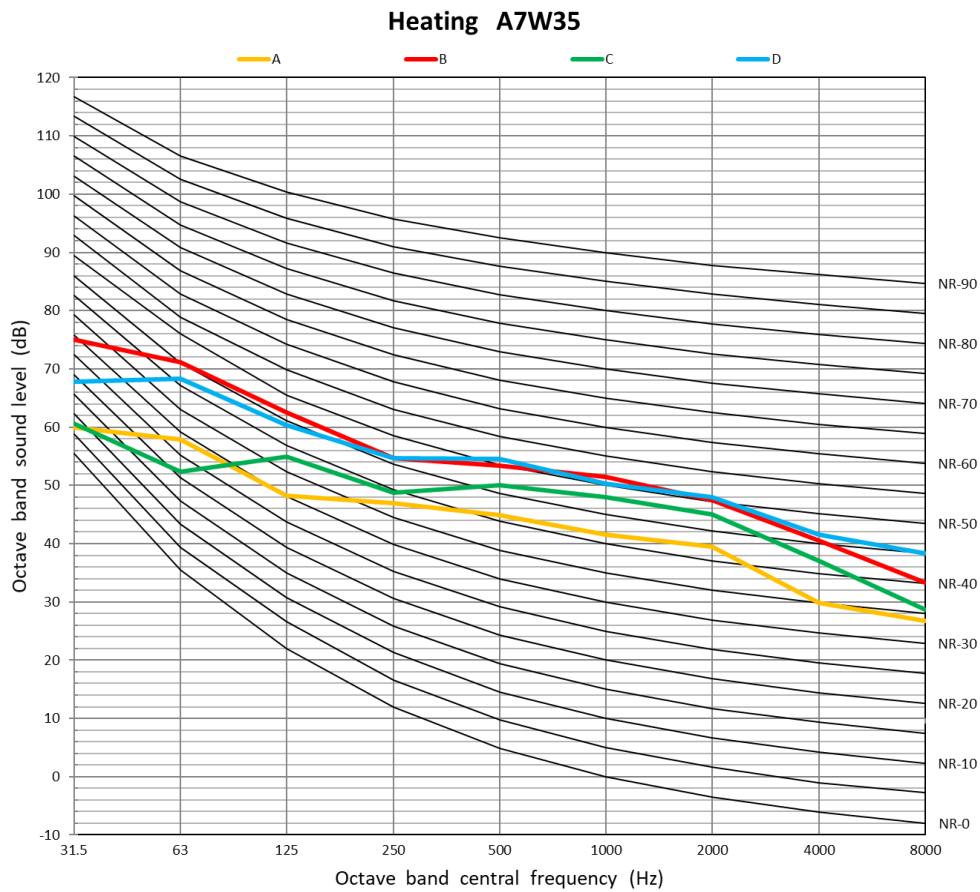
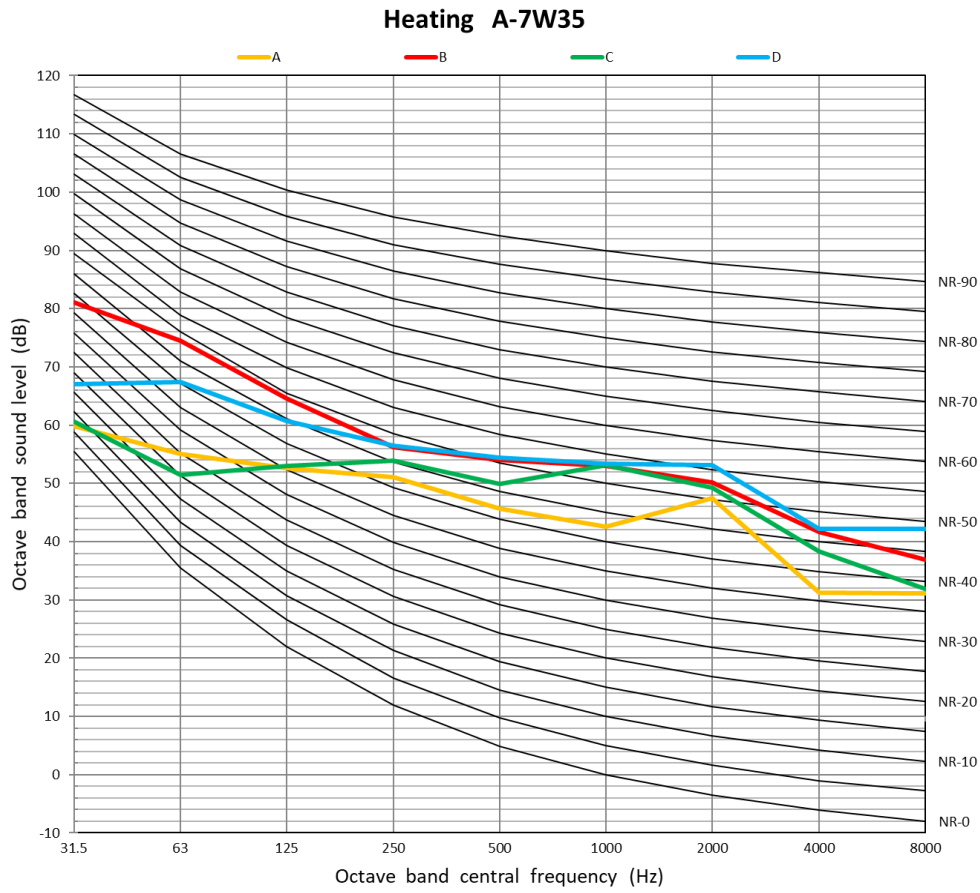

14kW 1Ph

Midea R290 M thermal Arctic HT Series Engineering Data Book

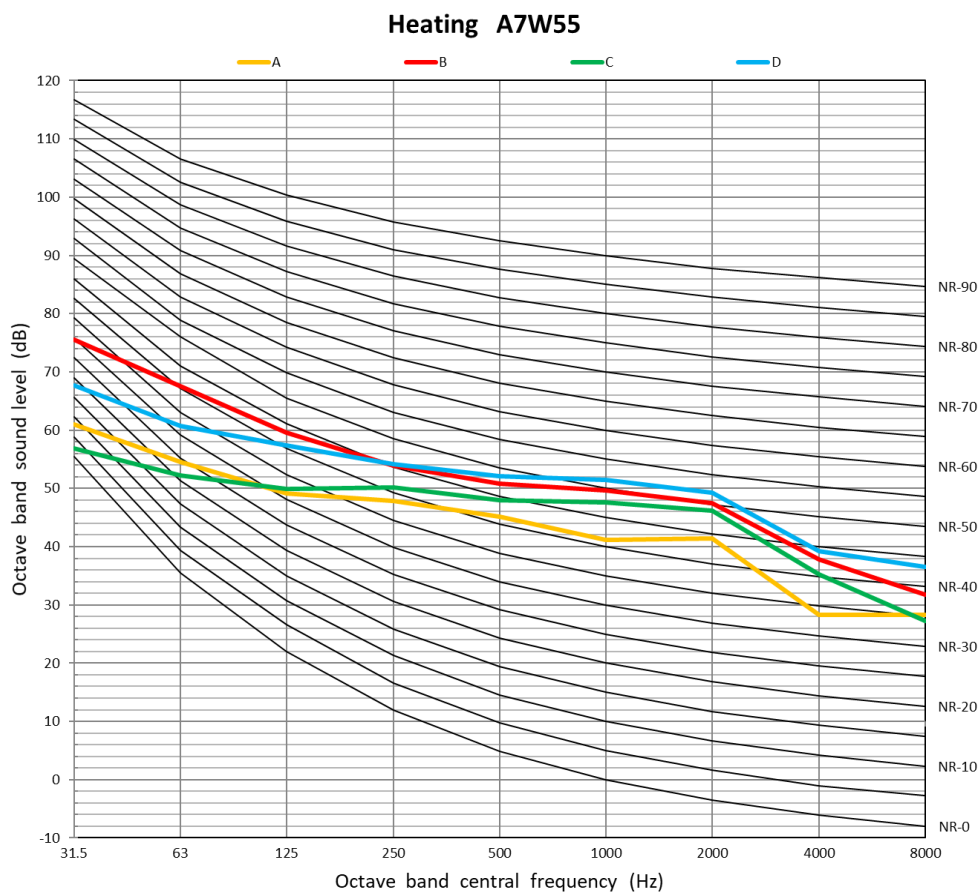
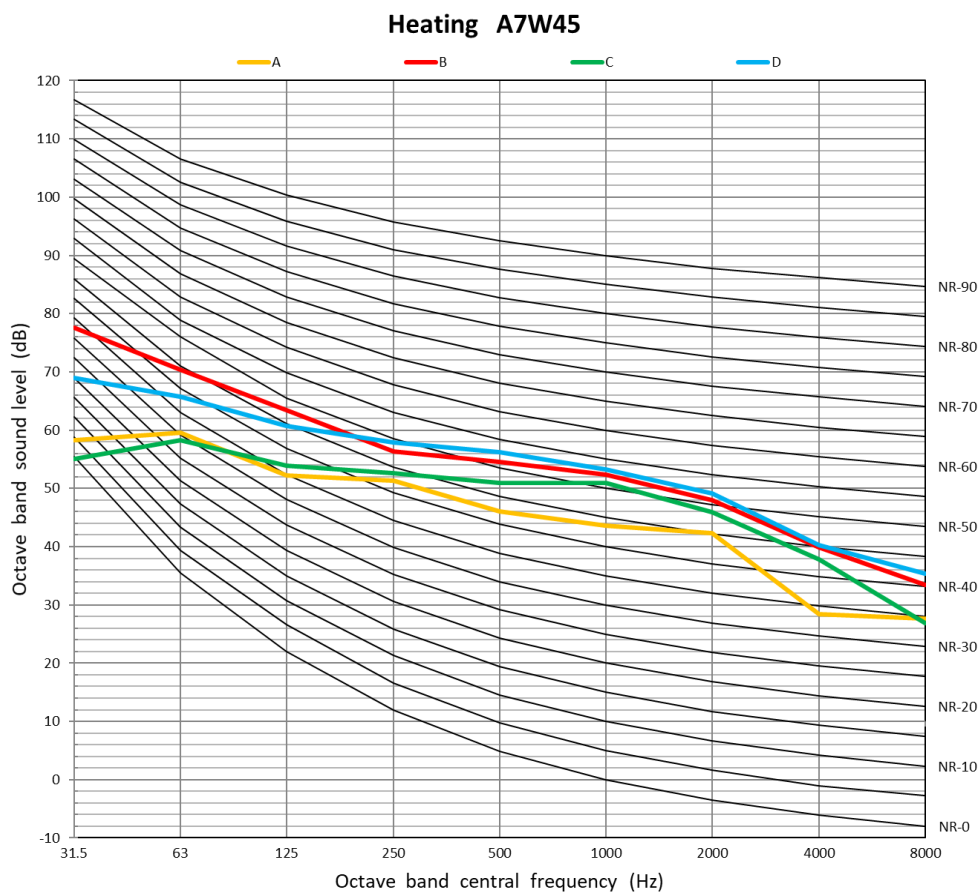

14kW 1Ph

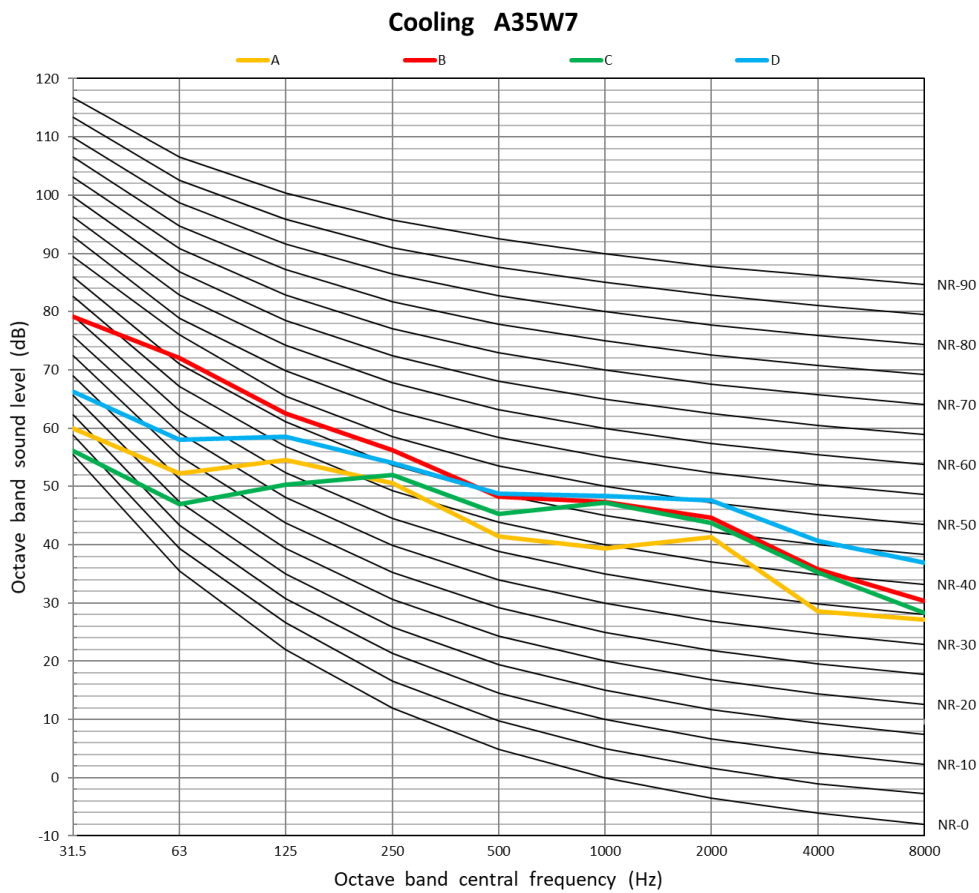
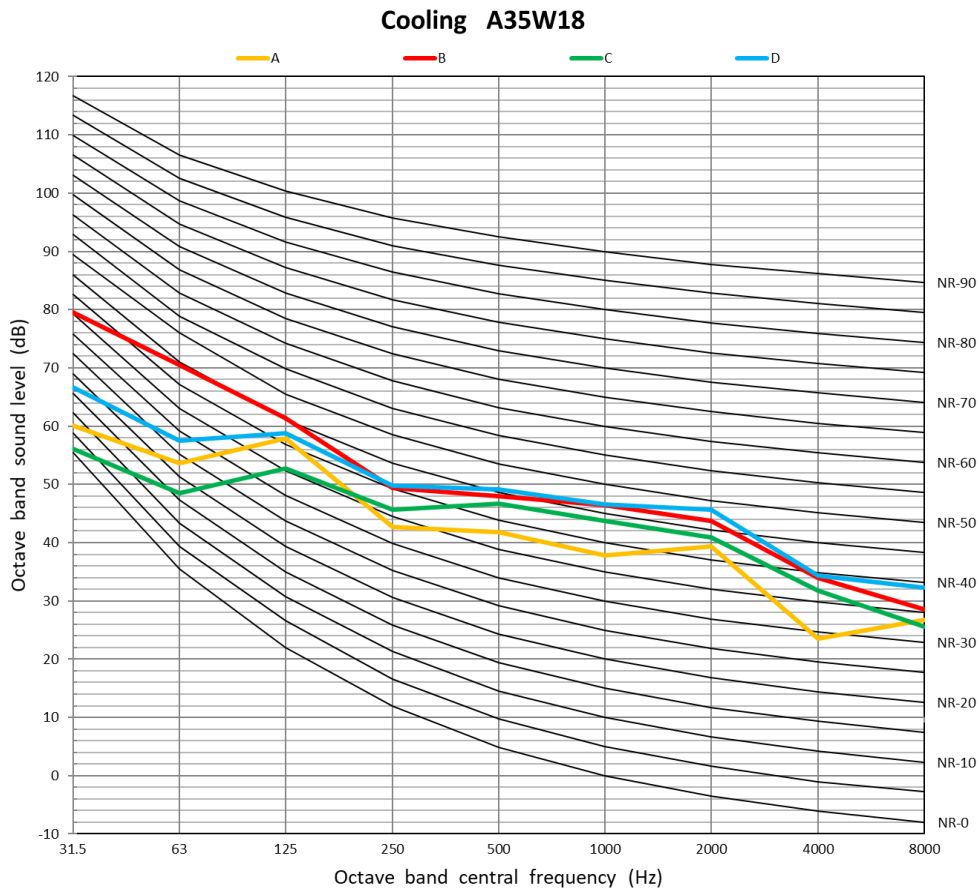

7.2.7 16kW 1Ph

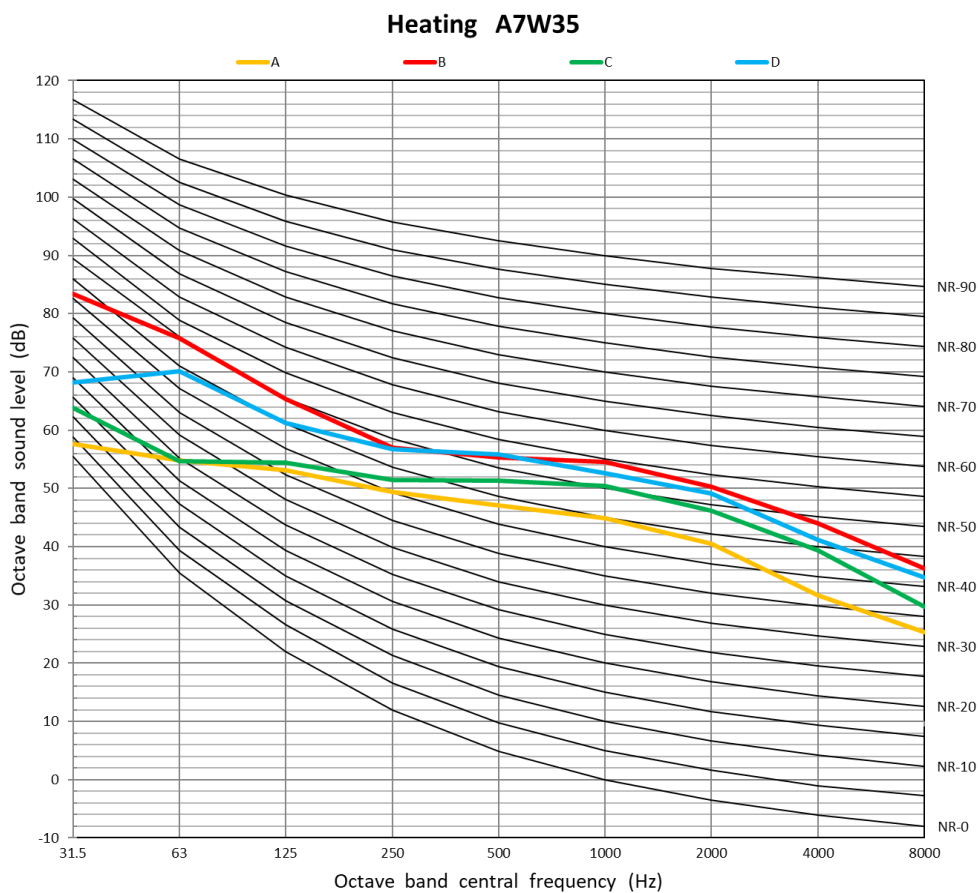
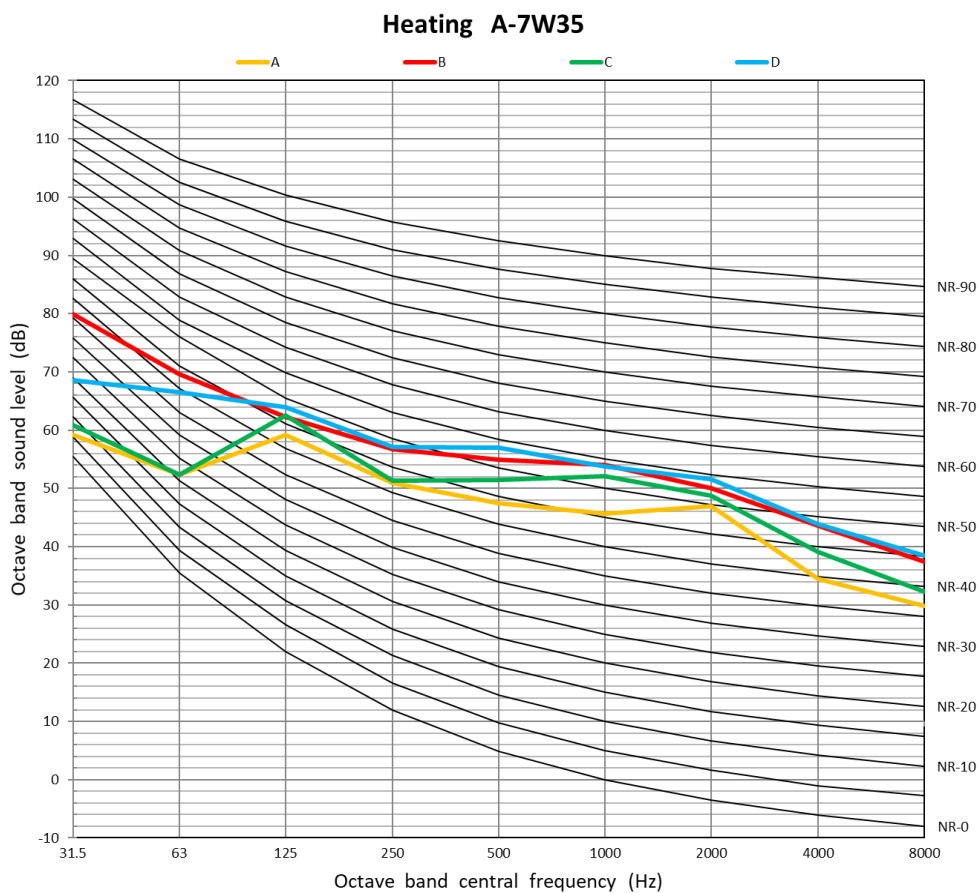

16kW 1Ph

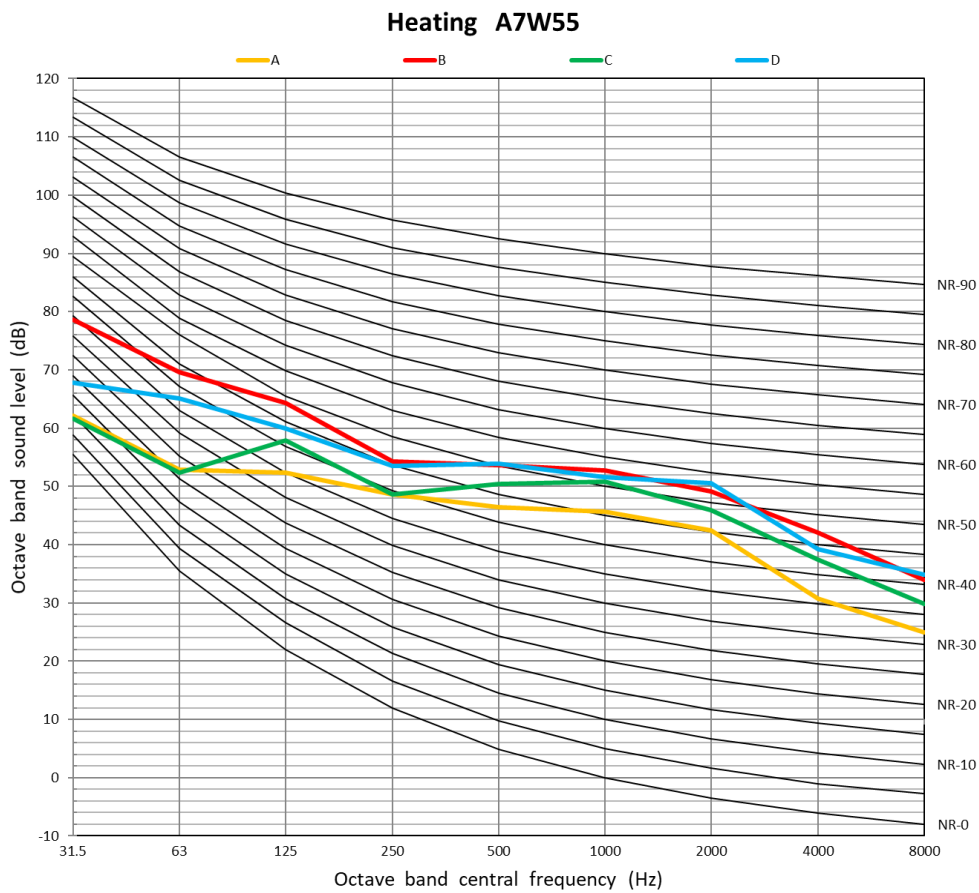
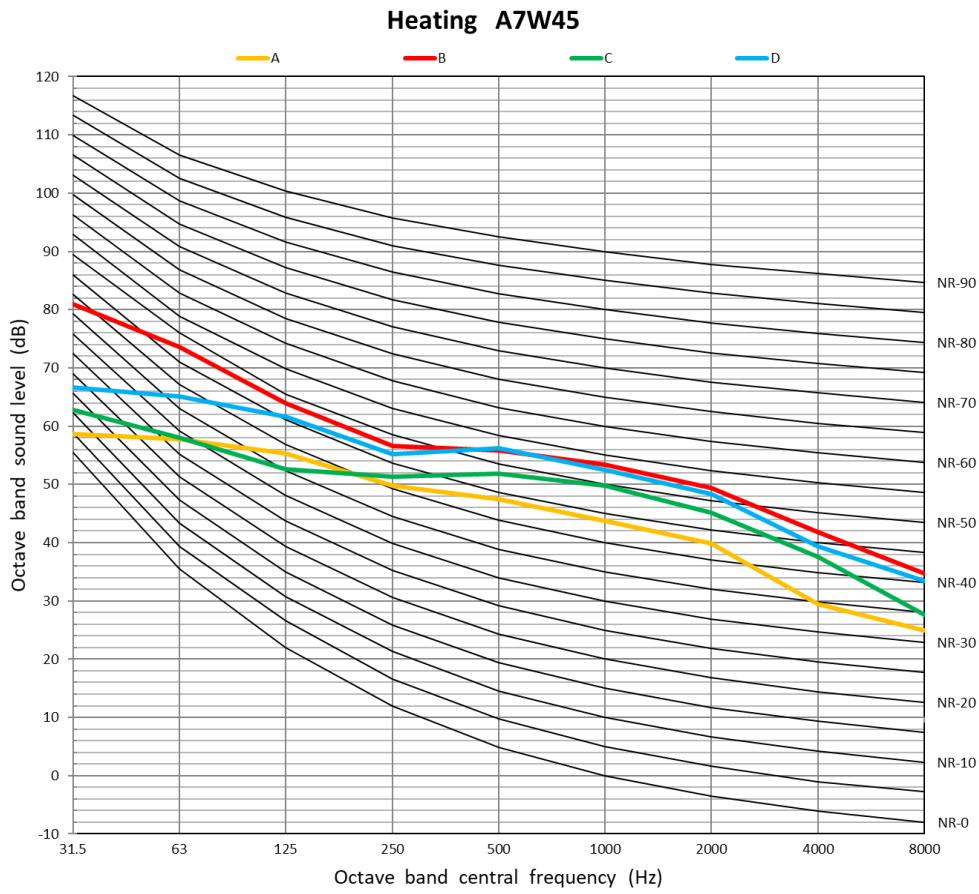

16kW 1Ph

Midea R290 M thermal Arctic HT Series Engineering Data Book

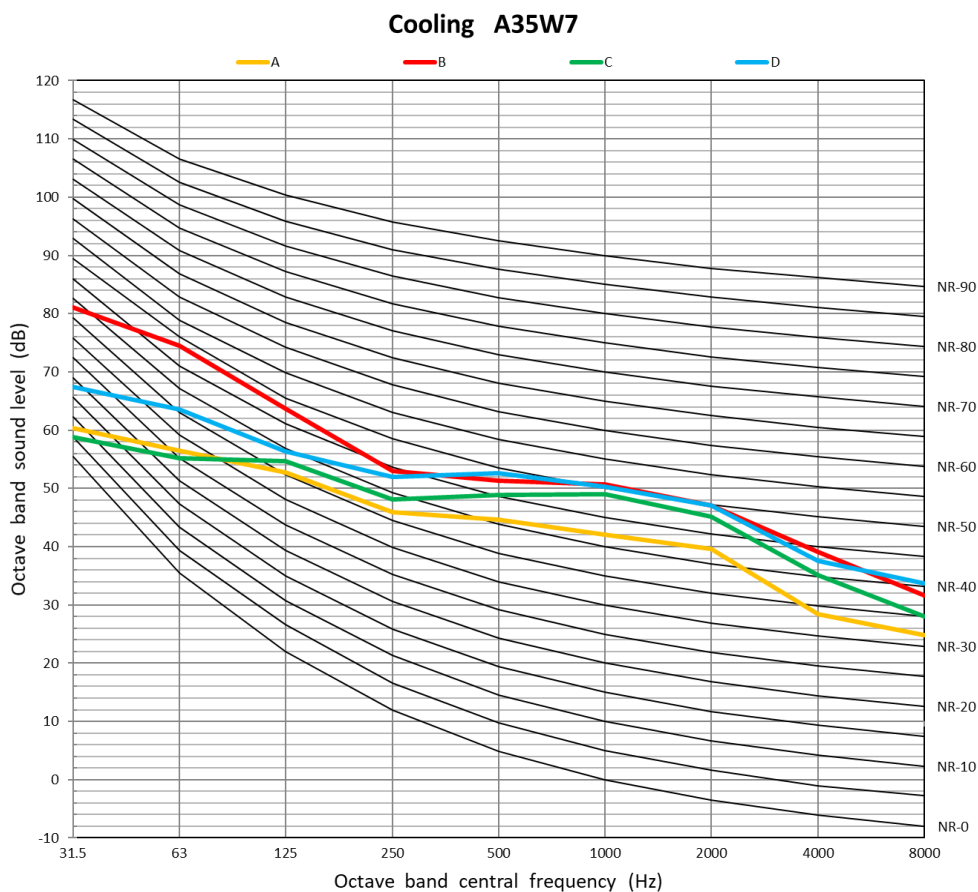
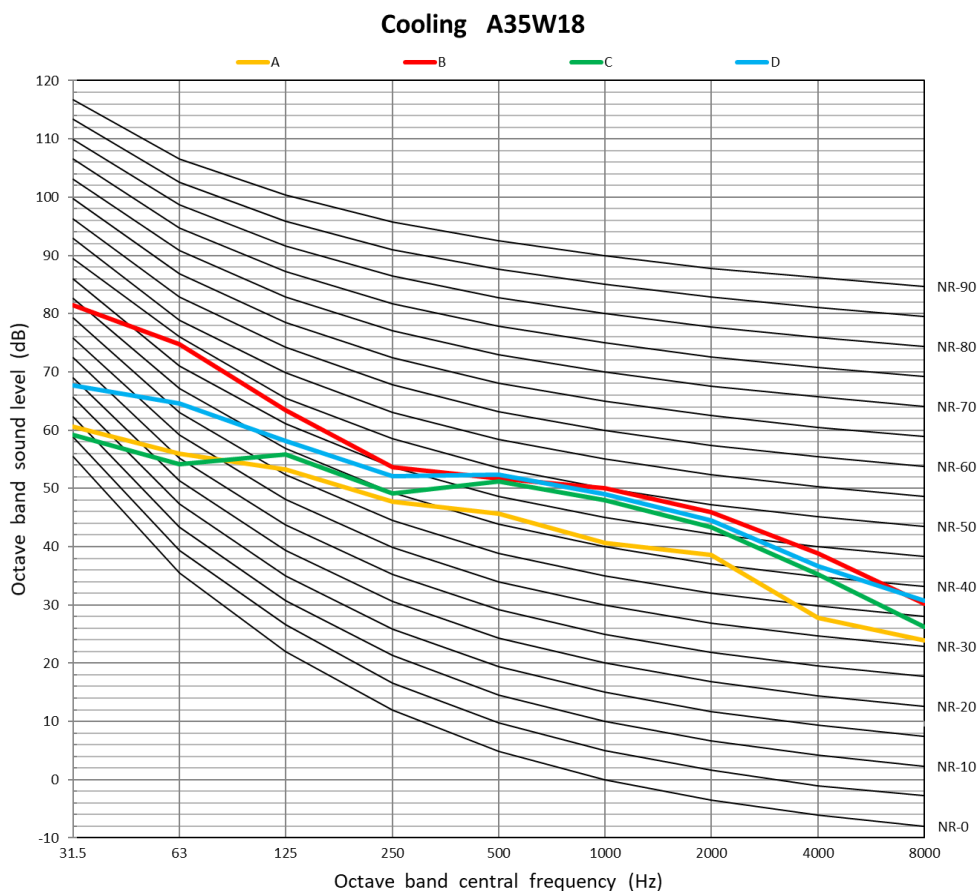

7.2.8 12kW 3Ph

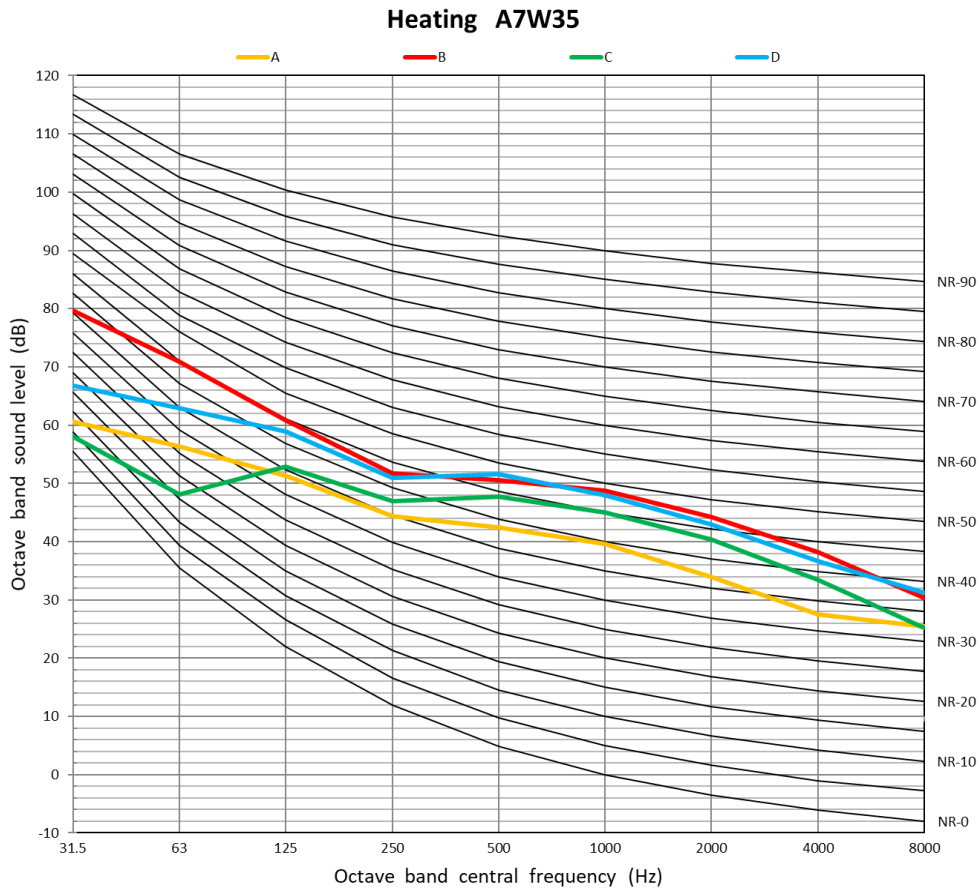
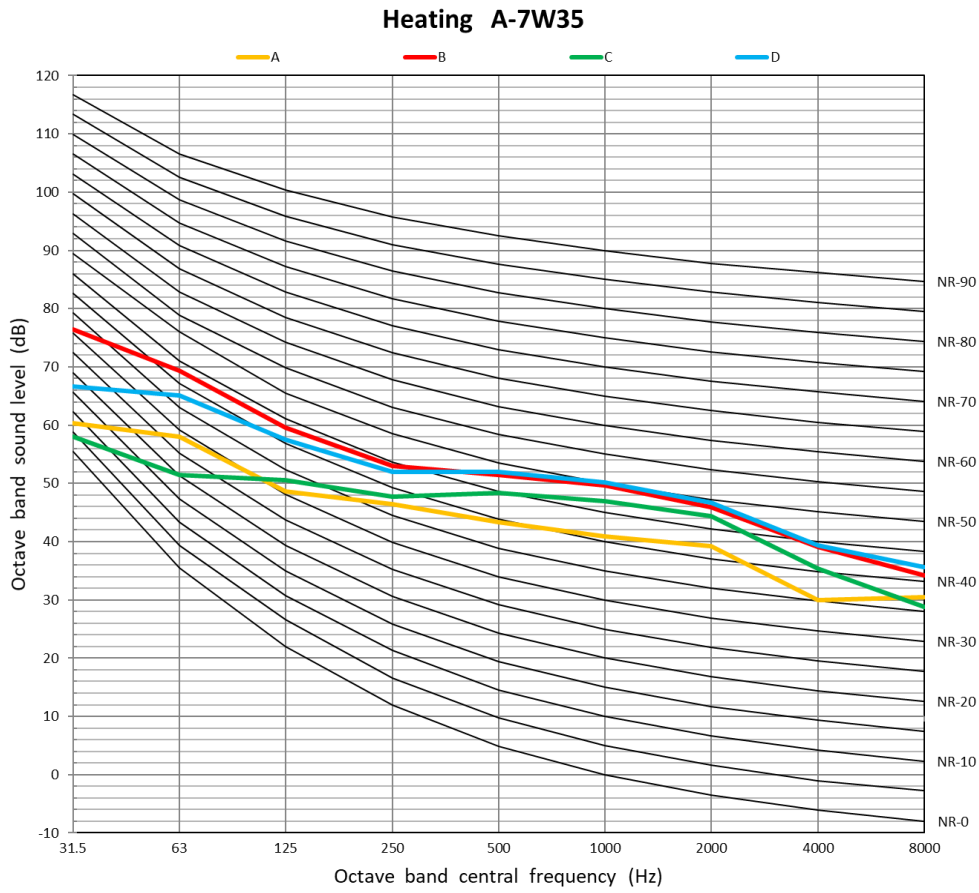

12kW 3Ph

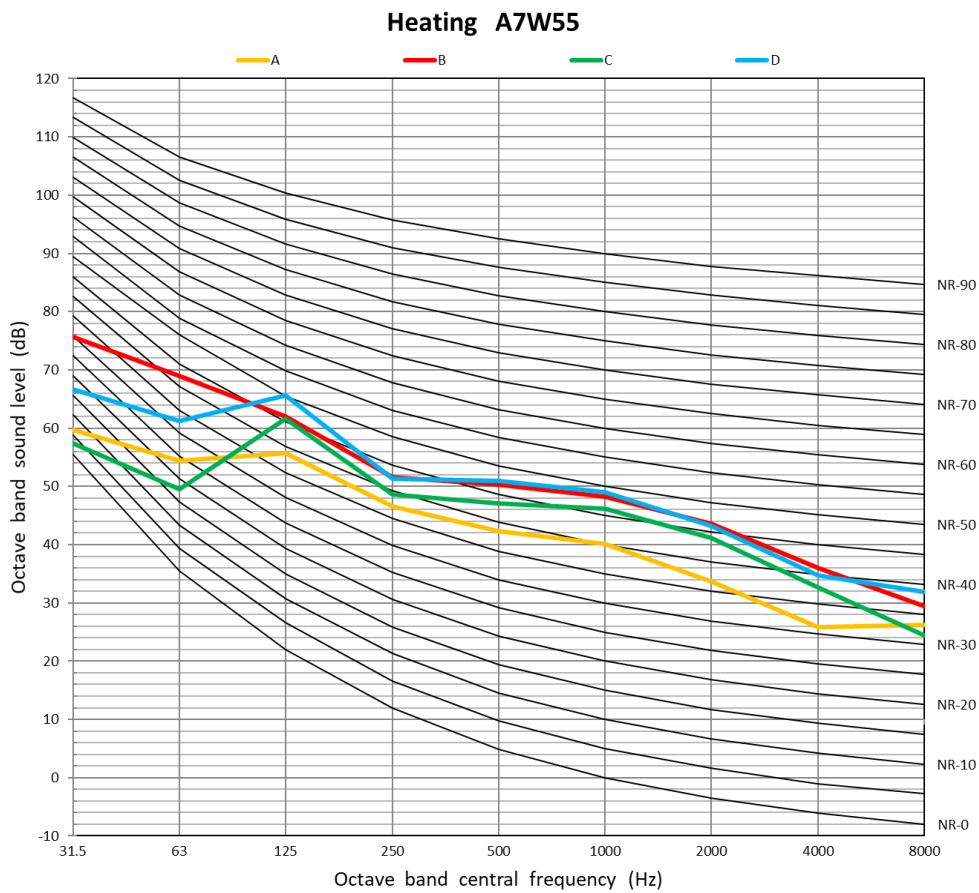
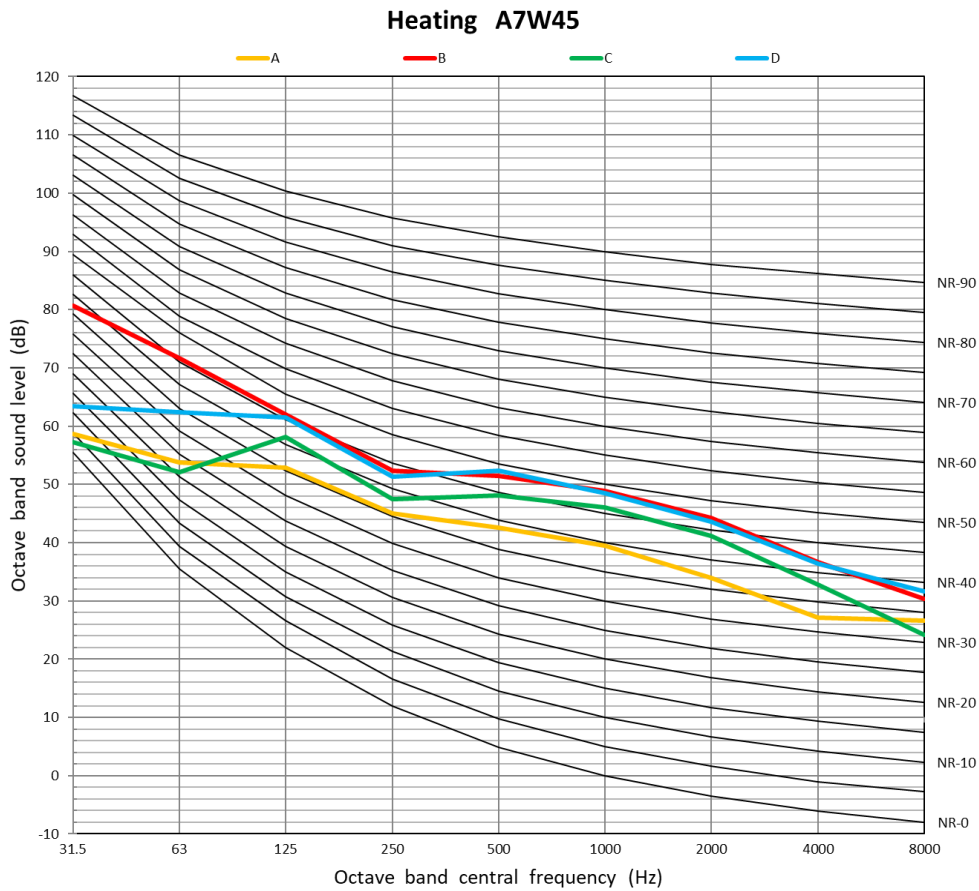

12kW 3Ph

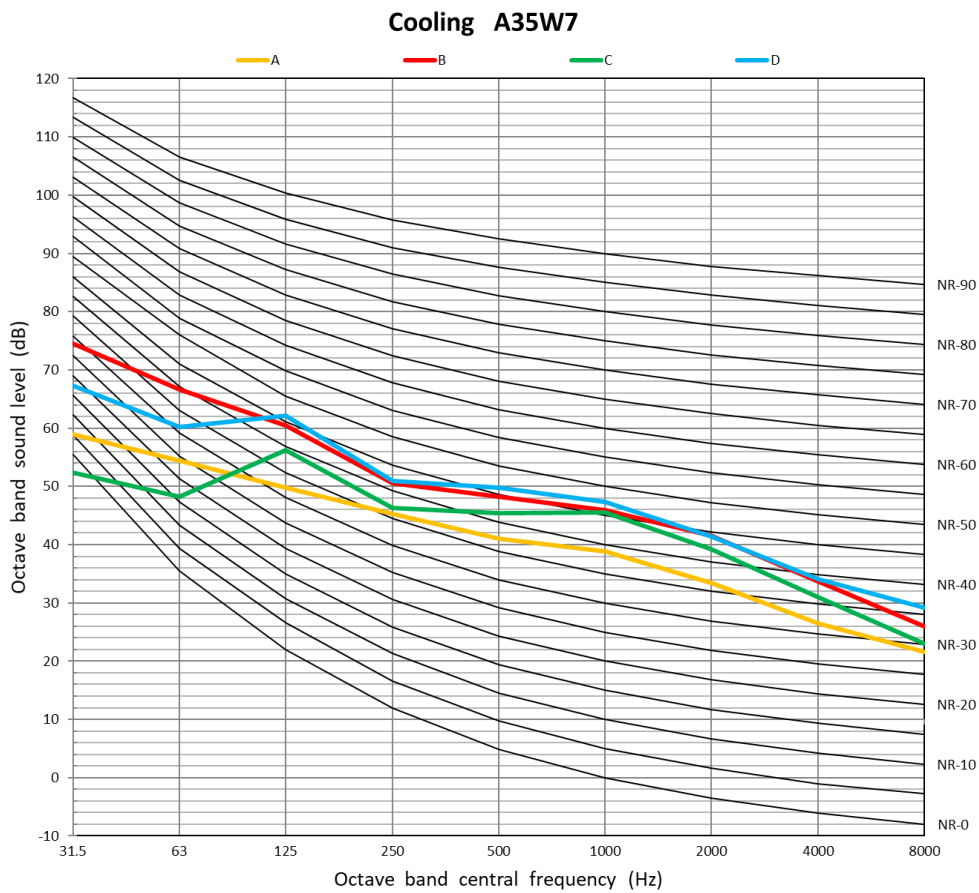
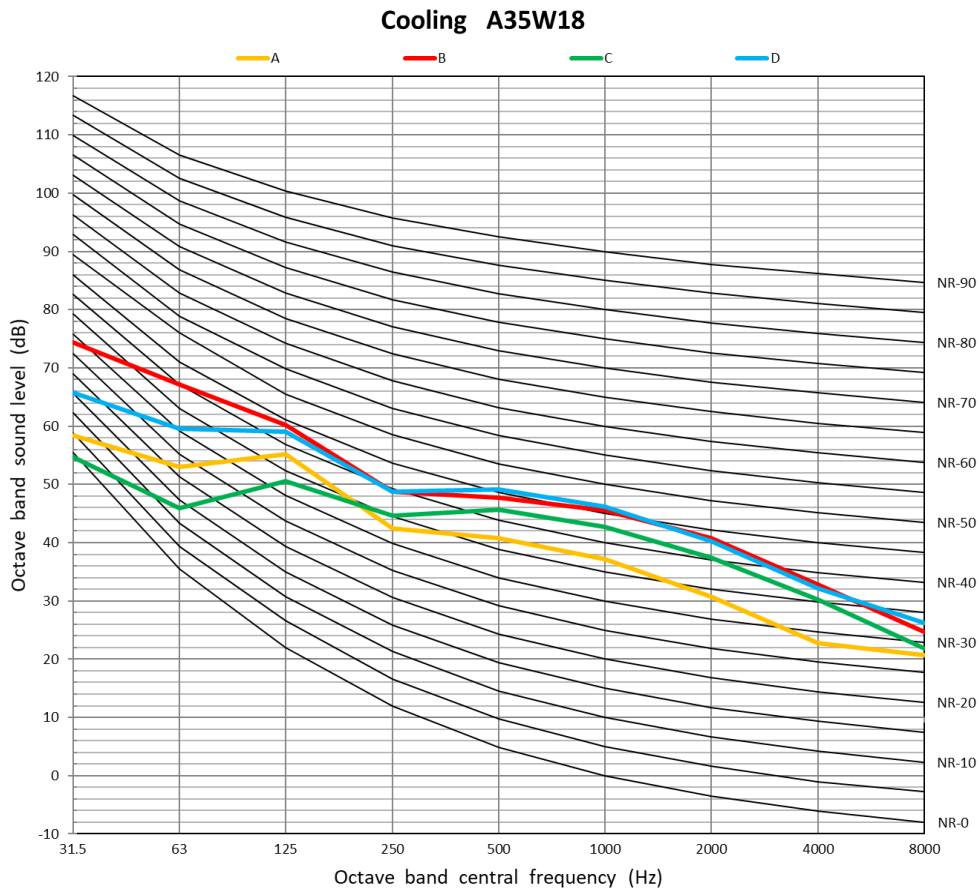

7.2.9 14kW 3Ph

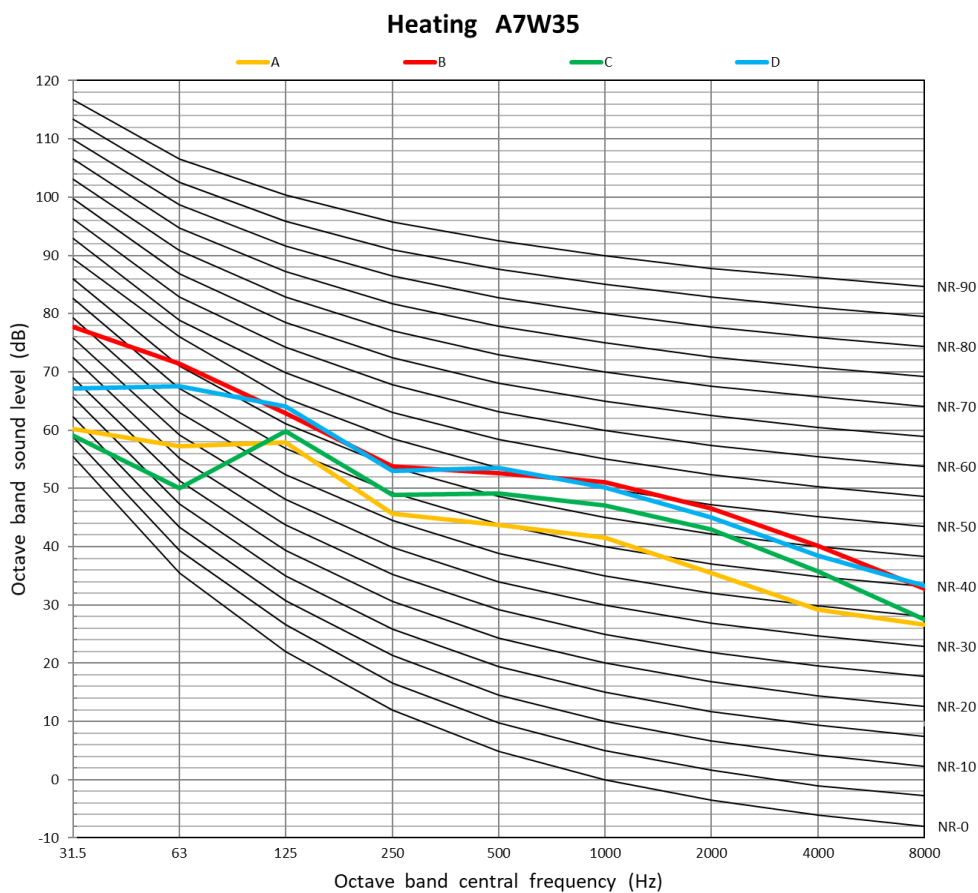
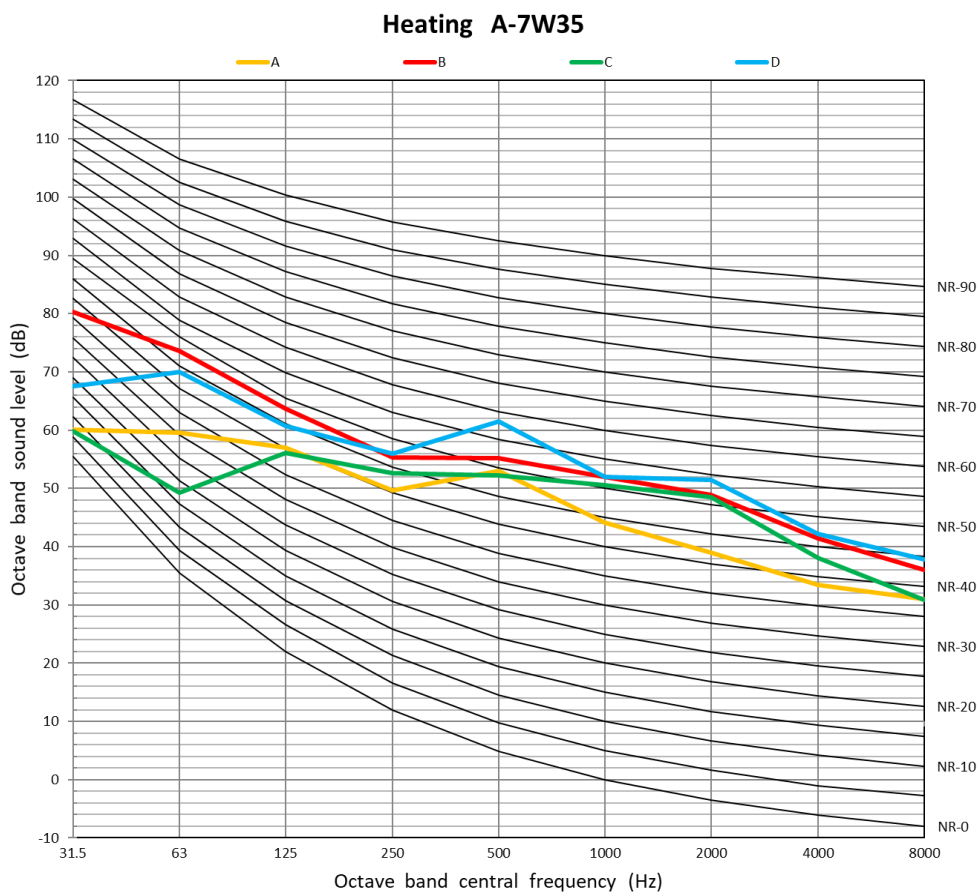

14kW 3Ph

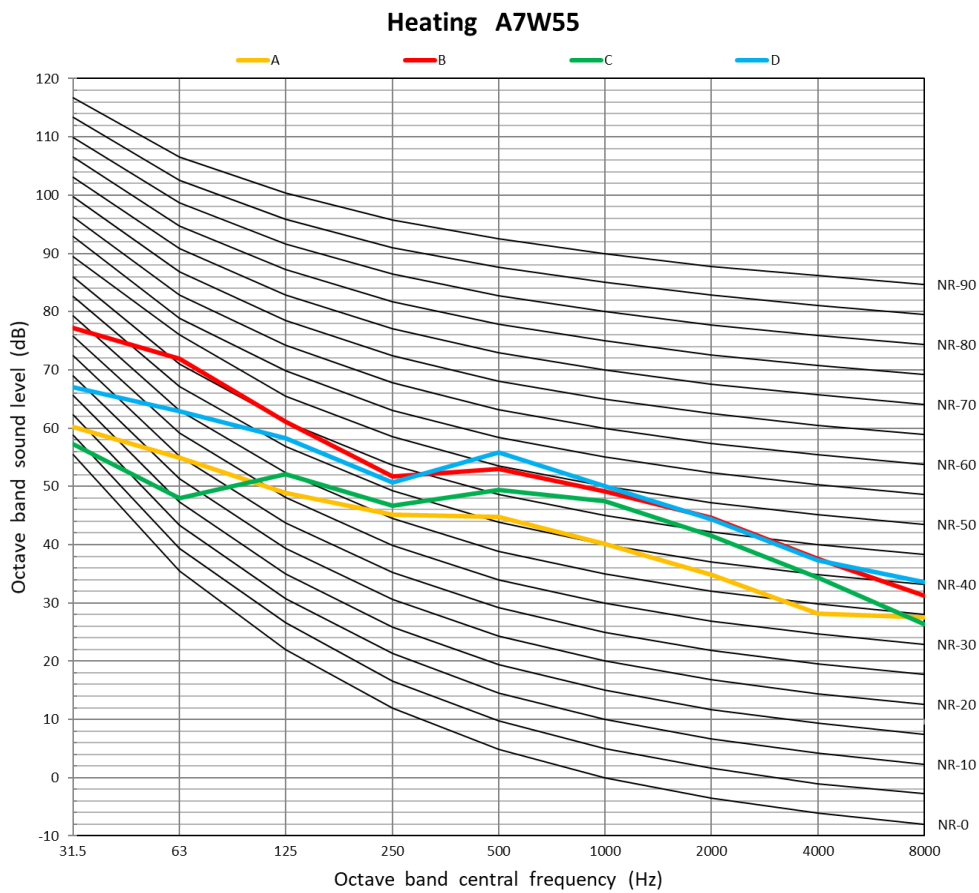
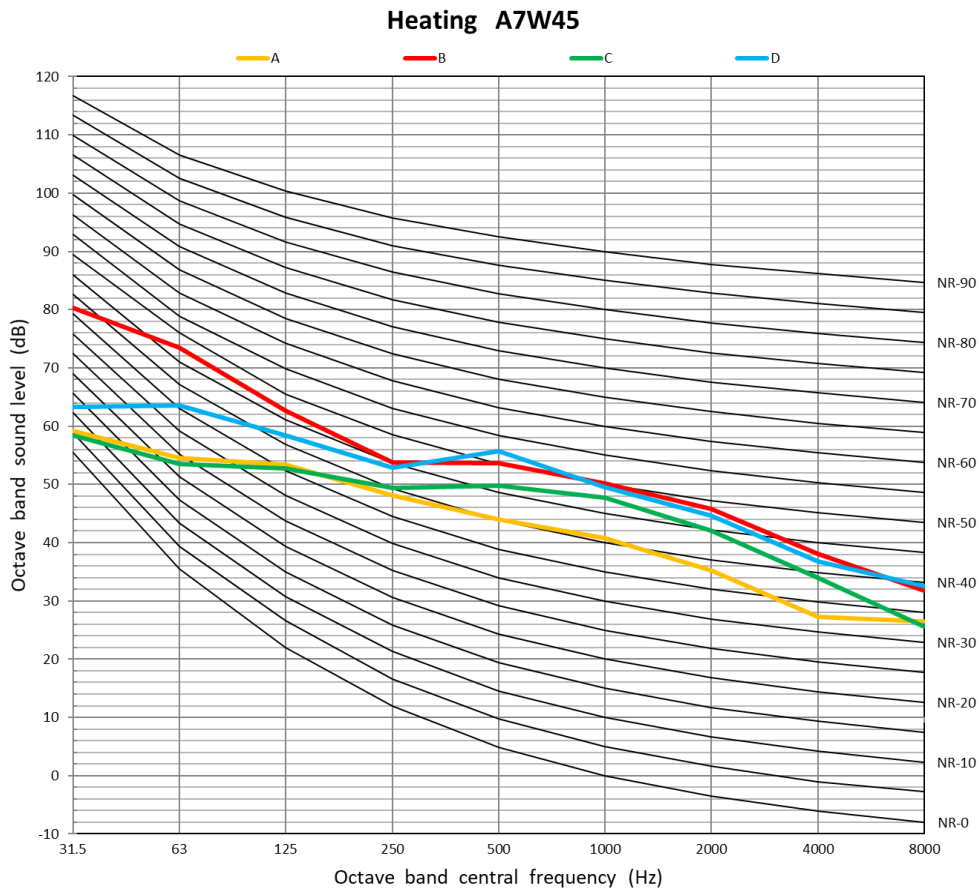

14kW 3Ph

Midea R290 M thermal Arctic HT Series Engineering Data Book

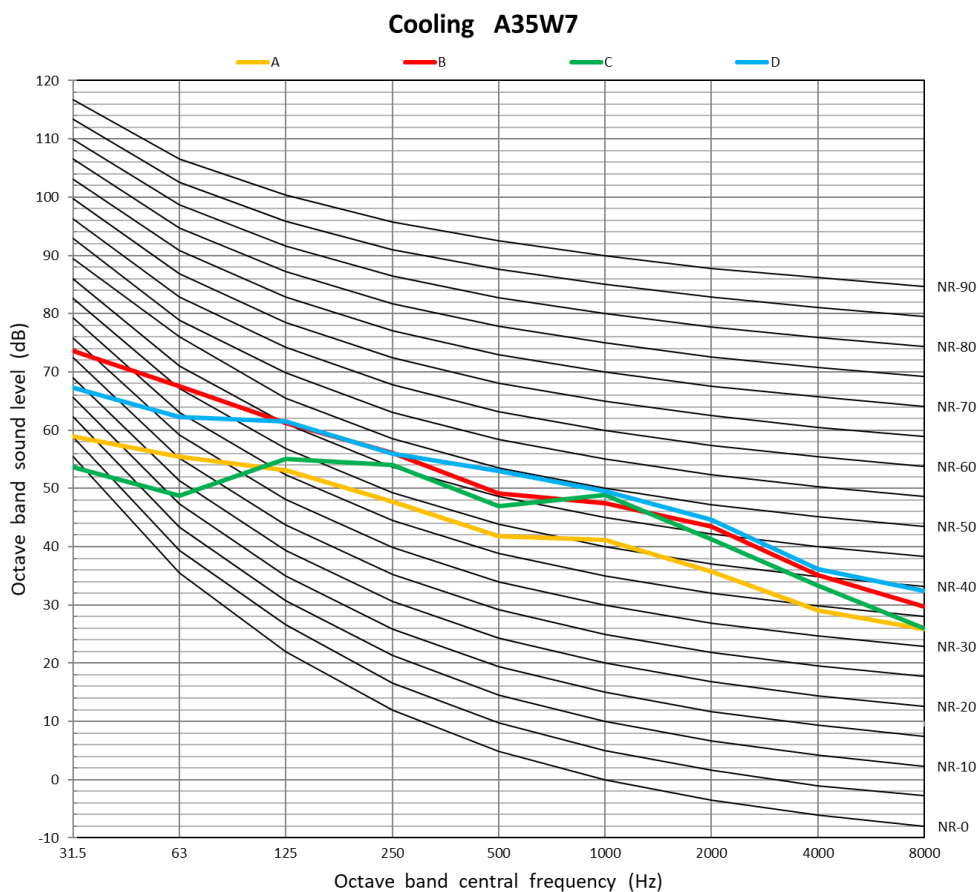
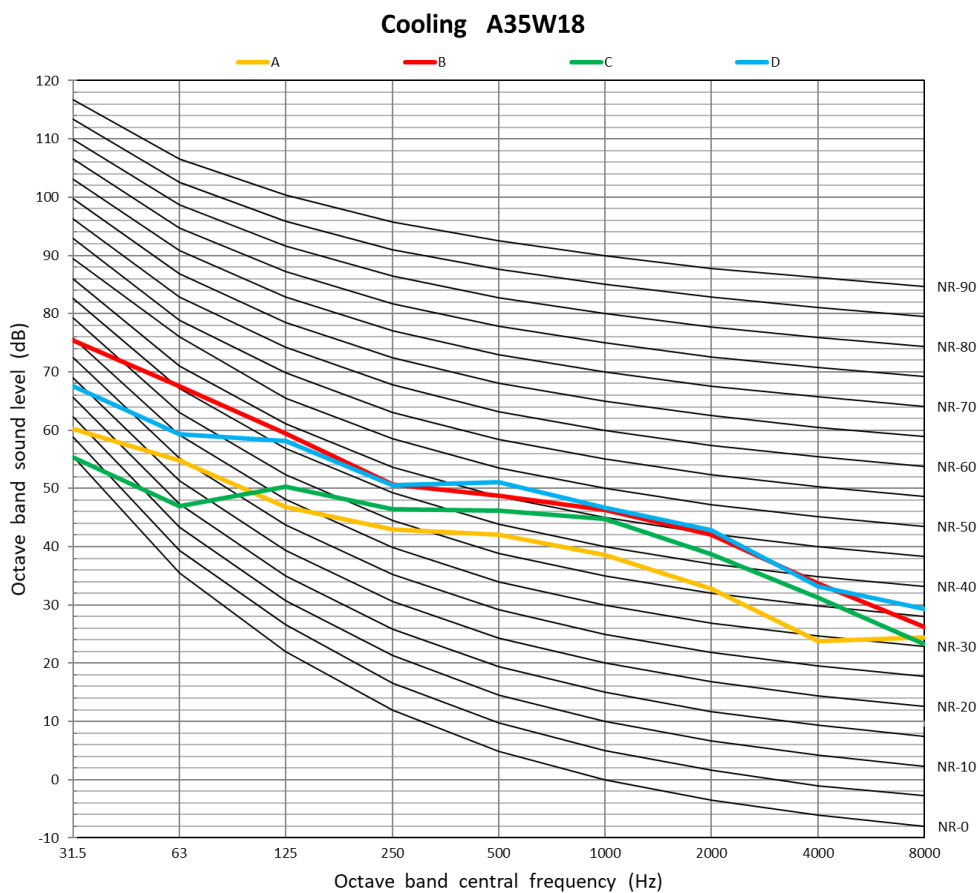

7.2.10 16kW 3Ph

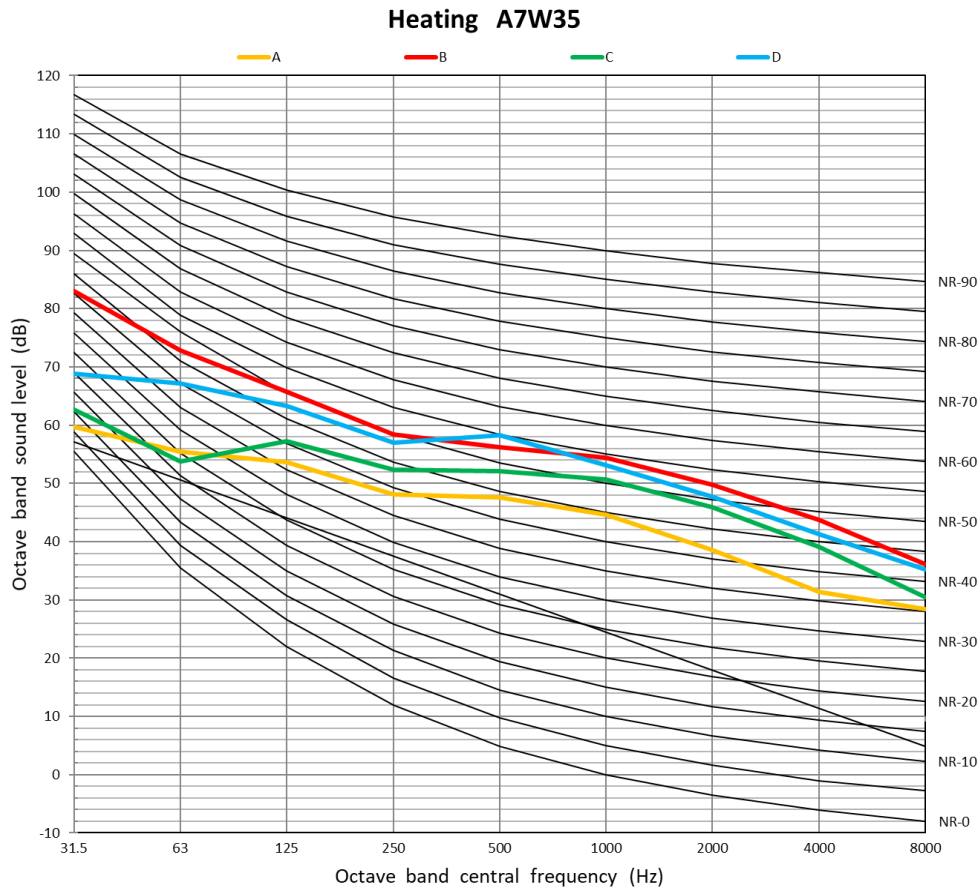
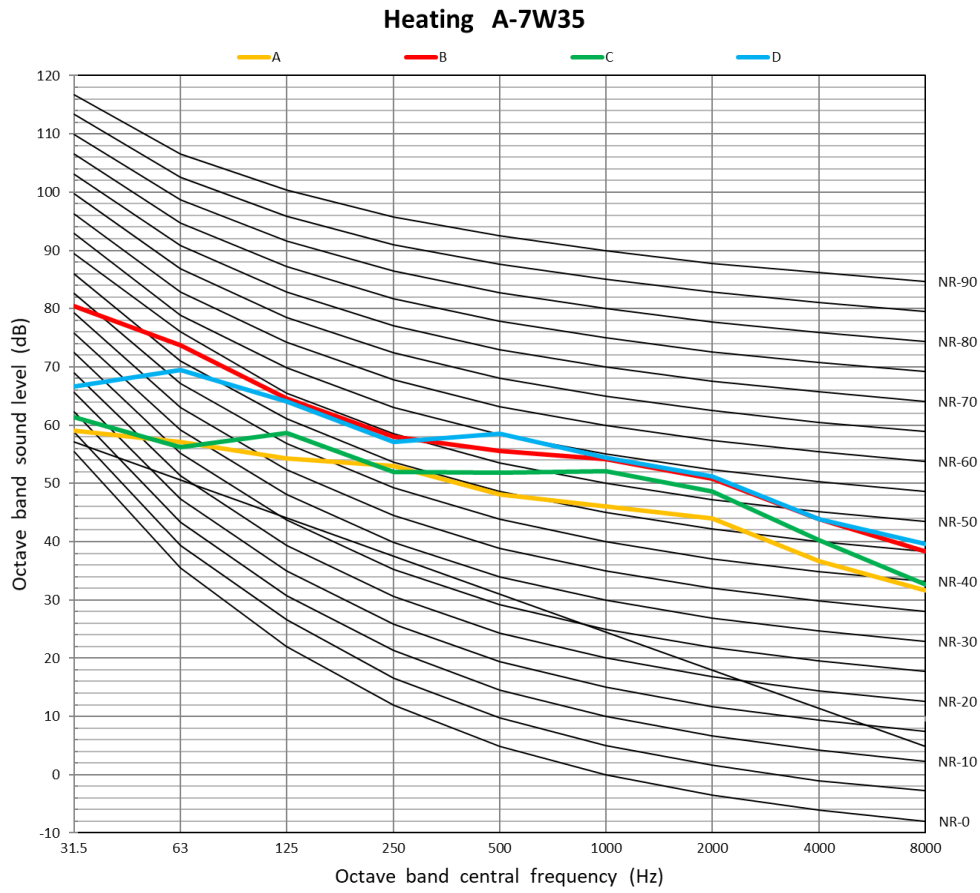

16kW 3Ph

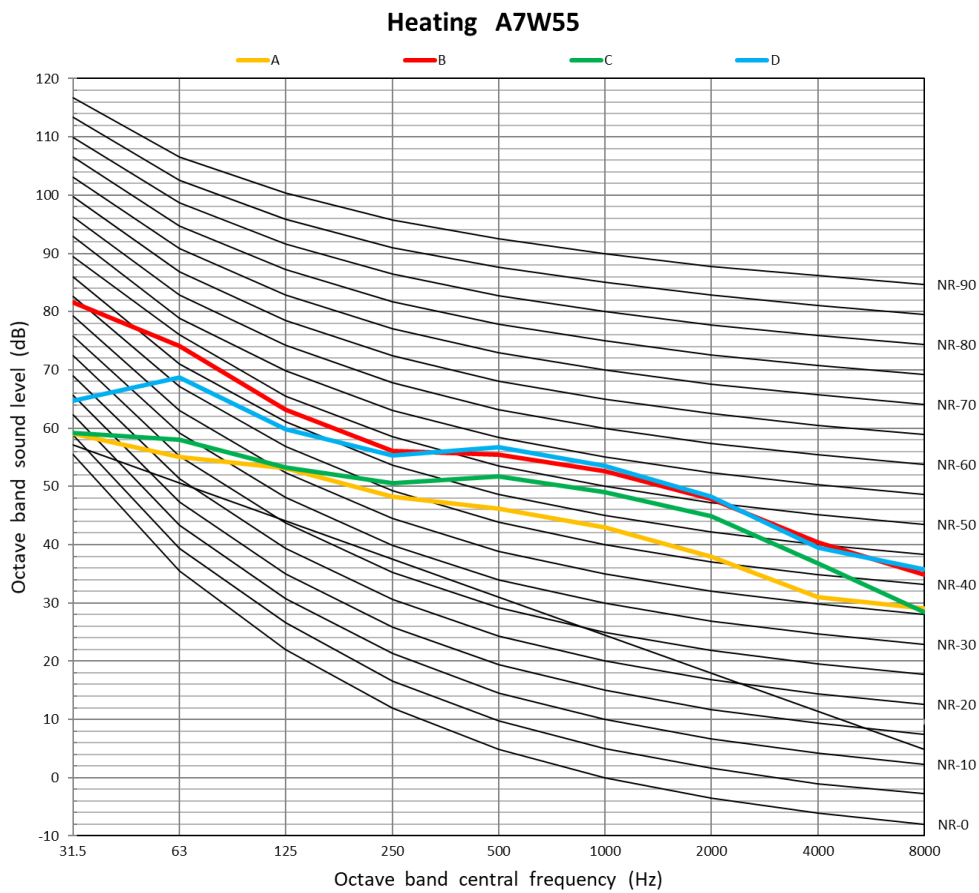
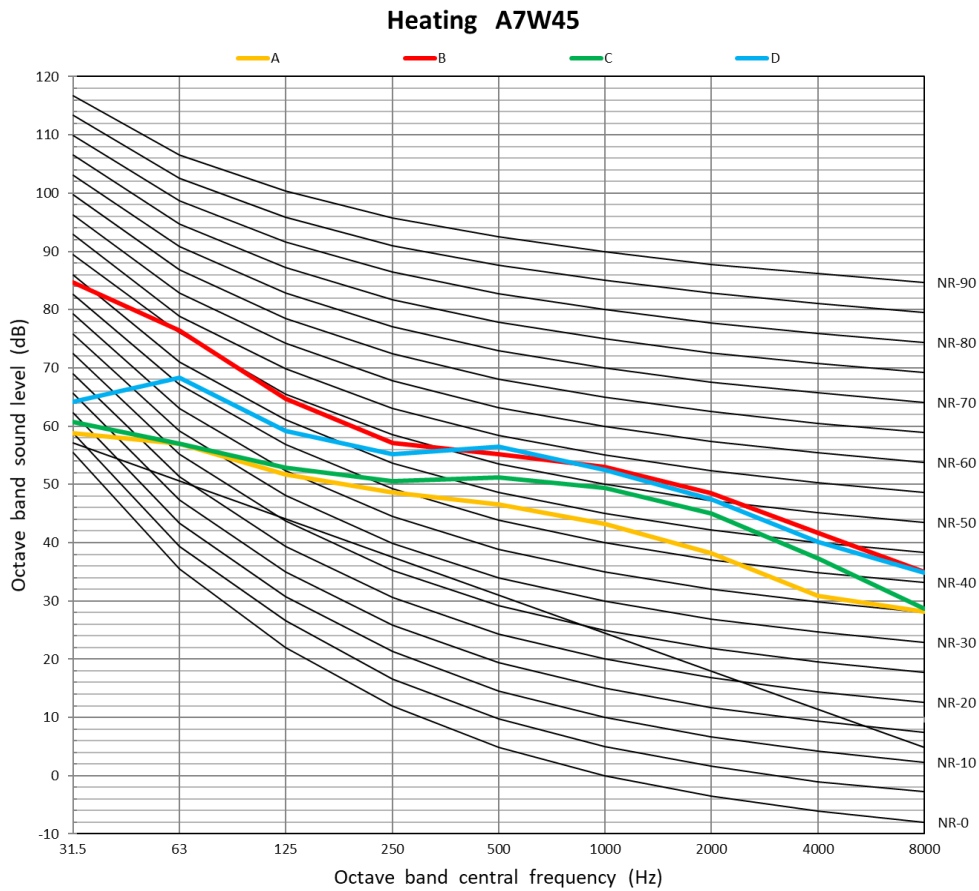

16kW 3Ph

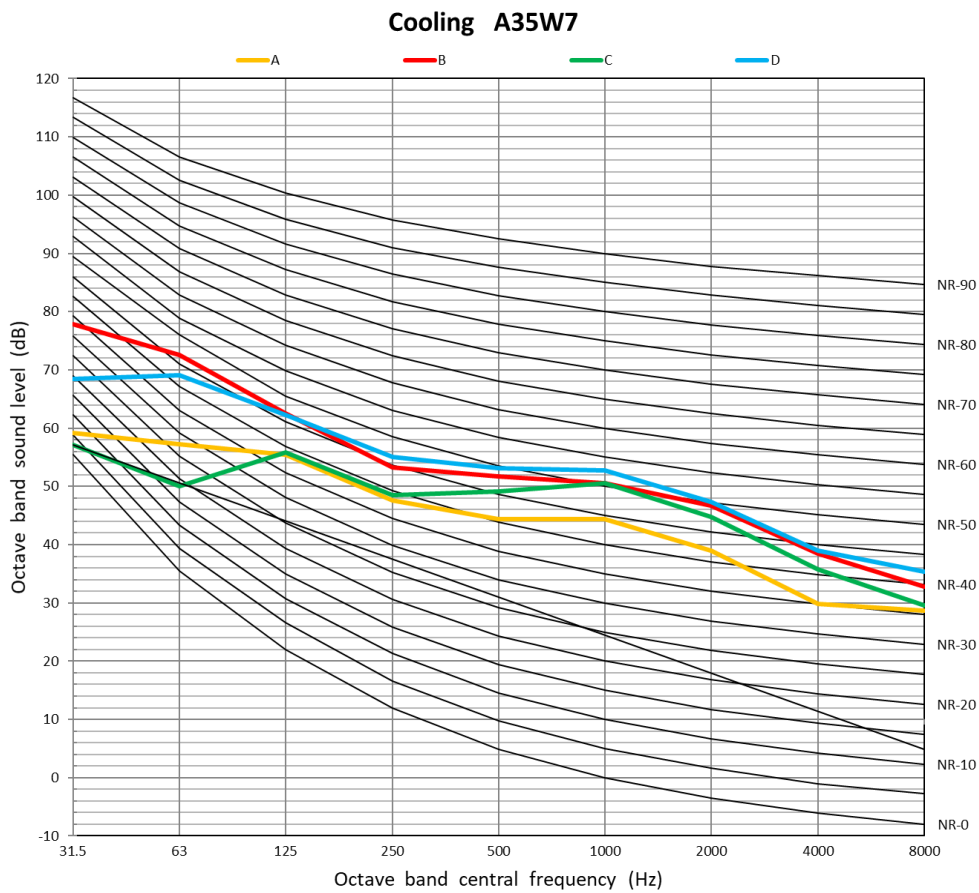
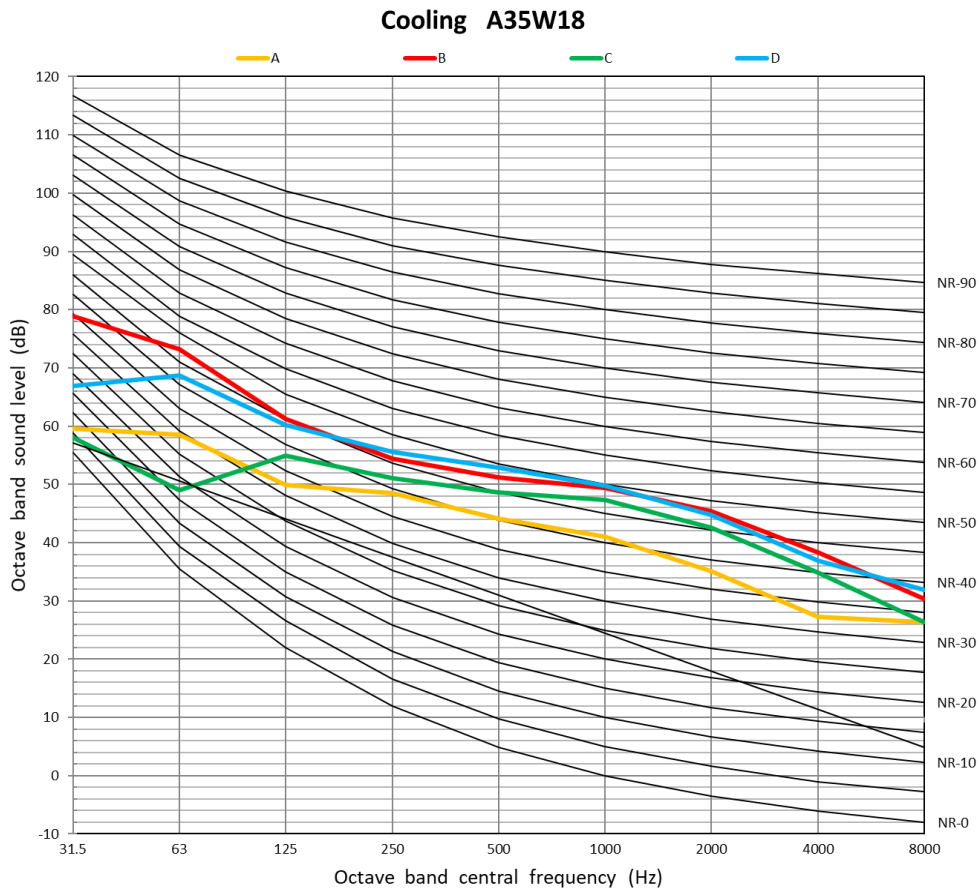

Midea Building Technologies Division
Midea Group

Add.: Midea Headquarters Building, 6 Midea Avenue, Shunde, Foshan, Guangdong, China

Postal code: 528311

mbt.midea.com / global.midea.com

Midea reserves the right to change the specifications of the product, and to withdraw or replace products without prior notification or public announcement. Midea is constantly developing and improving its products.

Please note that all the pictures in the document are for reference only. Actual products may vary.

