

CTRL-H0



IT	Manuale d'uso.....	2
EN	Operation Manual.....	15
FR	Manual d'utilisation.....	28
DE	Gebrauchsanweisung.....	41
ES	Manual de usuario.....	54

CTRL-H0

Pannello controllo touch per SISTEMA ORION

INDICE

1 PRECAUZIONI.....	2
2 INSTALLAZIONE.....	2
3 COLLEGAMENTO ELETTRICO.....	2
3.1 COLLEGAMENTO MODBUS.....	2
4 FUNZIONALITÀ.....	4
4.1 HOME PAGE.....	4
4.2 IMPOSTAZIONE LINGUA E NUMERO UNITÀ DEL SISTEMA.....	5
4.3 DESCRIZIONE FUNZIONALITÀ.....	7
4.4 CONFIGURAZIONE.....	8
4.4.1 RESET FILTRO.....	8
4.4.2 STATO UNITÀ.....	9
4.4.3 IMPOSTAZIONI DI SISTEMA.....	10
4.4.4 PASSWORD.....	10
4.4.5 IMPOSTAZIONI CONTROLLO.....	14

Leggere questo manuale attentamente prima di utilizzare il prodotto e conservarlo in un posto sicuro così da poterlo consultare all'occorrenza. Il prodotto è costruito a regola d'arte e nel rispetto delle normative vigenti in materia di apparecchiature elettriche e deve essere installato da personale tecnicamente qualificato. La ditta costruttrice non si assume responsabilità per danni a persone o cose derivanti dalla mancata osservanza delle norme contenute nel presente libretto.

1 PRECAUZIONI

- Assicurarsi che l'interruttore generale dell'impianto sia spento prima di qualsiasi operazione di installazione, manutenzione ordinaria o straordinaria o collegamento elettrico!
- L'installazione, la manutenzione e la risoluzione di anomalie del pannello di comando deve essere eseguita da un installatore autorizzato e in conformità alle leggi e ai regolamenti vigenti.
- Qualora si rilevi un'anomalia di funzionamento, scollegare il prodotto dalla rete elettrica e contattare immediatamente un tecnico qualificato.
- Questo apparecchio può essere utilizzato da bambini di età non inferiore ad 8 anni e da persone con ridotte capacità fisiche, sensoriali o mentali o con esperienza e conoscenze insufficienti, purché attentamente sorvegliate o istruite su come utilizzare in modo sicuro l'apparecchio e sui pericoli che ciò comporta. Assicurarsi che i bambini non giochino con l'apparecchio. Pulizia e manutenzione da parte dell'utente non devono essere eseguite da bambini senza supervisione.
- Il collegamento elettrico non corretto può recare danno al ventilatore e interferire con altri dispositivi elettronici.

2 INSTALLAZIONE

Fare riferimento al manuale d'installazione fornito nell'imballo del pannello di controllo oppure consultare il sito www.aerauliqa.it



3 COLLEGAMENTO ELETTRICO

Fare riferimento al manuale d'installazione fornito nell'imballo del pannello di controllo oppure consultare il sito www.aerauliqa.it



ATTENZIONE: Il pannello di controllo deve essere alimentato 24 VAC 50/60Hz con massimo carico 4VA oppure 12÷30VDC con massimo carico 2W.

3.1 COLLEGAMENTO MODBUS

- Utilizzare cavo twisted-pair
- Sezione cavo min. 24AWG (0,5mm)
- Massima lunghezza del cavo twisted-pair tra ciascun dispositivo del sistema: 30m

Se si desidera collegare al pannello di controllo più unità (**max 8**), il collegamento da eseguire deve avere un inizio (pannello di controllo) e una fine (ultima unità), come da immagine seguente.

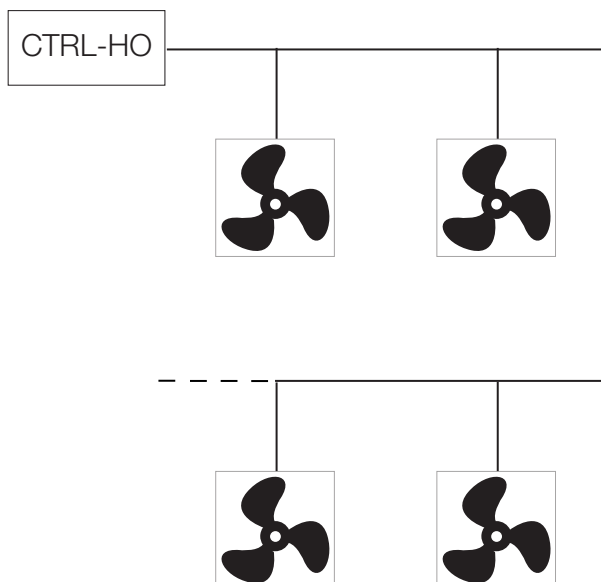

Se le unità non vengono collegate come da schema sopra riportato, potrebbe verificarsi un degrado del segnale di comunicazione e la rete potrebbe non funzionare correttamente.

⚠ Per eseguire le seguenti operazioni il pannello di controllo e l'unità devono essere disconnessi dall'alimentazione principale.

È raccomandato abilitare la resistenza di terminazione presente sul pannello di controllo e sull'ultima unità collegata alla linea Modbus come segue:

- Pannello di controllo: fare riferimento al manuale d'installazione fornito nell'imballo oppure consultare il sito www.aerauliqa.it



- Ultima unità ventilante: la resistenza di terminazione è attivabile tramite Dip Switch 4 posizionato sul circuito elettronico della base di supporto come segue:

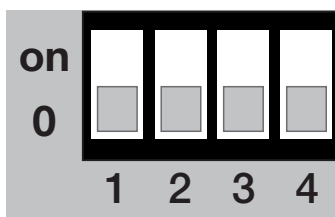
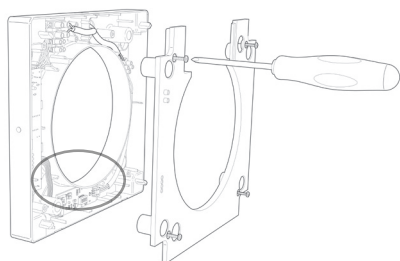

DIP SWITCH		
4	RESISTENZA DI TERMINAZIONE	
0	Resistenza di terminazione DISATTIVATA	default
on	Resistenza di terminazione ATTIVATA	

Tramite i Dip Switch 1-2-3 è possibile impostare l'indirizzo Modbus di ciascuna unità partendo dal numero 1.









DIP SWITCH				
INDIRIZZO	1	2	3	
1	0	0	0	default
2	0	0	on	
3	0	on	0	
4	0	on	on	
5	on	0	0	
6	on	0	on	
7	on	on	0	
8	on	on	on	









4 FUNZIONALITÀ

4.1 HOME PAGE

Attenzione: Il CTRL-H0 è il pannello di controllo remoto (master) che permette di comandare contemporaneamente tutte le unità ORION (slave) collegate. Non comanda le unità singolarmente.



Tasto	Descrizione																		
	Selezione modalità "On" (le unità di ventilazione sono in funzione) oppure "Off" (le unità di ventilazione non sono in funzione)																		
	Accesso alla schermata Configurazione (paragrafo 4.4)																		
	Regolazione velocità: toccando i simboli  oppure  si aumenta o diminuisce la velocità di tutte le unità collegate. Sul display appare il numero della velocità selezionata come da seguente tabella: <table border="1" data-bbox="225 1227 667 1496"><thead><tr><th>VELOCITÀ</th><th>ORION 100</th><th>ORION 150</th></tr></thead><tbody><tr><td>1</td><td>10 m³/h</td><td>20 m³/h</td></tr><tr><td>2</td><td>14 m³/h</td><td>30 m³/h</td></tr><tr><td>3</td><td>17 m³/h</td><td>40 m³/h</td></tr><tr><td>4</td><td>21 m³/h</td><td>50 m³/h</td></tr><tr><td>5</td><td>25 m³/h</td><td>60 m³/h</td></tr></tbody></table>	VELOCITÀ	ORION 100	ORION 150	1	10 m³/h	20 m³/h	2	14 m³/h	30 m³/h	3	17 m³/h	40 m³/h	4	21 m³/h	50 m³/h	5	25 m³/h	60 m³/h
VELOCITÀ	ORION 100	ORION 150																	
1	10 m³/h	20 m³/h																	
2	14 m³/h	30 m³/h																	
3	17 m³/h	40 m³/h																	
4	21 m³/h	50 m³/h																	
5	25 m³/h	60 m³/h																	
Free cooling	Toccando la scritta sul display si attiva manualmente la funzione free cooling (paragrafo 4.3): quando attiva la scritta Free Cooling appare sul display																		
	Modalità Comfort/Efficiency: toccando il tasto si seleziona la modalità Comfort oppure Efficiency (paragrafo 4.3). La scritta Comfort o Efficiency appare sul display																		
	Boost: toccando il tasto si attiva la modalità Boost. L'icona  appare sul display. Il tasto permette di selezionare anche la temporizzazione della funzione Boost (10-20-30 minuti) oppure di disattivarla (paragrafo 4.3)																		

Icona	Descrizione
	Allarme Filtro: il simbolo  appare quando è necessario eseguire la manutenzione dei filtri (paragrafo 4.3)
	Controllo smart umidità: il simbolo  appare se il sensore di umidità è attivo (paragrafo 4.3)
	Antigelo: il simbolo  appare se la funzione antigelo è attiva (paragrafo 4.3)
 Modbus	Allarme Modbus: il simbolo  appare se una o più unità non riescono a comunicare sulla rete Modbus. Accedere alla schermata "Stato dell'unità" (paragrafo 4.4.2)

4.2 IMPOSTAZIONE LINGUA E NUMERO UNITÀ DEL SISTEMA

Quando alimentato per la prima volta, il CTRL-HO mostra la seguente schermata:



Tasto	Descrizione
Lingua Set	Selezione della lingua (italiano, inglese, francese, spagnolo o tedesco)
Unità Set	Impostazione del numero di unità del sistema (fino a massimo 8)
Ok	Consenso per accedere alla schermata successiva

Toccando il tasto Ok si accede alla seguente schermata:

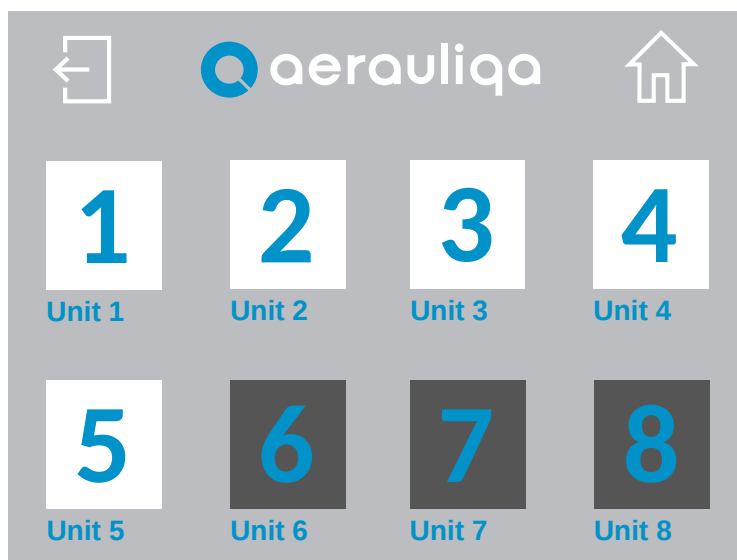







Tasto	Descrizione
	Ritorno alla schermata precedente
	Ritorno alla schermata Home page
1	Selezione dell'unità collegata

Toccando il numero si accede alla seguente schermata:



Tasto	Descrizione
	Ritorno alla schermata precedente
	Ritorno alla schermata Home page
Unit 1	Toccando la scritta è possibile attribuire un nome all'unità
Set	Selezione della direzione del flusso dell'aria (estrazione o immissione) alla prima accensione dell'unità, quando l'unità è in modalità Boost e in modalità Free Cooling
	Toccando il simbolo si passa alla schermata relativa all'unità successiva
Modbus	Allarme Modbus: il simbolo appare se una o più unità non riescono a comunicare sulla rete Modbus. Accedere alla schermata "Stato dell'unità" (paragrafo 4.4.2)



4.3 DESCRIZIONE FUNZIONALITÀ

Funzionalità	Descrizione	Tasto comando	Icona/scritta su display
Comfort	Le unità massimizzano il comfort termico e acustico. Il tempo di inversione varia automaticamente tra 40÷120 secondi, grazie alla sonda di temperatura integrata. Il primo ciclo temporale è di 70 secondi, poi varia automaticamente a seconda delle condizioni rilevate. La prima unità che inverte il flusso determina l'inversione su tutto il sistema.		Comfort
Efficiency	Le unità massimizzano l'efficienza termica. Il tempo di inversione è fisso a 70 secondi.		Efficiency
Free Cooling	Le unità funzionano in sola estrazione o in sola immissione per un periodo di 30 minuti, per evitare il recupero di calore quando non richiesto. Per selezionare la direzione del flusso dell'aria di ciascuna unità fare riferimento al paragrafo 4.2	-	-
	Free cooling manuale: può essere attivato tramite apposito tasto sul display.	Free cooling	Free Cooling
	Free cooling automatico: per l'impostazione fare riferimento al paragrafo 4.4.5	Auto free cooling	Auto free cooling
Boost	Le unità funzionano alla velocità 5 (massima) per un periodo di tempo selezionabile tramite il relativo tasto (10-20-30 minuti), per poi tornare alla modalità/velocità precedentemente impostata. Per selezionare la direzione del flusso dell'aria di ciascuna unità fare riferimento al paragrafo 4.2.		
Reset filtro	Ogni 3 mesi circa, sul display appare la relativa icona che avvisa l'utente di effettuare la manutenzione dei filtri su tutte le unità. Per resettare la temporizzazione fare riferimento al paragrafo 4.4.1	-	
Controllo smart dell'umidità	Quando la sonda di umidità di un'unità rileva una variazione repentina del tasso di umidità relativa, la velocità viene incrementata, su tutte le unità collegate, automaticamente al livello superiore rispetto a quella scelta. Dopo 10 minuti dall'ultima variazione repentina rilevata dalla stessa unità, tutte le unità ritornano a funzionare alla velocità selezionata tramite pannello di controllo. Il controllo di umidità è attivo solo se la direzione del flusso d'aria delle unità è alternata o in estrazione: se è stata selezionata la velocità 5, l'intervento della sonda di umidità non genera variazioni. Per disabilitare questa funzione su tutte le unità vedere paragrafo 4.4.5	-	
Night Mode	Se attivo, dalle ore 20 alle ore 8 (non modificabile) la funzione controllo umidità viene disabilitata su tutte le unità collegate. Per abilitare/disabilitare questa funzione vedere paragrafo 4.4.5	-	-
Antigelo	Questa funzionalità si riferisce alla singola unità e previene che aria eccessivamente fredda attraversi lo scambiatore ceramico, con il rischio di danneggiarlo. Quando interviene, l'unità funziona in sola estrazione alla velocità 1 per 30 minuti.	-	

4.4 CONFIGURAZIONE



Toccando il tasto  si accede alla seguente schermata:



Tasto	Descrizione
	Ritorno alla schermata precedente
	Ritorno alla schermata Home page
Numero di unità	Impostazione numero di unità collegate (paragrafo 4.2)
Impostazioni unità	Impostazione direzione flusso dell'aria di ciascuna unità (paragrafo 4.2)
Reset filtro	Ripristino allarme filtro e temporizzazione (paragrafo 4.4.1)
Stato unità	Informazioni relative allo stato di ciascuna unità (paragrafo 4.4.2)
Impostazioni di sistema	Impostazione lingua, buzzer, backlight e password (paragrafo 4.4.3)
Impostazioni controllo	Impostazione free cooling, night mode e controllo umidità (paragrafo 4.4.5)

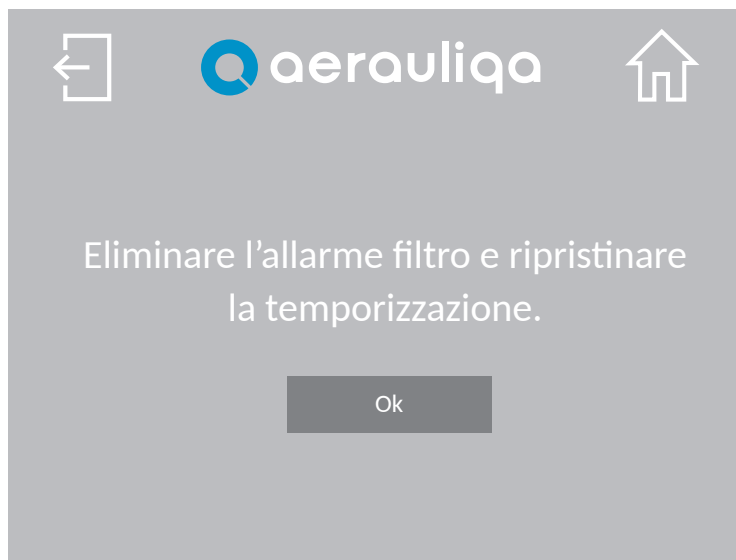

4.4.1 RESET FILTRO



Tasto	Descrizione
	Ritorno alla schermata precedente
	Ritorno alla schermata Home page
Ok	Ripristino allarme/temporizzazione e ritorno alla schermata precedente

4.4.2 STATO UNITÀ



Tasto	Descrizione
	Ritorno alla schermata precedente
	Ritorno alla schermata Home page
	Selezione del numero dell'unità a cui la schermata fa riferimento

Se necessario seguire le istruzioni che appaiono sul display per risolvere il problema oppure contattare l'assistenza tecnica.

4.4.3 IMPOSTAZIONI DI SISTEMA



Tasto	Descrizione
	Ritorno alla schermata precedente
	Ritorno alla schermata Home page
Firmware	Riferimento del firmware caricato sul pannello di controllo
Lingua Set	Selezione della lingua (italiano, inglese, francese, spagnolo o tedesco)
Buzzer Set	Impostazione segnale acustico: possibilità di scelta tra "On" oppure "Off"
Backlight Set	Impostazione accensione schermo: possibilità di scelta tra "sempre acceso" oppure "temporizzato"
Password	Impostazione della password (paragrafo 4.4.4)

4.4.4 PASSWORD

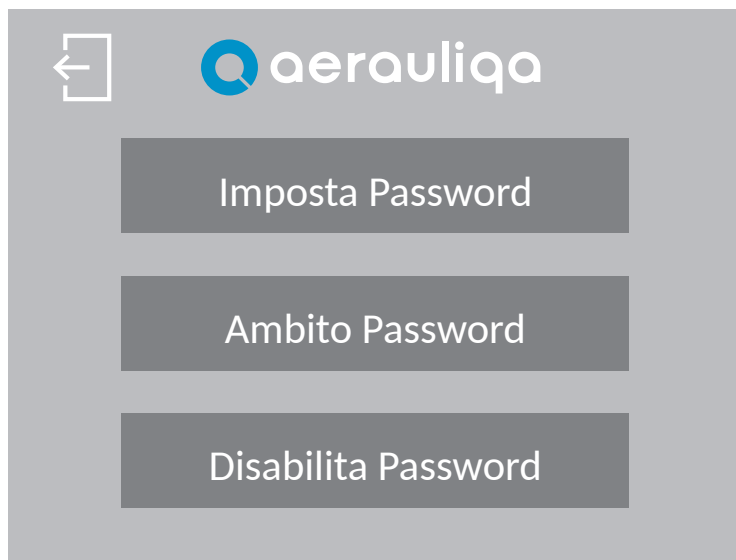

Tasto	Descrizione
	Ritorno alla schermata precedente
Imposta	Impostazione della password (inserire solo numeri, da 1 a 9999)
Ambito	Scegli se proteggere "Tutte le pagine" oppure solo "Pagine di configurazione".
Disabilita	Disabilita la password

Toccando il tasto "Imposta Password", viene visualizzata la seguente schermata:



Tasto	Descrizione
	Ritorno alla schermata precedente
0	Immettere la password due volte
Conferma	Toccare per confermare/abilitare la password

Toccando il tasto "Ambito Password", viene visualizzata la seguente schermata:



Tasto	Descrizione
	Ritorno alla schermata precedente
Set	Selezione delle pagine da proteggere tra "Tutte le pagine" o "Pagine di configurazione"
Conferma	Toccare per confermare

Se la password è abilitata, quando necessario, viene visualizzata la seguente schermata.

Inserire la password corretta per continuare.

Se la schermata non cambia, verificare la password e riprovare.

Se la password è stata dimenticata, contattare il servizio clienti.

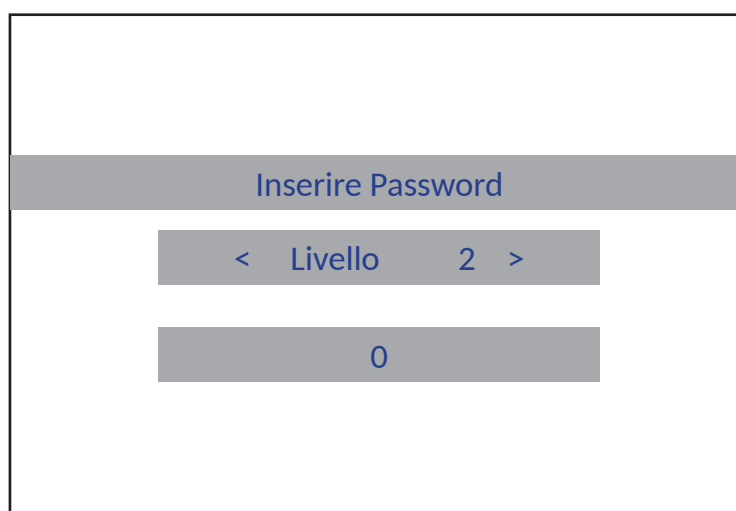



Toccando il tasto "Disabilita Password", viene visualizzata la seguente schermata:

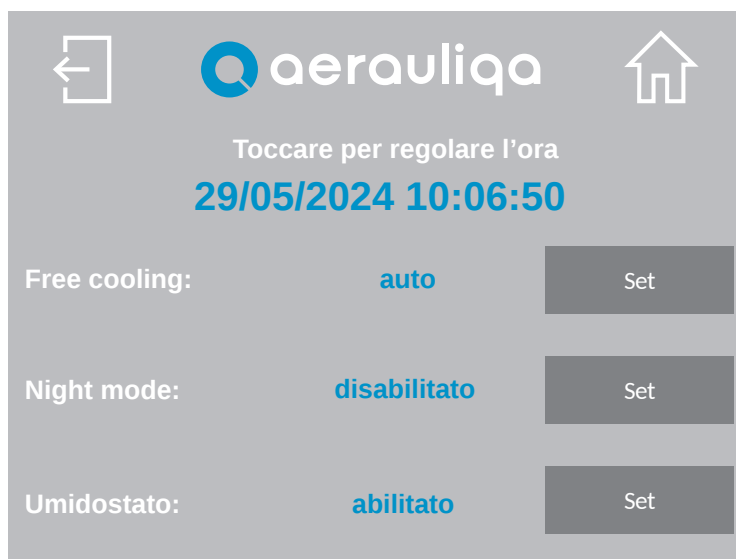

Tasto	Descrizione
	Ritorno alla schermata precedente
0	Inserire la password
Conferma	Toccare per disabilitare la password

4.4.5 IMPOSTAZIONI CONTROLLO



Tasto	Descrizione
	Ritorno alla schermata precedente
	Ritorno alla schermata Home page
Free cooling Set	Selezione Free Cooling "manuale" oppure "auto" (paragrafo 4.3)
Night mode Set	Abilitazione/Disabilitazione Night mode (paragrafo 4.3)
Umidostato Set	Abilitazione/Disabilitazione controllo smart umidità (paragrafo 4.3)

CTRL-H0

Control panel for ORION SYSTEM

INDEX

1 PRECAUTIONS.....	15
2 INSTALLATION.....	15
3 WIRING DIAGRAM.....	15
3.1 MODBUS CONNECTION.....	15
4 OPERATION.....	17
4.1 HOME PAGE.....	17
4.2 SETTING OF THE LANGUAGE AND NUMBER OF VENTILATION UNITS.....	18
4.3 OPERATION DESCRIPTION.....	20
4.4 CONFIGURATION.....	21
4.4.1 FILTER RESET.....	22
4.4.2 UNIT STATUS.....	22
4.4.3 SYSTEM SETTINGS.....	23
4.4.4 PASSWORD.....	24
4.4.5 CONTROLLER SETTING.....	27

Read this manual carefully before using the product and keep it in a safe place for reference. This product was constructed up to standard and in compliance with regulations relating to electrical equipment and must be installed by technically qualified personnel. The manufacturer assumes no responsibility for damage to persons or property resulting from failure to observe the regulations contained in this booklet.

1 PRECAUTIONS

- Make sure that the mains supply to the unit is disconnected before performing any installation, service, maintenance or electrical work!
- The installation and service of the unit and complete ventilation system must be performed by an authorized installer and in accordance with local rules and regulations.
- If any abnormality in operation is detected, disconnect the device from the mains supply and contact a qualified technician immediately.
- This appliance can be used by children aged from 8 years and above and persons with reduced physical, sensory or mental capabilities or lack of experience and knowledge if they have been given supervision or instruction concerning use of the appliance in a safe way and understand the hazards involved. Children shall not play with the appliance. Cleaning and user maintenance shall not be made by children without supervision.
- A wrong electrical wiring can cause damage to the fan and interfere with other electronic devices.

2 INSTALLATION

Refer to the manual supplied in the control panel box or consult the website www.aerauliqa.com



3 WIRING DIAGRAM

Refer to the manual supplied in the control panel box or consult the website www.aerauliqa.com



ATTENTION: The control panel must be powered 24 VAC 50/60Hz with maximum load 4VA or 12÷30VDC with maximum load 2W.

3.1 MODBUS CONNECTION

- Use twisted-pair cable type
- Minimum 24AWG (0,5mm) cable cross section
- Max length of the twisted-pair cable between each device of the network: 30m

If more fans (**up to 8**) need to be connected to the control panel, the connection must have a beginning (control panel) and an end (last unit), as shown in the picture below:

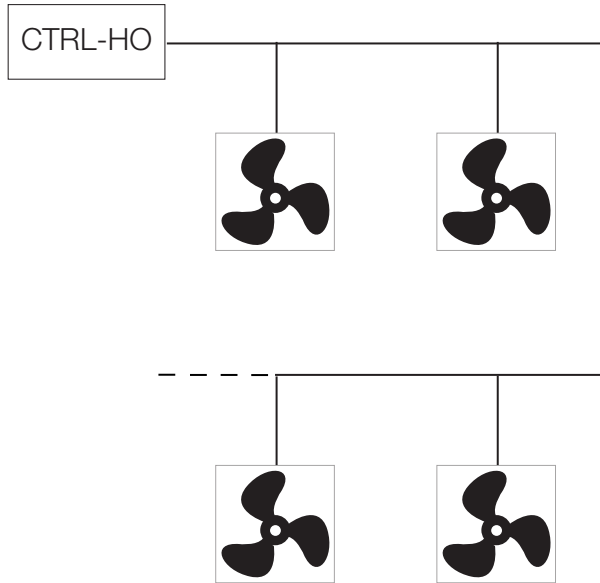

If the units are not connected as per the diagram above, a degradation of the communication signal may occur and the network may not function properly.

⚠ Before carrying out the following operations, the control panel and the unit must be disconnected from the main power supply.

It is recommended to enable the termination resistor on the control panel and on the last unit connected to the Modbus line as follows:

- Control panel: refer to the installation manual supplied in the box or consult www.aerauliqa.com.



- Last ventilation unit: the termination resistor can be activated via Dip Switch 4 located on the electronic circuit of the support base as follows:

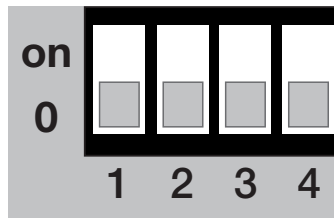
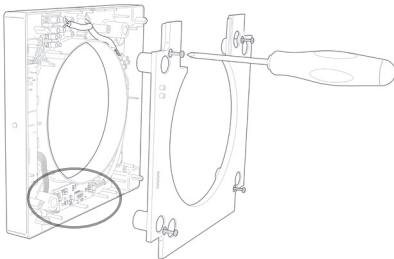

DIP SWITCH		
4	TERMINATION RESISTOR	
0	Terminating resistor DEACTIVATED	default
on	Terminating resistor ACTIVATED	

Using Dip Switches 1-2-3 it is possible to set the Modbus address of each unit starting with number 1.









DIP SWITCH				
ADDRESS	1	2	3	
1	0	0	0	default
2	0	0	on	
3	0	on	0	
4	0	on	on	
5	on	0	0	
6	on	0	on	
7	on	on	0	
8	on	on	on	









4 OPERATION

4.1 HOME PAGE

Attention: The CTRL-HO is the remote control panel (master) which allows all connected ORION units (slaves) to be controlled simultaneously. It does not control the units individually.



Button	Description																		
	Mode selection “On” (ventilation units are running) or “Off” (ventilation units are not running).																		
	Access to Setting page (paragraph 4.4)																		
	Speed setting: Touching the symbols  or  the speed of the all connected units increases or decreases. The display shows the number of the selected speed according to the following table: <table border="1" data-bbox="223 1198 662 1467"> <thead> <tr> <th>SPEED</th> <th>ORION 100</th> <th>ORION 150</th> </tr> </thead> <tbody> <tr> <td>1</td> <td>10 m³/h</td> <td>20 m³/h</td> </tr> <tr> <td>2</td> <td>14 m³/h</td> <td>30 m³/h</td> </tr> <tr> <td>3</td> <td>17 m³/h</td> <td>40 m³/h</td> </tr> <tr> <td>4</td> <td>21 m³/h</td> <td>50 m³/h</td> </tr> <tr> <td>5</td> <td>25 m³/h</td> <td>60 m³/h</td> </tr> </tbody> </table>	SPEED	ORION 100	ORION 150	1	10 m ³ /h	20 m ³ /h	2	14 m ³ /h	30 m ³ /h	3	17 m ³ /h	40 m ³ /h	4	21 m ³ /h	50 m ³ /h	5	25 m ³ /h	60 m ³ /h
SPEED	ORION 100	ORION 150																	
1	10 m ³ /h	20 m ³ /h																	
2	14 m ³ /h	30 m ³ /h																	
3	17 m ³ /h	40 m ³ /h																	
4	21 m ³ /h	50 m ³ /h																	
5	25 m ³ /h	60 m ³ /h																	
Free cooling	Touching the text on the display the free cooling function is manually activated (paragraph 4.3): when activated “Free Cooling” is displayed.																		
	Comfort/Efficiency mode: touch the button to select Comfort or Efficiency mode (paragraph 4.3). “Comfort” or “Efficiency” is displayed.																		
	Boost: touching the button the Boost mode is activated. The  icon is displayed. The button also allows to select the timing of the Boost function (10-20-30 minutes) or to deactivate it (paragraph 4.3).																		

Icon	Description
	Filter Alarm: the symbol  is displayed when filter maintenance is required (paragraph 4.3)
	Smart humidity control: the symbol  is displayed if the humidity sensor is active (paragraph 4.3)
	Antifrost: the symbol  is displayed if the antifrost function is active (paragraph 4.3)
 Modbus	Modbus alarm: the symbol  is displayed if one or more units fail to communicate on the Modbus network. Access the “Unit Status” screen (paragraph 4.4.2)

4.2 SETTING OF THE LANGUAGE AND NUMBER OF VENTILATION UNITS

When the control panel is powered ON for the first time, the following screen is displayed:

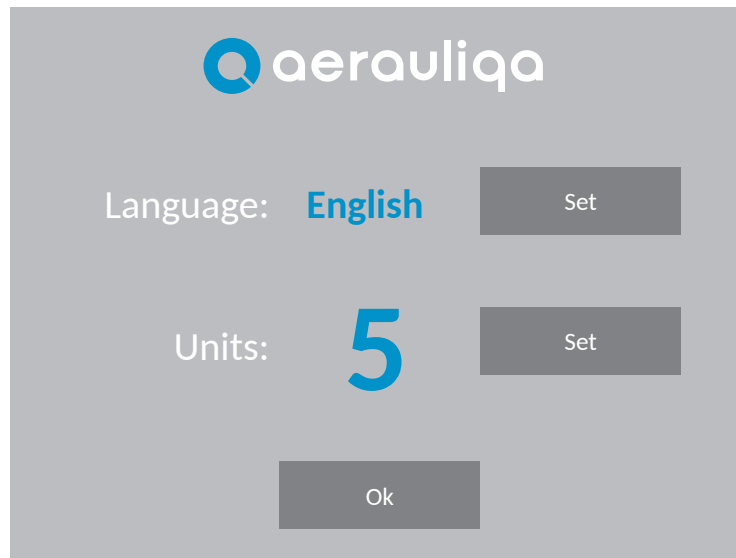

Button	Description
Language Set	Language selection (Italian, English, French, Spanish or German)
Unit Set	Setting of the number of units of the system (max 8 units)
Ok	Confirm and access to the next screen

Touching the OK button the following screen is displayed:

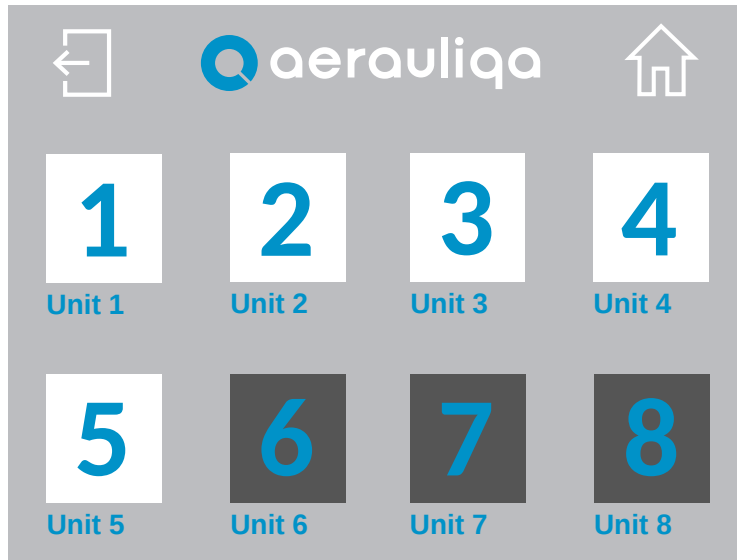





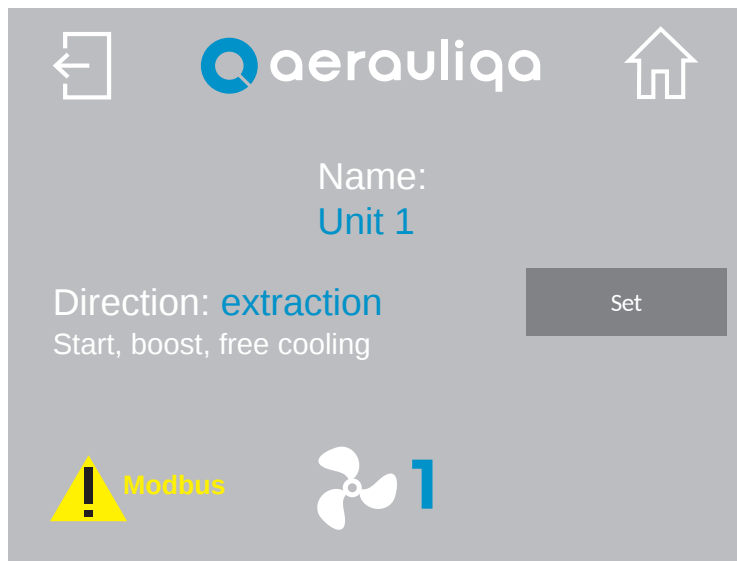

Button	Description
	Back to the previous screen
	Back to the Home Page
	Selection of the connected unit

Touching the number the following screen is displayed:



Button	Description
	Back to the previous screen
	Back to the Home Page
Unit 1	Touching the text, a name can be assigned to the unit
Set	Selection of the airflow direction (extract or intake) when the unit is first switched on, when the unit is in Boost mode and in Free Cooling mode
	Touching the symbol switches to the next unit screen
	Modbus alarm: the symbol is displayed if one or more units fail to communicate on the Modbus network. Access the "Unit Status" screen (paragraph 4.4.2)



4.3 OPERATION DESCRIPTION

Operation	Description	Button	Icon/text on display
Comfort	The units maximise the thermal and acoustic comfort. The inversion time varies automatically between 40÷120 seconds, thanks to the integrated temperature sensor. The first time cycle is 70 seconds, then it varies automatically depending on the detected conditions. The first unit reversing the flow causes the reversal of the whole system.		Comfort
Efficiency	The units maximise the thermal efficiency. The inversion time is fixed at 70 seconds.		Efficiency
Free Cooling	The units operate in extract-only or intake-only for 30 minutes to avoid heat recovery when not required. To select the airflow direction of each unit refer to paragraph 4.2.	-	-
	Manual free cooling: can be activated via dedicated button on the display.	Free cooling	Free Cooling
	Automatic free cooling: refer to paragraph 4.4.5 for setting	Auto free cooling	Auto free cooling
Boost	The units operate at speed 5 (maximum) for a period of time selectable via the dedicated button (10-20-30 minutes), and then return to the previously set mode/speed. To select the airflow direction of each unit refer to paragraph 4.2.		
Filter reset	Approximately every 3 months, the relevant icon is displayed, advising the user to perform filter maintenance on all units. To reset the timing refer to paragraph 4.4.1	-	
Smart humidity control	When the humidity sensor of a unit detects a quick variation in the relative humidity level, the speed is automatically increased to the higher speed on all the connected units. After 10 minutes from the last quick variation detected by the same unit, all units return to operate at the speed selected via the control panel. The smart humidity control is only active if the airflow direction of the units is set on alternate or extraction: if speed 5 has been selected, the intervention of the humidity probe does not generate variations. To disable this function on all units refer to paragraph 4.4.5	-	
Night Mode	If active, from 8 p.m. to 8 a.m. (cannot be changed) the smart humidity control function is disabled on all connected units. To enable/disable this function refer to paragraph 4.4.5	-	-
Antifrost	This feature refers to each individual unit and prevents excessively cold air from passing through the ceramic exchanger, with the risk of damaging it. When activated, the unit operates in extract mode at speed 1 for 30 minutes.	-	

4.4 CONFIGURATION

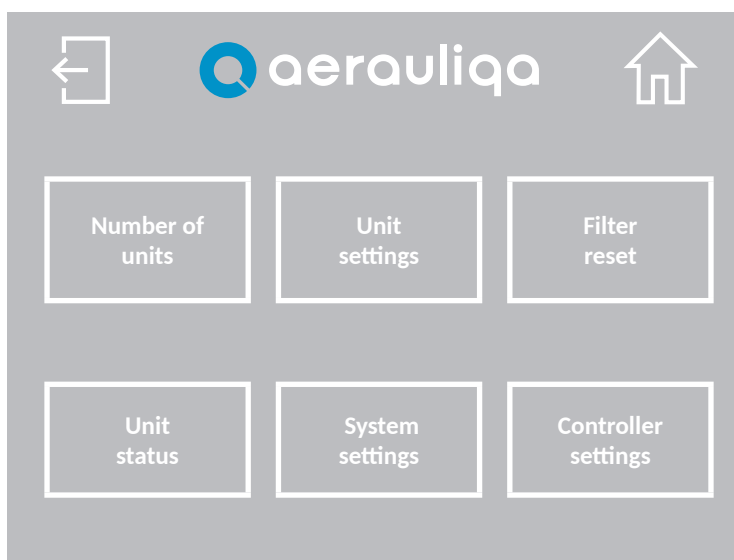

Touching the button  the following screen is displayed:



Button	Description
	Back to the previous screen
	Back to the Home Page
Number of units	Setting the number of wired units (paragraph 4.2)
Unit setting	Setting the airflow direction of each unit (paragraph 4.2)
Filter reset	Resetting of Filter Alarm and Timing (paragraph 4.4.1)
Unit status	Information on the status of each unit (paragraph 4.4.2)
System settings	Setting of the language, buzzer, backlight and password (paragraph 4.4.3)
Controller settings	Setting of the free cooling, night mode and smart humidity control (paragraph 4.4.5)



4.4.1 FILTER RESET

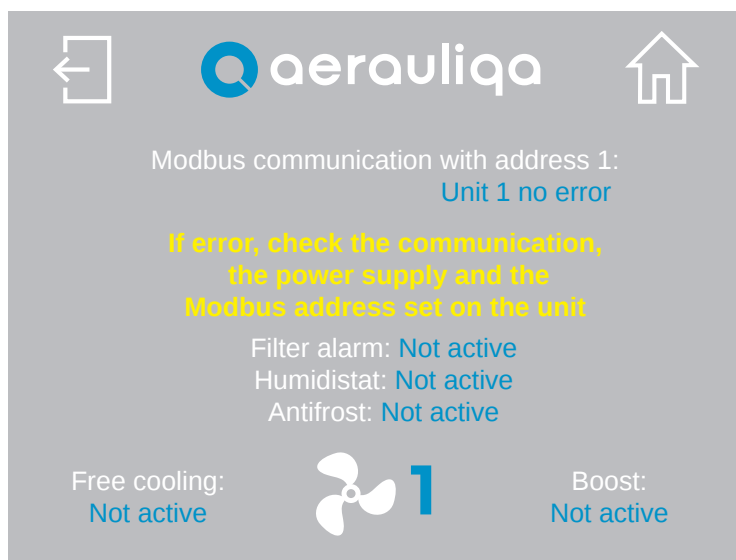

Button	Description
	Back to the previous screen
	Back to the Home Page
Ok	Alarm/Timer reset and return to previous screen

4.4.2 UNIT STATUS





Button	Description
	Back to the previous screen
	Back to the Home Page
	Selection of the unit number to which the screen refers

If necessary, follow the instructions on the display to solve the problem or contact technical support.

4.4.3 SYSTEM SETTINGS



Button	Description
	Back to the previous screen
	Back to the Home Page
Firmware	Firmware reference loaded on the control panel
Language Set	Language selection (Italian, English, French, Spanish or German)
Buzzer Set	Beep setting: choose between “On” or “Off”.
Backlight Set	Backlight set: choose between “always on” or “time-controlled”.
Password	Password setting (paragraph 4.4.4)

4.4.4 PASSWORD



Button	Description
	Back to the previous screen
Set	Password setting (enter numbers only, from 1 to 9999)
Scope	Choose whether to protect “All pages” or only “Setting pages”.
Disable	Touch to disable the password

Touching the “Set Password button”, the following screen is displayed:



Button	Description
	Back to the previous screen
0	Enter password twice
Confirm	Touch to confirm/enable the password

Touching the “Password Scope” button, the following screen is displayed:

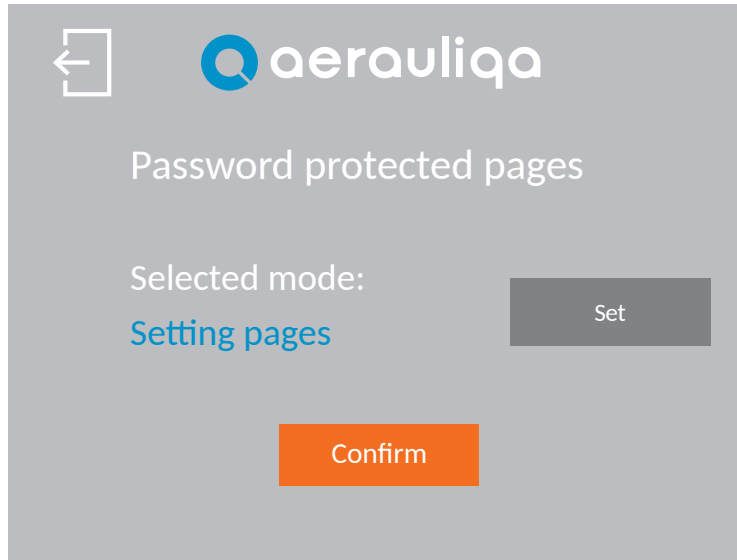

Button	Description
	Back to previous screen
Set	Selection of pages to be protected between “All pages” or “Setting pages”.
Confirm	Touch to confirm

If the password is enabled, when needed, the following screen is displayed.

Enter the correct password to continue.

If the screen does not change, verify password and try again.

If the password has been forgotten, contact the customer service.

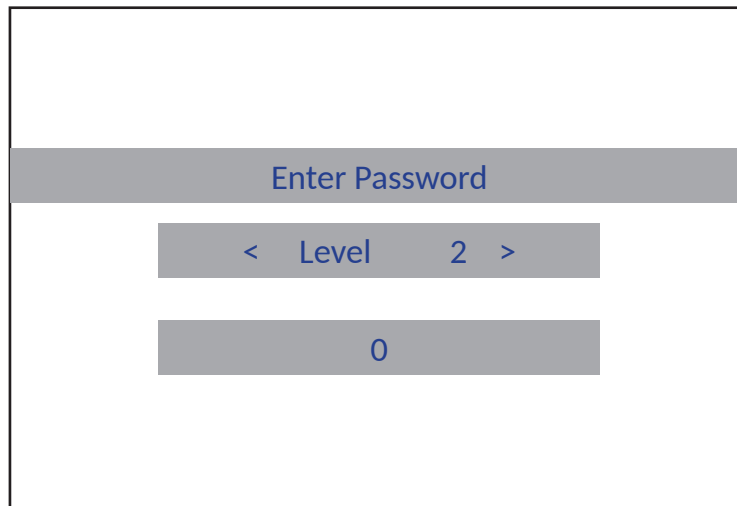

Touching the “Disable Password” button, the following screen is displayed:

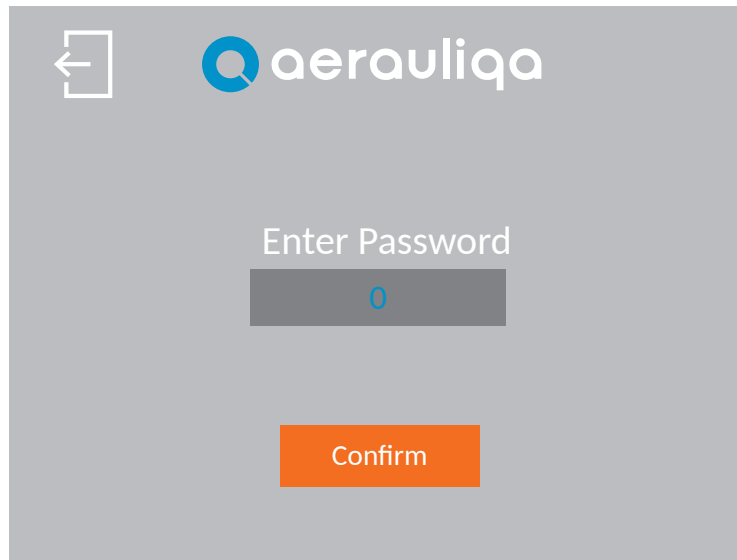

Button	Description
	Back to the previous screen
0	Enter password
Confirm	Touch to disable password

4.4.5 CONTROLLER SETTING

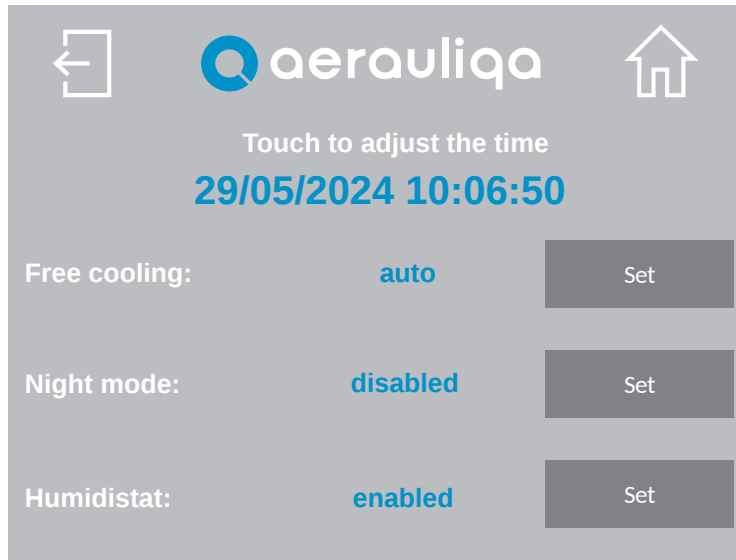

Button	Description
	Back to the previous screen
	Back to the Home Page
Free cooling Set	Choose between Free Cooling “manual” or “auto” (paragraph 4.3)
Night mode Set	Enabling/Disabling of the Night mode (paragraph 4.3)
Humidistat Set	Enabling/Disabling of the smart humidity control (paragraph 4.3)

CTRL-H0

Panneau de contrôle tactile pour le système ORION

INDEX

1 PRÉCAUTIONS.....	28
2 INSTALLATION.....	28
3 CONNEXION ÉLECTRIQUE.....	28
3.1 CONNEXION MODBUS.....	28
4 FONCTIONALITÉ.....	30
4.1 PAGE D'ACCUEIL.....	30
4.2 RÉGLAGE DE LA LANGUE ET DU NOMBRE D'UNITÉS DE VENTILATION.....	31
4.3 DESCRIPTION DES CARACTÉRISTIQUES.....	33
4.4 CONFIGURATION.....	34
4.4.1 RÉINITIALISER FILTRE.....	34
4.4.2 STATUT DE L'UNITÉ.....	35
4.4.3 PARAMÈTRES DU SYSTÈME.....	36
4.4.4 MOT DE PASSE.....	37
4.4.5 PARAMÈTRES DE CONTRÔLEUR.....	40

Lisez attentivement ce manuel avant d'utiliser le produit et conservez-le dans un endroit sûr afin de pouvoir vous y référer en cas de besoin. Le produit est construit dans les règles de l'art et en conformité avec les réglementations en vigueur pour le matériel électrique et doit être installé par du personnel techniquement qualifié. Le fabricant décline toute responsabilité en cas de dommages corporels ou matériels résultant du non-respect des prescriptions contenues dans ce livret.

1 PRÉCAUTIONS

- Veillez à ce que l'interrupteur principal du système soit mis hors tension avant toute installation, tout entretien ordinaire ou extraordinaire ou tout raccordement électrique !
- L'installation, l'entretien et le dépannage du panneau de contrôle doivent être effectués par un installateur agréé et conformément aux lois et règlements en vigueur.
- Si un dysfonctionnement est détecté, débranchez l'appareil et contactez immédiatement un technicien qualifié.
- Cet appareil peut être utilisé par des enfants âgés d'au moins 8 ans et par des personnes dont les capacités physiques, sensorielles ou mentales sont réduites ou dont l'expérience et les connaissances sont insuffisantes, à condition qu'elles soient soigneusement surveillées ou instruites sur la manière d'utiliser l'appareil en toute sécurité et sur les dangers qu'il présente. Veillez à ce que les enfants ne jouent pas avec l'appareil. Le nettoyage et l'entretien par l'utilisateur ne doivent pas être effectués par des enfants sans surveillance.
- Un mauvais branchement électrique peut endommager le ventilateur et interférer avec d'autres appareils électroniques.

2 INSTALLATION

Veillez consulter le manuel d'installation fourni dans l'emballage du panneau de contrôle ou visitez le site www.aerauliqa.com.



3 CONNEXION ÉLECTRIQUE

Veillez consulter le manuel d'installation fourni dans l'emballage du panneau de contrôle ou visitez le site www.aerauliqa.com.



ATTENTION : le panneau de contrôle doit être alimenté en 24 VAC 50/60Hz avec une charge maximale de 4VA ou en 12÷30VDC avec une charge maximale de 2W.

3.1 CONNEXION MODBUS

- Utiliser un câble à paires torsadées
- Section de câble min. 24AWG (0,5mm)
- Longueur maximale du câble à paires torsadées entre chaque appareil du système : 30 mètres

Si plus d'une unité (**max. 8**) doit être connectée au panneau de contrôle, la connexion à effectuer doit avoir un début (panneau de contrôle) et une fin (dernière unité), comme le montre l'image suivante.

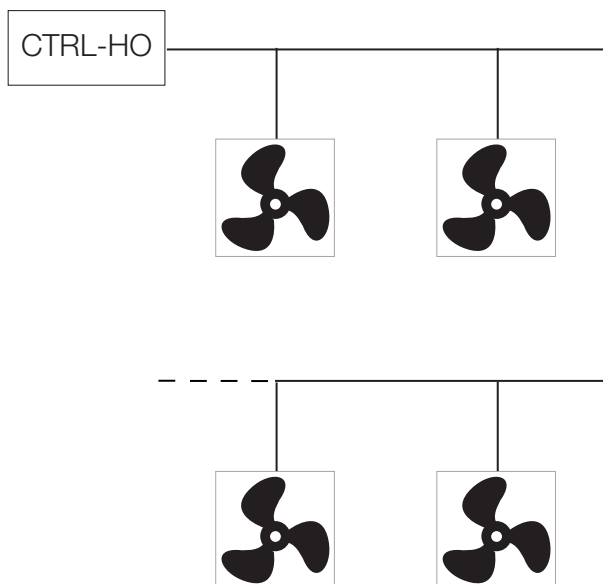

Si les unités ne sont pas connectées conformément au schéma ci-dessus, une dégradation du signal de communication peut se produire et le réseau peut ne pas fonctionner correctement.

⚠ Pour réaliser les opérations suivantes le panneau et l'appareil doivent être déconnectés de l'alimentation principale.

Il est recommandé d'activer la résistance de terminaison sur le panneau de contrôle et sur la dernière unité connectée à la ligne Modbus de la manière suivante :

- Panneau de contrôle : se référer au manuel d'installation fourni dans l'emballage ou consulter le site www.aerauliqa.com



- Dernière unité de ventilation : la résistance de terminaison peut être activée via le Dip Switch 4 situé sur le circuit électronique de la base de support de la manière suivante :

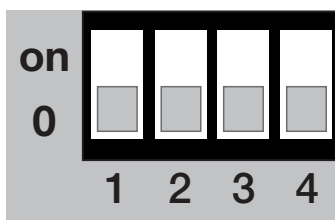
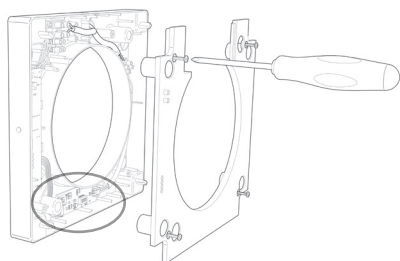

DIP SWITCH		
4	RÉSISTANCE DE TERMINAISON	
0	Résistance de terminaison DÉSACTIVÉE	default
on	Résistance de terminaison ACTIVÉE	

En utilisant les Dip Switches 1-2-3, il est possible de régler l'adresse Modbus de chaque unité en commençant par le numéro 1.







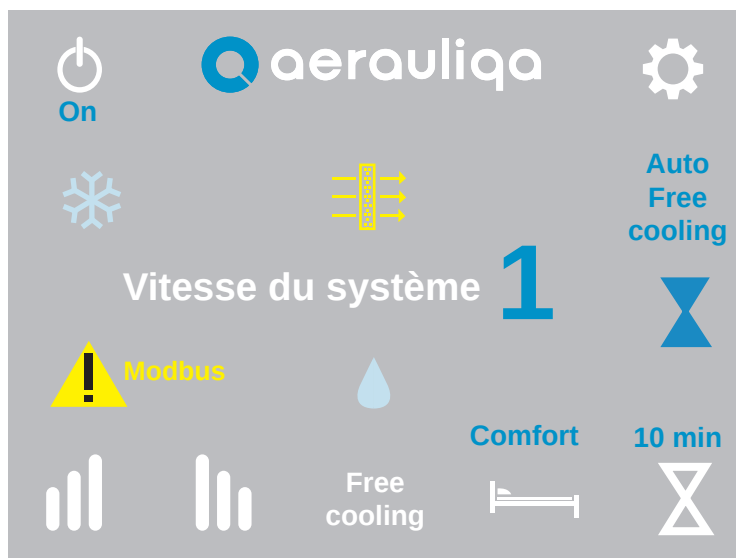

DIP SWITCH				
ADRESSE	1	2	3	
1	0	0	0	default
2	0	0	on	
3	0	on	0	
4	0	on	on	
5	on	0	0	
6	on	0	on	
7	on	on	0	
8	on	on	on	









4 FONCTIONNALITÉ

4.1 PAGE D'ACCUEIL

Attention : Le CTRL-HO est le panneau de contrôle à distance (master) qui permet de commander simultanément tous les appareils ORION connectés (slave). Il ne contrôle pas les appareils individuellement.



Touche	Description																		
	Sélection du mode "On" (les unités de ventilation fonctionnent) ou "Off" (les unités de ventilation ne fonctionnent pas)																		
	Accès à l'écran de configuration (section 4.4)																		
	Réglage de la vitesse : En touchant les symboles  ou  , vous augmentez ou diminuez la vitesse de toutes les unités connectées. L'écran affiche le numéro de la vitesse sélectionnée selon le tableau suivant : <table border="1" data-bbox="225 1227 667 1496"><thead><tr><th>VITESSE</th><th>ORION 100</th><th>ORION 150</th></tr></thead><tbody><tr><td>1</td><td>10 m³/h</td><td>20 m³/h</td></tr><tr><td>2</td><td>14 m³/h</td><td>30 m³/h</td></tr><tr><td>3</td><td>17 m³/h</td><td>40 m³/h</td></tr><tr><td>4</td><td>21 m³/h</td><td>50 m³/h</td></tr><tr><td>5</td><td>25 m³/h</td><td>60 m³/h</td></tr></tbody></table>	VITESSE	ORION 100	ORION 150	1	10 m ³ /h	20 m ³ /h	2	14 m ³ /h	30 m ³ /h	3	17 m ³ /h	40 m ³ /h	4	21 m ³ /h	50 m ³ /h	5	25 m ³ /h	60 m ³ /h
VITESSE	ORION 100	ORION 150																	
1	10 m ³ /h	20 m ³ /h																	
2	14 m ³ /h	30 m ³ /h																	
3	17 m ³ /h	40 m ³ /h																	
4	21 m ³ /h	50 m ³ /h																	
5	25 m ³ /h	60 m ³ /h																	
Free cooling	Appuyer sur cette touche pour activer manuellement la fonction Free Cooling (section 4.3) : lorsqu'elle est activée, l'icône Free Cooling apparaît sur l'écran.																		
	Mode Comfort/Efficiency : appuyez sur cette touche pour sélectionner le mode Comfort ou Efficiency (section 4.3). Comfort ou Efficiency s'affiche à l'écran																		
	Boost : appuyer sur cette touche pour activer le mode Boost. L'icône  apparaît sur l'écran. Le bouton vous permet également de sélectionner la durée de la fonction Boost (10-20-30 minutes) ou de la désactiver (section 4.3)																		

Touche	Description
	Alarme filtre : le symbole  apparaît lorsque l'entretien du filtre est nécessaire (section 4.3)
	Contrôle intelligent de l'humidité : le symbole  apparaît si le capteur d'humidité est actif (section 4.3)
	Antigel : le symbole  apparaît si la fonction antifreeze est activée (section 4.3)
 Modbus	Alarme Modbus : le symbole  apparaît si un ou plusieurs appareils ne parviennent pas à communiquer sur le réseau Modbus. Accéder à l'écran "Statut unité" (section 4.4.2)

4.2 RÉGLAGE DE LA LANGUE ET DU NOMBRE D'UNITÉS DE VENTILATION

Lors de la première mise sous tension, le CTRL-HO affiche l'écran suivant :



Touche	Description
Langues Set	Sélection de la langue (Italien, Anglais, Français, Espagnol ou Allemand)
Unités Set	Réglage du nombre d'unités du système (jusqu'à un maximum de 8)
Ok	Accès à l'écran suivant

En appuyant sur le bouton OK, vous accédez à l'écran suivant :

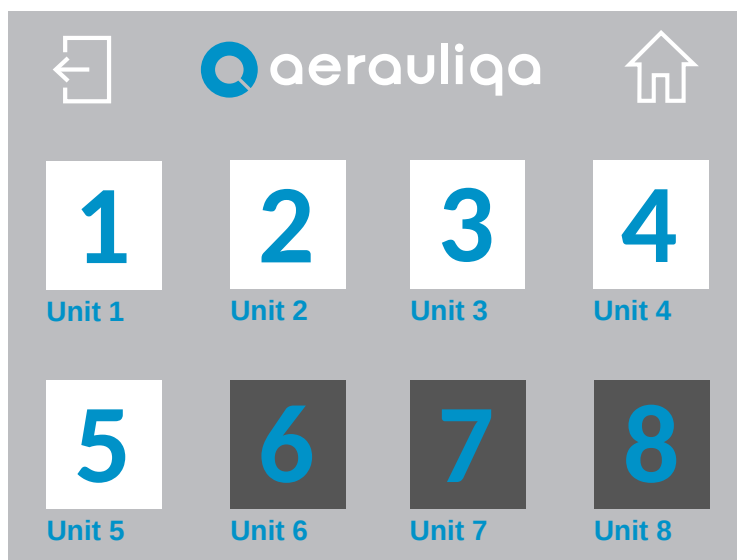

Touche	Description
	Retourner à l'écran précédent
	Retourner à l'écran d'accueil
	Sélection de l'appareil connecté

En appuyant sur la touche numérique, vous accédez à l'écran suivant :

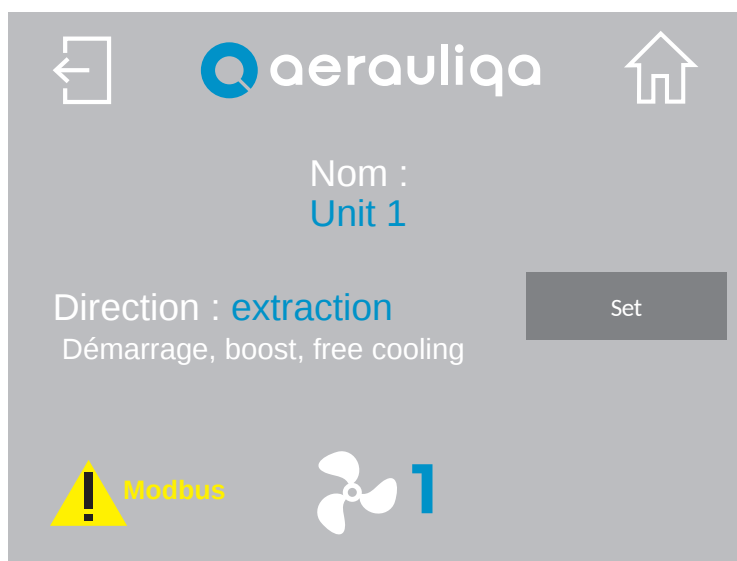

Touche	Description
	Retourner à l'écran précédent
	Retourner à l'écran d'accueil
Unit 1	En touchant le texte, il est possible de modifier le nom de l'unité
Set	Sélection de la direction du flux d'air (extraction ou insufflation) lors de la première mise en marche de l'appareil ou lorsque l'appareil est en mode Boost et en mode Free Cooling
	Toucher le symbole permet de passer à l'écran de l'unité suivante
Modbus	Alarme Modbus : le symbole apparaît si un ou plusieurs appareils ne parviennent pas à communiquer sur le réseau Modbus. Accéder à l'écran "Statut unité" (section 4.4.2)



4.3 DESCRIPTION DES CARACTÉRISTIQUES

Fonctionnalité	Description	Commande	Icône/texte sur l'écran
Comfort	Les unités maximisent le confort thermique et acoustique. Le temps d'inversion varie automatiquement entre 40 et 120 secondes, grâce à la sonde de température intégrée. Le premier cycle de temps est de 70 secondes, puis il varie automatiquement en fonction des conditions détectées. La première unité qui inverse le flux entraîne l'inversion de tout le système.		Comfort
Efficiency	Les unités maximisent l'efficacité thermique. Le délai d'inversion est fixé à 70 secondes.		Efficiency
Free Cooling	Les unités fonctionnent en mode extraction ou en mode insufflation pendant une période de 30 minutes afin d'éviter la récupération de chaleur lorsqu'elle n'est pas nécessaire. Pour sélectionner la direction du flux d'air de chaque unité, voir la section 4.2.	Free cooling	-
	Free cooling manuel : peut être activé via le bouton sur l'écran.	-	Free Cooling
	Free cooling automatique : voir section 4.4.5 pour le réglage	Auto free cooling	Auto free cooling
Boost	Les unités fonctionnent à la vitesse 5 (maximum) pendant une période de temps sélectionnable via le bouton correspondant (10-20-30 minutes), puis reviennent au mode/à la vitesse précédemment réglé(e). Pour sélectionner la direction du flux d'air de chaque unité, voir la section 4.2.		
Réinitialiser filtre	Tous les 3 mois environ, cette icône apparaît sur l'écran, conseillant à l'utilisateur d'effectuer l'entretien du filtre sur tous les appareils. Pour réinitialiser la synchronisation, voir la section 4.4.1.	-	
Contrôle intelligent de l'humidité	Lorsque la sonde d'humidité d'un appareil détecte un changement soudain de l'humidité relative, la vitesse est automatiquement augmentée au niveau supérieur sur tous les appareils connectés. 10 minutes après le dernier changement brusque détecté par le même appareil, tous les appareils se remettent à fonctionner à la vitesse sélectionnée via le panneau de contrôle. Le contrôle de l'humidité n'est actif que si la direction du flux d'air des unités est alternée ou en extraction : si la vitesse 5 a été sélectionnée, l'intervention de la sonde d'humidité ne génère pas de variations. Pour désactiver cette fonction sur toutes les unités, voir la section 4.4.5.	-	
Night Mode	Si elle est active, de 20 heures à 8 heures (non modifiable), la fonction de contrôle de l'humidité est désactivée sur toutes les unités connectées. Pour activer/désactiver cette fonction, voir la section 4.4.5.	-	-
Antigel	Cette fonction concerne l'appareil individuel et empêche que de l'air trop froid passe à travers l'échangeur céramique, pour éviter de l'endommager. Lorsqu'elle est activée, l'appareil fonctionne en mode extraction seule à la vitesse 1 pendant 30 minutes.	-	

4.4 CONFIGURATION

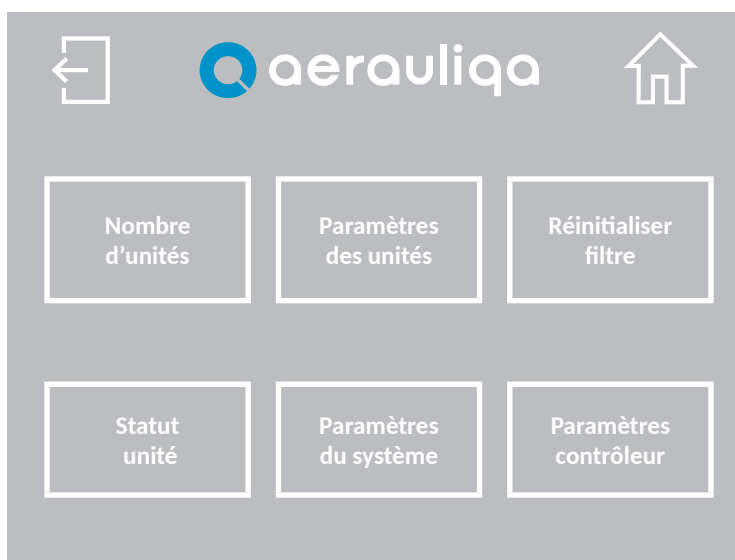

En appuyant sur la touche  vous accédez à l'écran suivant :



Touche	Description
	Retourner à l'écran précédent
	Retourner à l'écran d'accueil
Nombre d'unités	Réglage du nombre d'unités connectées (section 4.2)
Paramètres des unités	Réglage de la direction du flux d'air de chaque unité (section 4.2)
Réinitialiser filtre	Élimination de l'alarme du filtre et réinitialisation de la temporisation (section 4.4.1)
Statut unité	Informations sur le statut de chaque unité (section 4.4.2)
Paramètres du système	Réglage de la langue, du volume, du rétroéclairage et du mot de passe (section 4.4.3)
Réglages contrôle	Réglage du free cooling, du Night mode et du contrôle de l'humidité (section 4.4.5)



4.4.1 RÉINITIALISER FILTRE



Touche	Description
	Retourner à l'écran précédent
	Retourner à l'écran d'accueil
Ok	Effacer l'alarme de filtre, réinitialiser le timer et revenir à l'écran précédent

4.4.2 STATUT DE L'UNITÉ



Touche	Description
	Retourner à l'écran précédent
	Retourner à l'écran d'accueil
	Sélection du numéro de l'unité à laquelle l'écran se réfère

Si nécessaire, suivez les instructions affichées à l'écran pour résoudre le problème ou contactez l'assistance technique.

4.4.3 PARAMÈTRES DU SYSTÈME

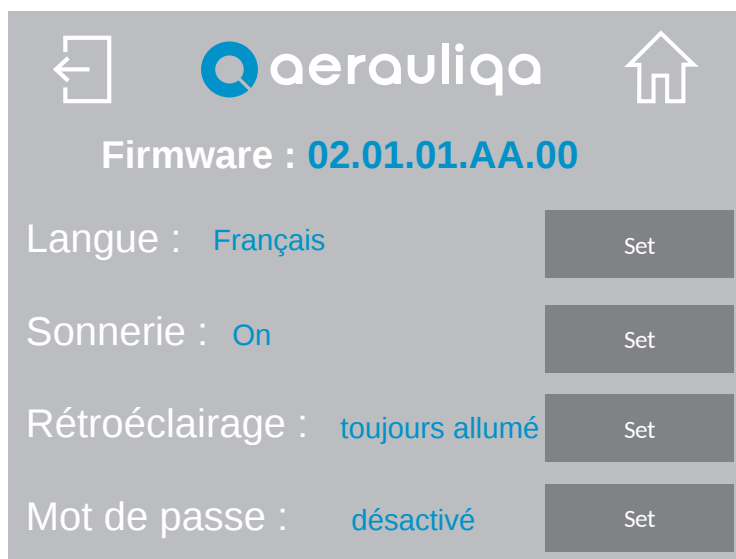

Touche	Description
←	Retourner à l'écran précédent
🏠	Retourner à l'écran d'accueil
Firmware	Référence du Firmware chargé sur le panneau de contrôle
Langues Set	Sélection de la langue (Italien, Anglais, Français, Espagnol ou Allemand)
Sonnerie Set	Réglage du signal acoustique : choix entre "On" et "Off"
Rétroéclairage Set	Réglage de l'allumage de l'écran : choix entre "toujours allumé" et "temporisé"
Mot de passe	Définition du mot de passe (section 4.4.4)

4.4.4 MOT DE PASSE

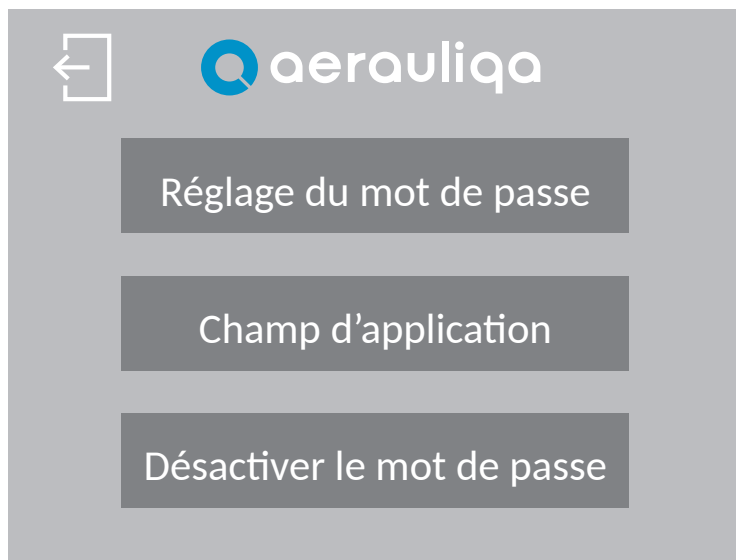

Touche	Description
	Retourner à l'écran précédent
Réglage	Réglage du mot de passe (saisie de chiffres uniquement de 1 à 9999)
Champ	Choisir si protéger "toutes les pages" ou seulement "les pages de configuration"
Désactiver	Désactiver le mot de passe

En appuyant sur le bouton "Réglage du mot de passe", l'écran suivant s'affiche :

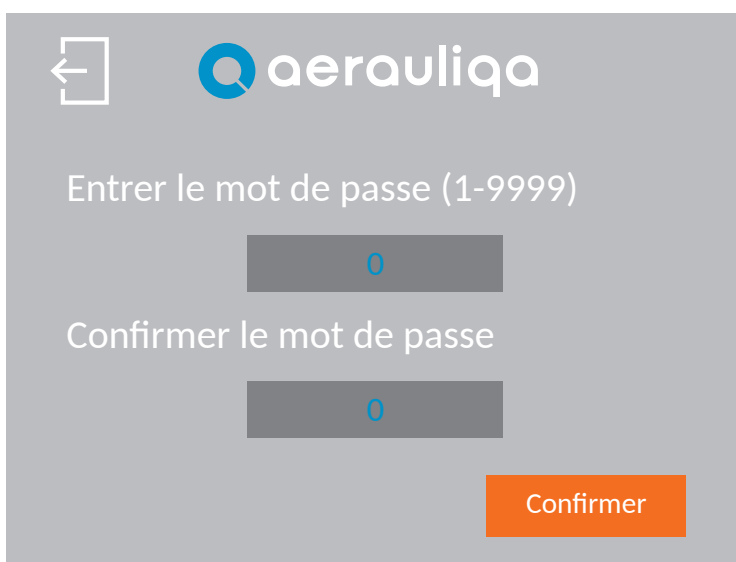

Touche	Description
	Retourner à l'écran précédent
0	Saisir deux fois le mot de passe
Confirmer	Appuyer pour confirmer/activer le mot de passe

L'écran suivant s'affiche lorsque l'on appuie sur le bouton "Champ d'application" du mot de passe :



Touche	Description
	Retour à l'écran précédent
Set	Sélection des pages à protéger : "Toutes les pages" ou "Pages de configuration"
Confirmer	Appuyer pour confirmer

Si le mot de passe est activé, l'écran suivant s'affiche lorsque cela est nécessaire.

Saisissez le mot de passe correct pour continuer.

Si l'écran ne change pas, vérifiez le mot de passe et réessayez.

Si le mot de passe a été oublié, contactez le service clients.

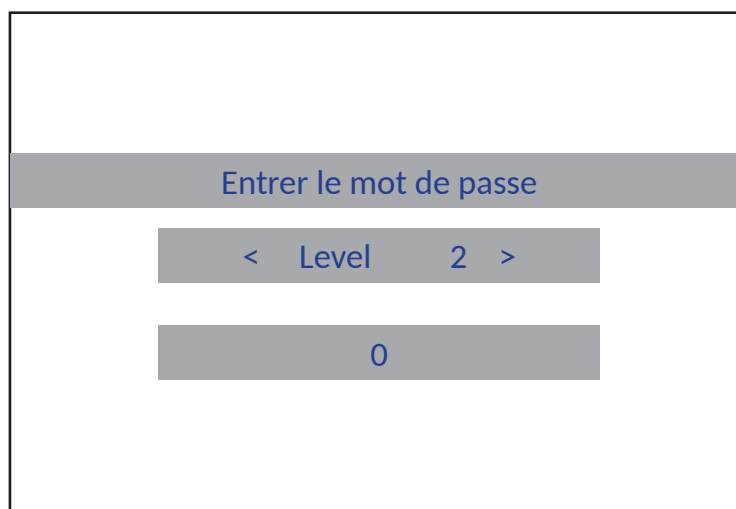



En appuyant sur le bouton "Désactiver le mot de passe", l'écran suivant s'affiche :

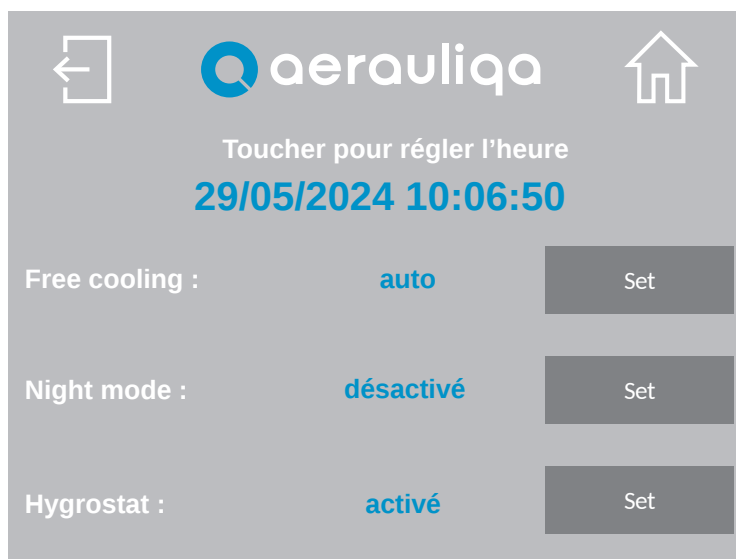

Touche	Description
	Retour à l'écran précédent
0	Entrer le mot de passe
Confirmer	Appuyer pour désactiver le mot de passe

4.4.5 PARAMÈTRES DU CONTRÔLEUR



Touche	Description
	Retourner à l'écran précédent
	Retourner à l'écran d'accueil
Free cooling Set	Sélection "manuel" ou "automatique" du Free Cooling (section 4.3)
Night mode Set	Activation/désactivation du Night mode (section 4.3)
Hygrostat Set	Activation/désactivation du contrôle intelligent de l'humidité (section 4.3)

CTRL-H0

Bedienfeld für ORION SYSTEM

INDEX

1 VORSICHTSMAßNAHMEN.....	41
2 INSTALLATION.....	41
3 SCHALTPLAN.....	41
3.1 MODBUS-ANSCHLUß.....	41
4 BETRIEB.....	43
4.1 HOME PAGE.....	43
4.2 EINSTELLUNG DER SPRACHE UND DER ANZAHL DER LÜFTUNGSEINHEITEN.....	44
4.3 FUNKTIONALITÄTSBESCHREIBUNG.....	46
4.4 KONFIGURATION.....	47
4.4.1 FILTER RESET.....	48
4.4.2 STATUS DER LÜFTUNGSEINHEIT.....	48
4.4.3 SYSTEMEINSTELLUNG.....	49
4.4.4 PASSWORT.....	50
4.4.5 BEDIENFELDEINSTELLUNG.....	53

Lesen Sie dieses Handbuch vor der Verwendung des Produkts sorgfältig durch und bewahren Sie es zum Nachschlagen auf. Dieses Produkt wurde normgerecht und in Übereinstimmung mit den Vorschriften für elektrische Geräte gebaut und muss von technisch qualifiziertem Personal installiert werden. Der Hersteller übernimmt keine Verantwortung für Personen- oder Sachschäden, die sich aus der Nichtbeachtung der in dieser Broschüre enthaltenen Vorschriften ergeben.

1 VORSICHTSMAßNAHMEN

- Vergewissern Sie sich, daß die Stromzufuhr zum Gerät unterbrochen ist, bevor Sie Installations-, Service-, Wartungs- oder Elektroarbeiten durchführen!
- Die Installation und Wartung des Geräts und der gesamten Lüftungsanlage muß von einem autorisierten Installateur und in Übereinstimmung mit den örtlichen Vorschriften und Bestimmungen durchgeführt werden.
- Wenn Sie eine Betriebsstörung feststellen, trennen Sie das Gerät vom Stromnetz und wenden Sie sich sofort an einen qualifizierten Techniker.
- Dieses Gerät kann von Kindern ab 8 Jahren und darüber sowie von Personen mit verringerten physischen, sensorischen oder geistigen Fähigkeiten oder Mangel an Erfahrung und Wissen benutzt werden, wenn sie beaufsichtigt oder bezüglich des sicheren Gebrauchs des Geräts unterwiesen wurden und die daraus resultierenden Gefahren verstehen. Kinder dürfen nicht mit dem Gerät spielen. Reinigungs- und Wartungsarbeiten dürfen von Kindern nicht ohne Aufsicht durchgeführt werden.
- Eine falsche elektrische Verdrahtung kann zu Schäden am Ventilator führen und andere elektronische Geräte stören.

2 INSTALLATION

Siehen Sie die in der Verpackung des Bedienfelds enthaltene Anleitung oder die Website www.aerauliqa.com



3 SCHALTPLAN

Siehen Sie die in der Verpackung des Bedienfelds enthaltene Anleitung oder die Website www.aerauliqa.com



ACHTUNG: Das Bedienfeld muß mit 24 VAC 50/60Hz mit einer maximalen Belastung von 4VA oder 12÷30VDC mit einer maximalen Belastung von 2W Versorgt werden.

3.1 MODBUS-ANSCHLUß

- Verwenden Sie einen Twisted-Pair-Kabel
- Kabelquerschnitt mindestens 24AWG (0,5mm)
- Maximale Länge des Twisted-Pair-Kabels zwischen den einzelnen Geräte des Systems: 30m

Wenn mehrere Lüftungsgäräte (**bis zu 8**) an das Bedienfeld angeschlossen werden sollen, muß die Verbindung einen Anfang (Bedienfeld) und ein Ende (letztes Gerät) haben, wie in der Abbildung unten gezeigt.

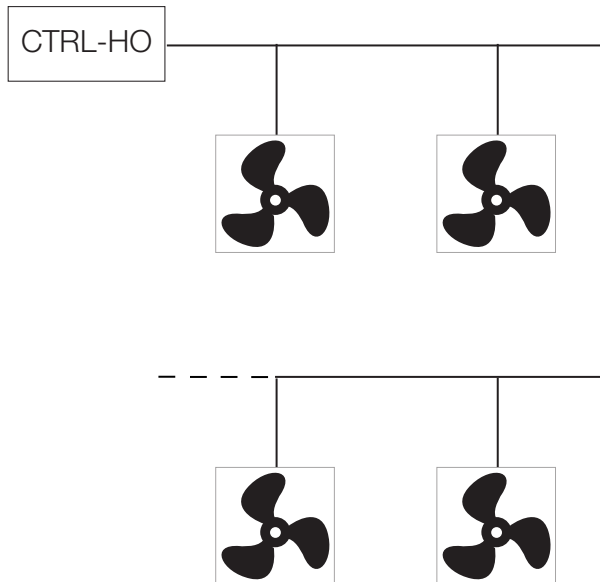

Wenn die Geräte nicht gemäß dem obigen Diagramm angeschlossen werden, könnte es zu einer Verschlechterung des Kommunikationssignals kommen und das Netzwerk könnte nicht richtig funktionieren.

⚠ Um die folgende Vorgänge durchzuführen, müssen das Bedienfeld und das Gerät müssen von der Hauptstromversorgung getrennt werden.

Es wird empfohlen, den Abschlußwiderstand am Bedienfeld und am letzten an die Modbus-Leitung angeschlossenem Gerät wie folgt zu aktivieren.

- Bedienfeld: Siehen Sie die in der Verpackung enthaltene Installationsanleitung oder wenden Sie sich an www.aerauliqa.com.



- Letzte Lüftungsgerät: der Abschlußwiderstand kann über den Dip-Schalter 4 aktiviert werden, der sich auf der elektronischen Platine des Sockels befindet, und zwar wie folgt:

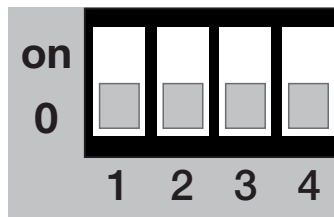
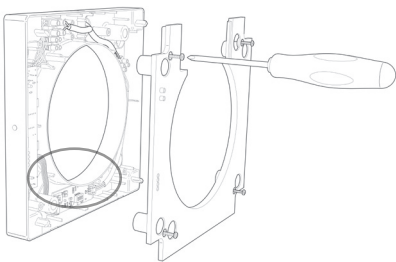

DIP SWITCH		
4	ABSCHLUßWIDERSTAND	
0	Abschlußwiderstand DEAKTIVIERT	standard
on	Abschlußwiderstand AKTIVIERT	

Mit den Dip-Schaltern 1-2-3 kann die Modbus-Adresse jedes Geräts beginnend mit der Nummer 1 eingestellt werden.









DIP SWITCH				
ADRESSE	1	2	3	
1	0	0	0	standard
2	0	0	on	
3	0	on	0	
4	0	on	on	
5	on	0	0	
6	on	0	on	
7	on	on	0	
8	on	on	on	









4 BETRIEB

4.1 HOME PAGE

Achtung: Das CTRL-HO ist das Fernbedienungspanel (Master), mit dem alle angeschlossenen ORION-Geräte (Slaves) gleichzeitig gesteuert werden können. Es steuert die Geräte nicht einzeln.



Taste	Beschreibung																		
	Moduswahl "On" (Lüftungsgeräte laufen) oder "Off" (Lüftungsgeräte laufen nicht).																		
	Zugang zu den Einstellungen (Abschnitt 4.4)																		
	<p>Geschwindigkeitseinstellung: Durch Berühren der Symbole  oder  wird die Geschwindigkeit aller angeschlossenen Geräte erhöht oder verringert. Auf dem Display wird die Nummer der gewählten Geschwindigkeit gemäß der folgenden Tabelle angezeigt:</p> <table border="1"> <thead> <tr> <th>GESCHWINDIGKEIT</th> <th>ORION 100</th> <th>ORION 150</th> </tr> </thead> <tbody> <tr> <td>1</td> <td>10 m³/h</td> <td>20 m³/h</td> </tr> <tr> <td>2</td> <td>14 m³/h</td> <td>30 m³/h</td> </tr> <tr> <td>3</td> <td>17 m³/h</td> <td>40 m³/h</td> </tr> <tr> <td>4</td> <td>21 m³/h</td> <td>50 m³/h</td> </tr> <tr> <td>5</td> <td>25 m³/h</td> <td>60 m³/h</td> </tr> </tbody> </table>	GESCHWINDIGKEIT	ORION 100	ORION 150	1	10 m ³ /h	20 m ³ /h	2	14 m ³ /h	30 m ³ /h	3	17 m ³ /h	40 m ³ /h	4	21 m ³ /h	50 m ³ /h	5	25 m ³ /h	60 m ³ /h
GESCHWINDIGKEIT	ORION 100	ORION 150																	
1	10 m ³ /h	20 m ³ /h																	
2	14 m ³ /h	30 m ³ /h																	
3	17 m ³ /h	40 m ³ /h																	
4	21 m ³ /h	50 m ³ /h																	
5	25 m ³ /h	60 m ³ /h																	
Free cooling	Durch Berühren des Textes auf dem Display wird die Free Cooling (Freie Kühlung) manuell aktiviert (Abschnitt 4.3): wenn sie aktiviert ist, erscheint auf dem Display "Free Cooling".																		
	Comfort/Efficiency Modus: Berühren Sie die Taste, um den Comfort oder Efficiency Modus auszuwählen (Abschnitt 4.3). Auf dem Display erscheint "Comfort" oder "Efficiency"																		
	Boost: Durch Berühren der Taste wird der Boost-Modus aktiviert. Das Symbol  erscheint auf dem Display. Mit der Taste können Sie auch die Dauer der Boost-Funktion auswählen (10-20-30 Minuten) oder sie deaktivieren (Abschnitt 4.3)																		

Symbol	Beschreibung
	Filteralarm: das Symbol  erscheint, wenn eine Filterwartung erforderlich ist (Abschnitt 4.3)
	Intelligente Feuchtigkeitskontrolle: das Symbol  erscheint, wenn der Feuchtigkeitssensor aktiv ist (Abschnitt 4.3)
	Antifrost: das Symbol  erscheint, wenn die Frostschutzfunktion aktiv ist (Abschnitt 4.3)
 Modbus	Modbus Alarm: the symbol  erscheint, wenn ein oder mehrere Geräte nicht über das Modbus-Netzwerk kommunizieren können. Rufen Sie den Bildschirm "Gerätstatus" auf (Abschnitt 4.4.2)

4.2 EINSTELLUNG DER SPRACHE UND DER ANZAHL DER LÜFTUNGSEINHEITEN

Wenn das Bedienfeld zum ersten Mal eingeschaltet wird, wird der folgende Bildschirm angezeigt:

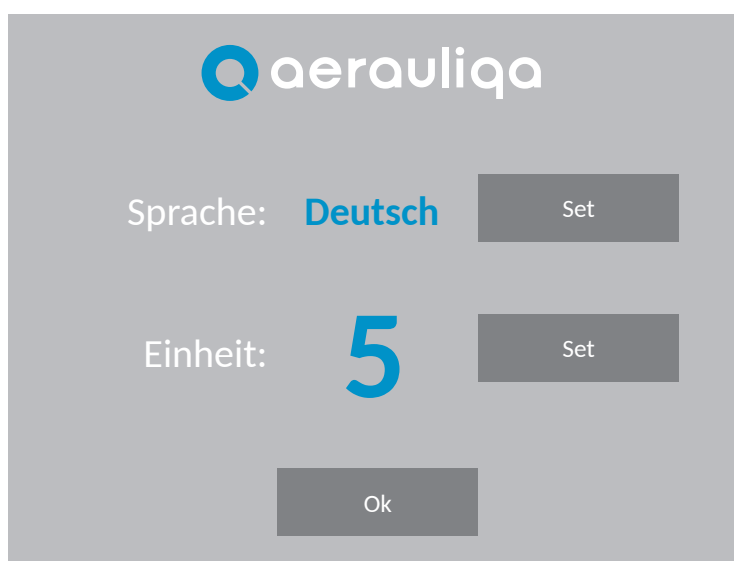

Taste	Beschreibung
Sprache Set	Sprachauswahl (Italienisch, Englisch, Französisch, Spanisch oder Deutsch)
Einheit Set	Einstellung der Anzahl der Einheiten des Systems (max 8 Stück)
Ok	Zustimmung zum Aufrufen des nächsten Bildschirms

Wenn Sie auf die Taste OK tippen, wird der folgende Bildschirm angezeigt:







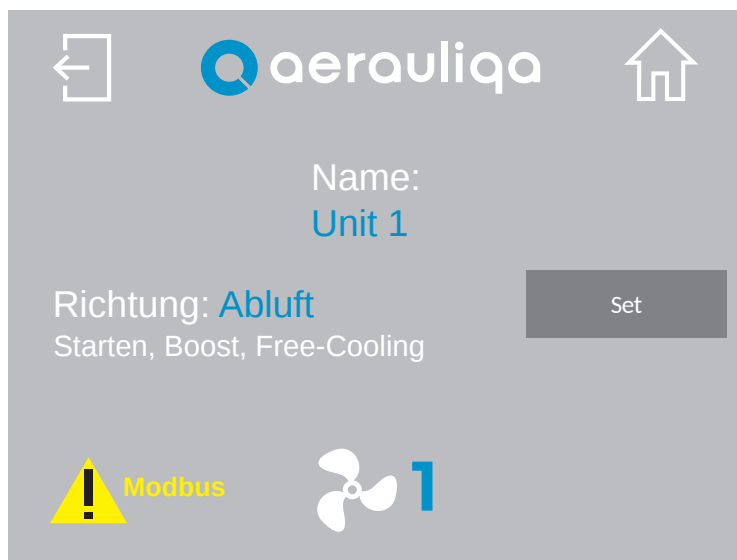

Taste	Beschreibung
	Zurück zum vorherigen Bildschirm
	Zurück zur Home Page
	Auswahl der angeschlossenen Einheit

Wenn Sie die Zifferntaste berühren, wird der folgende Bildschirm angezeigt:



Taste	Beschreibung
	Zurück zum vorherigen Bildschirm
	Zurück zur Home Page
Unit 1	Durch Berühren des Textes kann der Einheit ein Name zugewiesen werden
Set	Auswahl der Luftstromrichtung (Abluft oder Ansaugung) beim ersten Einschalten des Geräts oder wenn sich das Gerät im Boost-Modus und im Free Cooling-Modus befindet
	Berühren des Symbols wechselt zum nächsten Einheitenbildschirm
	Modbus-Alarm: Das Symbol erscheint, wenn eine oder mehrere Einheiten nicht über das Modbus-Netzwerk kommunizieren können. Zugriff auf den Bildschirm "Einheitstatus" (Abschnitt 4.4.2)



4.3 FUNKTIONALITÄTSBESCHREIBUNG

Funktionalität	Beschreibung	Taste	Symbol/Text auf dem Display
Comfort	Die Geräte sorgen für maximalen thermischen und akustischen Komfort. Die Inversionszeit variiert automatisch zwischen 40÷120 Sekunden, dank des integrierten Temperatursensors. Der erste Zeitzyklus beträgt 70 Sekunden, danach variiert er automatisch in Abhängigkeit von den festgestellten Bedingungen. Die erste Einheit, die den Durchfluss umkehrt, bewirkt die Umkehrung des gesamten Systems.		Comfort
Efficiency	Die Geräte maximieren die thermische Effizienz. Die Inversionszeit ist auf 70 Sekunden festgelegt.		Efficiency
Free Cooling	Die Geräte arbeiten 30 Minuten lang im reinen Abluft- oder reinen Ansaugbetrieb, um eine Wärmerückgewinnung zu vermeiden, wenn sie nicht benötigt wird. Zur Auswahl der Luftstromrichtung der einzelnen Geräte Siehen Sie Abschnitt 4.2	-	-
	Manuelles Free Cooling: kann über eine spezielle Taste auf dem Display aktiviert werden.	Free cooling	Free Cooling
	Automatisches, Free Cooling: Siehen Sie Abschnitt 4.4.5 zur Einstellung	Auto free cooling	Auto free cooling
Boost	Die Geräte arbeiten für einen über die entsprechende Taste wählbaren Zeitraum (10-20-30 Minuten) mit der Geschwindigkeit 5 (maximal) und kehren dann zur zuvor eingestellten Betriebsart/Geschwindigkeit zurück. Zur Auswahl der Luftstromrichtung der einzelnen Geräte Siehen Sie Abschnitt 4.2.		
Filter Reset	Ungefähr alle 3 Monate erscheint das entsprechende Symbol auf dem Display und weist den Benutzer darauf hin, die Filterwartung an allen Geräten durchzuführen. Zum Zurücksetzen des Zeitplans Siehen Sie Abschnitt 4.4.1	-	
Intelligente Feuchtigkeits-Kontrolle	Wenn der Feuchtigkeitssensor eines Geräts eine schnelle Veränderung der relativen Luftfeuchtigkeit feststellt, wird die Geschwindigkeit bei allen angeschlossenen Geräten automatisch auf die höhere Geschwindigkeit erhöht. 10 Minuten nach der letzten schnellen Änderung, die von demselben Gerät erkannt wurde, kehren alle Geräte zum Betrieb mit der über das Bedienfeld gewählten Geschwindigkeit zurück. Die intelligente Feuchtigkeitskontrolle ist nur aktiv, wenn die Luftstromrichtung der Geräte auf Umluft oder Abluft eingestellt ist: wenn die Geschwindigkeit 5 gewählt wurde, erzeugt der Eingriff der Feuchtesonde keine Schwankungen. Um diese Funktion bei allen Geräten zu deaktivieren, Siehen Sie Abschnitt 4.4.5	-	
Night Mode	Wenn diese Funktion aktiviert ist, wird sie von 20.00 Uhr bis 8.00 Uhr (kann nicht geändert werden) für alle angeschlossenen Geräte deaktiviert. Um diese Funktion zu aktivieren/deaktivieren, Siehen Sie Abschnitt 4.4.5	-	-
Antifrost	Diese Funktion bezieht sich auf das einzelne Gerät und verhindert, daß zu kalte Luft durch den Keramiktauscher strömt und diesen beschädigen könnte. Wenn diese Funktion aktiviert ist, arbeitet das Gerät im Absaugmodus 30 Minuten lang auf Stufe 1.	-	

4.4 KONFIGURATION

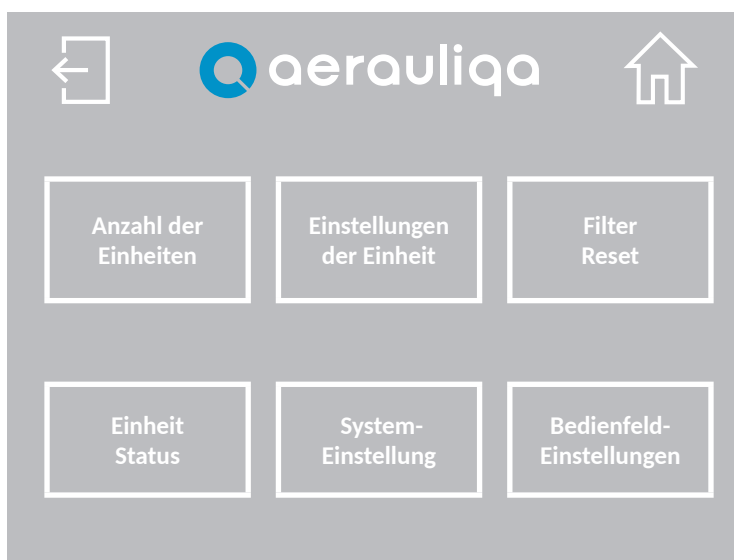

Wenn Sie die Taste  berühren, wird der folgende Bildschirm angezeigt:



Taste	Beschreibung
	Zurück zum vorherigen Bildschirm
	Zurück zur Home Page
Anzahl der Einheiten	Einstellung der Anzahl der angeschlossenen Geräte (Abschnitt 4.2)
Einstellung der Einheit	Einstellung der Luftstromrichtung der einzelnen Geräte (Abschnitt 4.2)
Filter Reset	Zurücksetzung des Filteralarms und des Timers (Abschnitt 4.4.1)
Einheit Status	Informationen über den Status der einzelnen Einheiten (Abschnitt 4.4.2)
System-Einstellungen	Einstellung der Sprache, des Summers, der Hintergrundbeleuchtung und des Passworts (Abschnitt 4.4.3)
Kontrolle Einstellungen	Einstellung des Free Cooling Modus, des Night Mode und der intelligenten Feuchtigkeitskontrolle (Abschnitt 4.4.5)



4.4.1 FILTER RESET



Taste	Beschreibung
	Zurück zum vorherigen Bildschirm
	Zurück zur Home Page
Ok	Alarm löschen, Timer zurücksetzen und zum vorherigen Bildschirm zurückkehren

4.4.2 STATUS DER LÜFTUNGSEINHEIT



Taste	Beschreibung
	Zurück zum vorherigen Bildschirm
	Zurück zur Home Page
	Auswahl der Nummer der Einheit, auf die sich der Bildschirm bezieht

Befolgen Sie ggf. die Anweisungen auf dem Display, um das Problem zu lösen, oder wenden Sie sich an den technischen Kundendienst.

4.4.3 SYSTEMEINSTELLUNGEN



Taste	Beschreibung
	Zurück zum vorherigen Bildschirm
	Zurück zur Home Page
Firmware	Firmware-Referenz auf das Bedienfeld geladen
Sprache Set	Sprachauswahl (Italienisch, Englisch, Französisch, Spanisch oder Deutsch)
Buzzer Set	Einstellung des Signaltons: Wählen Sie "On" oder "Off"
Beleuchtung Set	Einstellung der Hintergrundbeleuchtung: Wählen Sie "immer aktiviert" oder "zeitgesteuert"
Passwort	Einstellung des Passworts (Abschnitt 4.4)

4.4.4 PASSWORT



Taste	Beschreibung
	Zurück zum vorherigen Bildschirm
Festlegen	Passwortinstellung (nur Zahlen eingeben, 1 bis 9999)
Bereich	Wählen Sie, ob Sie "Alle Seiten" oder nur "Einstellungsseiten" schützen möchten
Deaktivieren	Passwort deaktivieren

Wenn Sie auf die Taste "Passwort festlegen" tippen, wird der folgende Bildschirm angezeigt:



Schaltfläche	Beschreibung
	Zurück zum vorherigen Bildschirm
0	Passwort zweimal eingeben
Bestätigen	Tippen Sie auf, um das Passwort zu bestätigen/aktivieren

Wenn Sie auf die Taste “Passwortbereich” tippen, wird der folgende Bildschirm angezeigt:



Schaltfläche	Beschreibung
	Zurück zum vorherigen Bildschirm
Set	Auswahl der zu schützenden Seiten zwischen “Alle Seiten” oder “Einstellungsseiten”.
Bestätigen	Bestätigung

Wenn das Passwort aktiviert ist, wird der folgende Bildschirm angezeigt.

Geben Sie das richtige Passwort ein, um fortzufahren.

Wenn sich der Bildschirm nicht ändert, überprüfen Sie das Passwort und versuchen Sie es erneut.

Wenn Sie das Passwort vergessen haben, wenden Sie sich an den Kundendienst.

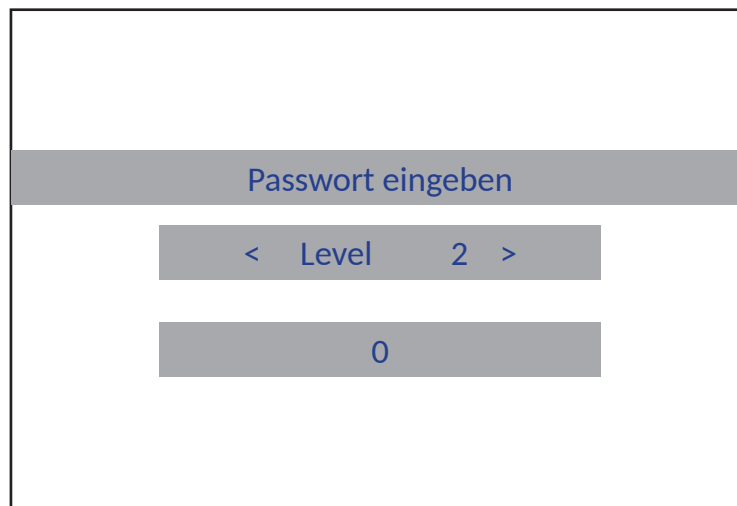



Wenn Sie die Taste "Passwort deaktivieren" berühren, wird der folgende Bildschirm angezeigt:

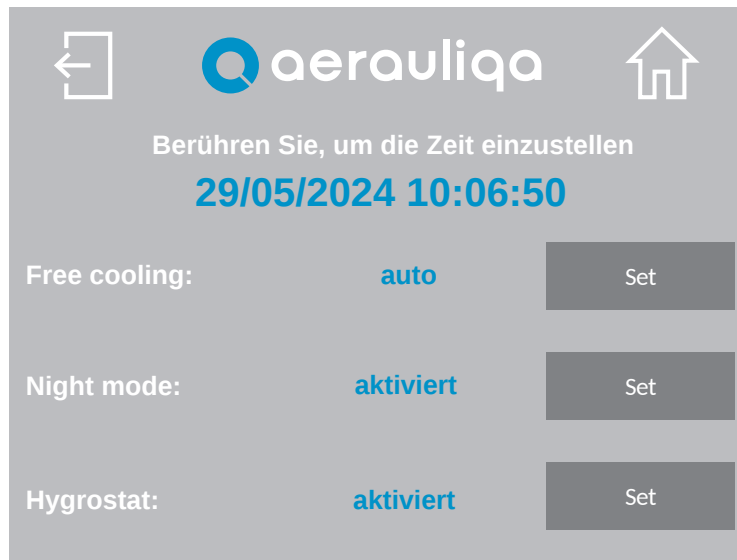

Schaltfläche	Beschreibung
	Zurück zum vorherigen Bildschirm
0	Passwort eingeben
Bestätigen	Tippen Sie auf, um das Passwort zu deaktivieren

4.4.5 BEDIENFELDEINSTELLUNGEN



Schaltfläche	Beschreibung
	Zurück zum vorherigen Bildschirm
	Zurück zur Home Page
Free cooling Set	Auswahl des "manuellen" oder "automatischen" Free Cooling (Abschnitt 4.2)
Night mode Set	Aktivieren/Deaktivieren des Nachtmodus (Abschnitt 4.2)
Hygrostat Set	Aktivieren/Deaktivieren der intelligenten Feuchtigkeitskontrolle (Abschnitt 4.2)

CTRL-H0

Panel de control táctil para el SISTEMA ORION

ÍNDICE

1 PRECAUCIONES.....	54
2 INSTALACIÓN.....	54
3 CONEXIÓN ELÉCTRICA.....	54
3.1 CONEXIÓN MODBUS.....	54
4 FUNCIONALIDAD.....	56
4.1 PÁGINA DE INICIO.....	56
4.2 CONFIGURACIÓN DEL IDIOMA DEL SISTEMA Y DEL NÚMERO DE UNIDAD.....	57
4.3 DESCRIPCIÓN DE FUNCIONES.....	59
4.4 CONFIGURACIÓN.....	60
4.4.1 RESET FILTRO.....	61
4.4.2 ESTADO UNIDAD.....	61
4.4.3 AJUSTES DEL SISTEMA.....	62
4.4.4 CONTRASEÑA.....	63
4.4.5 CONFIGURACIÓN CONTROLADOR.....	65

Lea atentamente este manual antes de utilizar el producto y guárdelo en un lugar seguro para poder consultarlo en caso necesario. El producto está construido de forma profesional y conforme a la normativa vigente en materia de material eléctrico y debe ser instalado por personal técnicamente cualificado. El fabricante no se hace responsable de los daños personales o materiales derivados del incumplimiento de las normas contenidas en este folleto.

1 PRECAUCIONES

- Asegúrese de que el interruptor principal del sistema esté desconectado antes de realizar cualquier instalación, mantenimiento ordinario o extraordinario o conexión eléctrica!
- La instalación, el mantenimiento y la localización de averías de la central deben ser realizados por un instalador autorizado y de conformidad con las leyes y reglamentos vigentes.
- Si se detecta una avería, desconecte el producto de la red eléctrica y póngase en contacto inmediatamente con un técnico cualificado.
- Este aparato puede ser utilizado por niños de al menos 8 años de edad y por personas con capacidades físicas, sensoriales o mentales reducidas o con experiencia y conocimientos insuficientes, siempre que se les supervise o instruya cuidadosamente sobre cómo utilizar el aparato de forma segura y sobre los peligros que conlleva. Asegúrese de que los niños no jueguen con el aparato. La limpieza y el mantenimiento por parte del usuario no deben ser realizados por niños sin supervisión.
- Una conexión eléctrica incorrecta puede dañar el ventilador e interferir con otros dispositivos electrónicos.

2 INSTALACIÓN

Consulte el manual de instalación suministrado en el paquete del panel de control o consulte el sitio web www.aerauliqa.com



3 CONEXIÓN ELÉCTRICA

Consulte el manual de instalación suministrado en el paquete del panel de control o consulte el sitio web www.aerauliqa.com



ATENCIÓN: el panel de control debe alimentarse a 24 VAC 50/60Hz con una carga máxima de 4VA o 12÷30VDC con una carga máxima de 2W.

3.1 CONEXIÓN MODBUS

- Utilice cable de par trenzado
- Sección del cable mín. 24AWG (0,5 mm)
- Longitud máxima del cable de par trenzado entre cada dispositivo del sistema: 30 m.

Si se va a conectar más de una unidad (**máx. 8**) al panel de control, la conexión a realizar debe tener un principio (panel de control) y un final (última unidad), como se muestra en la siguiente imagen.

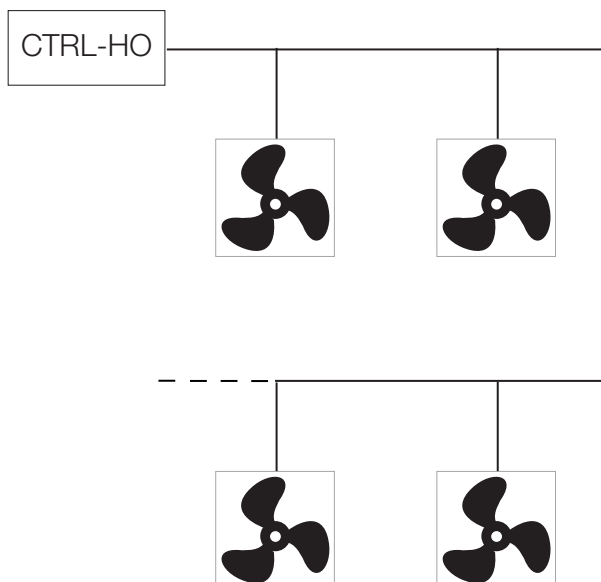

Si las unidades no se conectan según el diagrama anterior, puede producirse una degradación de la señal de comunicación y la red puede no funcionar correctamente.

⚠ Antes de realizar las siguientes operaciones el panel y la unidad deben desconectarse de la fuente de alimentación principal.

Se recomienda habilitar la resistencia de terminación en el panel de control y en la última unidad conectada a la línea Modbus de la siguiente manera:

- Panel de control: consulte el manual de instalación suministrado en el embalaje o consulte el sitio web www.aerauliqa.com



- Última unidad de ventilación: La resistencia de terminación se puede activar a través del Dip Switch 4 situado en el circuito electrónico de la base de apoyo de la siguiente manera:

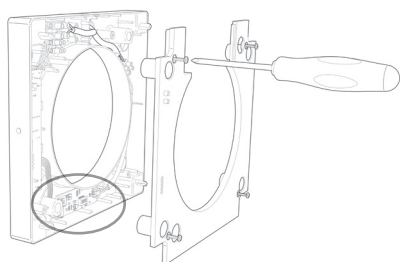

DIP SWITCH		
4	RESISTENCIA DE TERMINACIÓN	
0	Resistencia de terminación DESACTIVADO	default
on	Resistencia de terminación ACTIVADA	

Mediante los interruptores Dip Switch 1-2-3 es posible configurar la dirección Modbus de cada unidad empezando por el número 1.









DIP SWITCH				
DIRECCIÓN	1	2	3	
1	0	0	0	default
2	0	0	on	
3	0	on	0	
4	0	on	on	
5	on	0	0	
6	on	0	on	
7	on	on	0	
8	on	on	on	









4 FUNCIONALIDAD

4.1 PÁGINA DE INICIO

Atención: El CTRL-HO es el panel de control remoto (maestro) que permite controlar simultáneamente todas las unidades ORION conectadas (esclavas). No controla las unidades individualmente.



Botón	Descripción																		
	Selección de modo “On” (las unidades de ventilación están en funcionamiento) o “Off” (las unidades de ventilación no están en funcionamiento)																		
	Acceso a la pantalla de configuración (sección 4.4)																		
	<p>Ajuste de velocidad: Tocando los símbolos  o  se aumenta o disminuye la velocidad de todas las unidades conectadas. La pantalla muestra el número de velocidad seleccionada según la siguiente tabla:</p> <table border="1"> <thead> <tr> <th>VELOCIDAD</th> <th>ORION 100</th> <th>ORION 150</th> </tr> </thead> <tbody> <tr> <td>1</td> <td>10 m³/h</td> <td>20 m³/h</td> </tr> <tr> <td>2</td> <td>14 m³/h</td> <td>30 m³/h</td> </tr> <tr> <td>3</td> <td>17 m³/h</td> <td>40 m³/h</td> </tr> <tr> <td>4</td> <td>21 m³/h</td> <td>50 m³/h</td> </tr> <tr> <td>5</td> <td>25 m³/h</td> <td>60 m³/h</td> </tr> </tbody> </table>	VELOCIDAD	ORION 100	ORION 150	1	10 m³/h	20 m³/h	2	14 m³/h	30 m³/h	3	17 m³/h	40 m³/h	4	21 m³/h	50 m³/h	5	25 m³/h	60 m³/h
VELOCIDAD	ORION 100	ORION 150																	
1	10 m³/h	20 m³/h																	
2	14 m³/h	30 m³/h																	
3	17 m³/h	40 m³/h																	
4	21 m³/h	50 m³/h																	
5	25 m³/h	60 m³/h																	
Free cooling	Tocando el texto de la pantalla se activa manualmente la función de free cooling (sección 4.3): cuando está activa aparece en la pantalla la mención texto Free Cooling aparece en la pantalla																		
	Modo Comfort/Efficiency: pulse el botón para seleccionar el modo Comfort o Efficiency (sección 4.3). El texto Comfort u Efficiency aparece en la pantalla																		
	Boost: Tocando el botón se activa el modo Boost. El icono  aparece en la pantalla. El botón también permite seleccionar la temporización de la función Boost (10-20-30 minutos) o desactivarla (sección 4.3)																		

Icono	Descripción
	Alarma filtro: el símbolo  aparece cuando es necesario realizar el mantenimiento del filtro (sección 4.3)
	Control inteligente de humedad: el símbolo  aparece si el sensor de humedad está activo (sección 4.3)
	Anticongelante: el símbolo  aparece si la función anticongelante está activa (sección 4.3)
 Modbus	Alarma Modbus: el símbolo  aparece si una o varias unidades no se comunican en la red Modbus. Acceder a la pantalla "Estado Unidad" (sección 4.4.2)

4.2 CONFIGURACIÓN DEL IDIOMA Y NÚMERO DE UNIDADES DEL SISTEMA

Cuando se enciende por primera vez, CTRL-HO muestra la siguiente pantalla:



Botón	Descripción
Idioma Set	Selección de idioma (Italiano, Inglés, Francés, Español o Alemán)
Unidades Set	Ajuste del número de unidades del sistema (hasta un máximo de 8)
Ok	Consentimiento para acceder a la siguiente pantalla

Al pulsar el botón OK se accede a la siguiente pantalla:

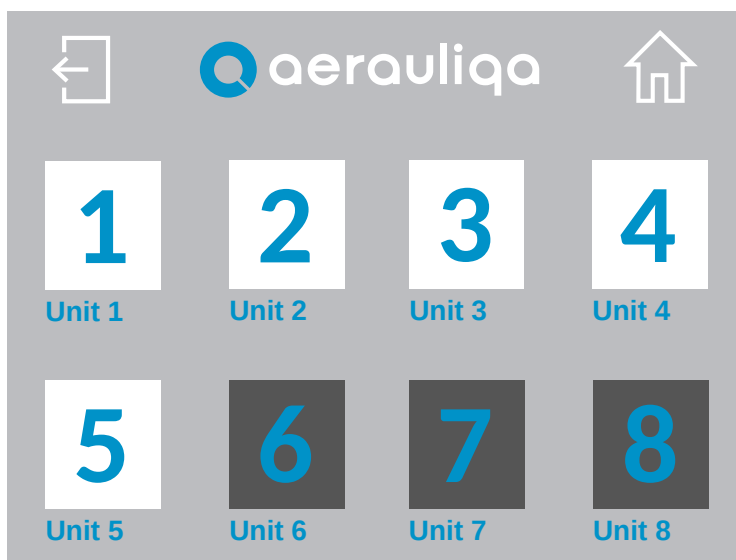





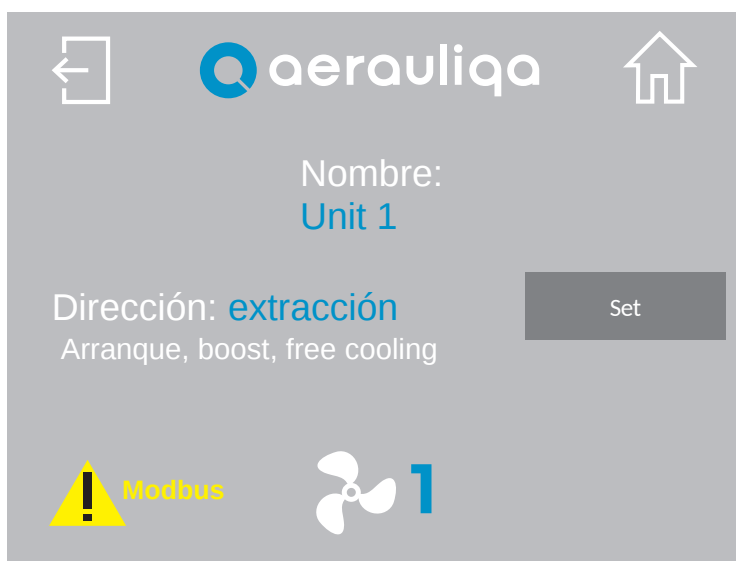

Botón	Descripción
	Volver a la pantalla anterior
	Volver a la pantalla de inicio
	Selección de la unidad conectada

Al pulsar la tecla numérica se accede a la siguiente pantalla:



Botón	Descripción
	Volver a la pantalla anterior
	Volver a la pantalla de inicio
Unit 1	Tocando el texto, se puede asignar un nombre a la unidad
Set	Selección de la dirección del flujo de aire (extracción o impulsión) cuando la unidad se enciende por primera vez o cuando la unidad está en modo Boost y en modo Free Cooling
	Tocando el símbolo se pasa a la pantalla de la unidad siguiente
Modbus	Alarma Modbus: el símbolo aparece si una o varias unidades no se comunican en la red Modbus. Acceder a la pantalla "Estado Unidad" (sección 4.4.2)



4.3 DESCRIPCIÓN DE FUNCIONES

Funciones	Descripción	Botón comando	Icono/texto en la pantalla
Comfort	Las unidades maximizan el confort térmico y acústico. El tiempo de inversión varía automáticamente entre 40÷120 segundos, gracias a la sonda de temperatura integrada. El primer ciclo de tiempo es de 70 segundos, después varía automáticamente en función de las condiciones detectadas. La primera unidad que invierte el flujo provoca la inversión de todo el sistema.		Comfort
Efficiency	Las unidades maximizan la eficiencia térmica. El tiempo de cambio de fuljo se fija a 70 segundos.		Efficiency
Free Cooling	Las unidades funcionan en modo sólo extracción o sólo impulsión durante un periodo de 30 minutos para evitar la recuperación de calor cuando no se necesita. Para seleccionar la dirección del flujo de aire de cada unidad, consulte la sección 4.2.	-	-
	Free Cooling manual: puede activarse mediante un botón especial situado en la pantalla.	Free cooling	Free Cooling
	Free Cooling automático: consulte la sección 4.4.5 para el ajuste.	Auto free cooling	Auto free cooling
Boost	Las unidades funcionan a velocidad 5 (máxima) durante un periodo de tiempo seleccionable mediante el botón correspondiente (10-20-30 minutos) y, a continuación, vuelven al modo/velocidad ajustado previamente. Para seleccionar la dirección del flujo de aire de cada unidad, consulte la sección 4.2.		
Reset filtro	Aproximadamente cada 3 meses, el icono correspondiente aparece en la pantalla, aconsejando al usuario que realice el mantenimiento del filtro en todas las unidades. Para restablecer la temporización, consulte la sección 4.4.1.	-	
Control inteligente de la humedad	Cuando la sonda de humedad de una unidad detecta un cambio brusco en la humedad relativa, la velocidad aumenta automáticamente al nivel superior en todas las unidades conectadas. 10 minutos después del último cambio brusco detectado por la misma unidad, todas las unidades vuelven a funcionar a la velocidad seleccionada a través del panel de control. El control de la humedad sólo está activo si la dirección del flujo de aire de las unidades es alterna o en extracción: si se ha seleccionado la velocidad 5, la intervención de la sonda de humedad no genera variaciones. Para desactivar esta función en todas las unidades, consulte la sección 4.4.5	-	
Night Mode	Si está activa, de 8 p.m. a 8 a.m. (no se puede cambiar) la función de control de humedad se desactiva en todas las unidades conectadas. Para activar/desactivar esta función, consulte la sección 4.4.5	-	-
Antifrost	Esta función se refiere a la unidad individual e impide el paso de aire excesivamente frío a través del intercambiador cerámico, con el riesgo de dañarlo. Cuando se activa, la unidad funciona en modo sólo extracción a velocidad 1 durante 30 minutos.	-	

4.4 CONFIGURACIÓN

Al pulsar el botón  se accede a la siguiente pantalla:



Botón	Descripción
	Volver a la pantalla anterior
	Volver a la pantalla de inicio
Numero de unidades	Ajuste del número de unidades conectadas (sección 4.2)
Config. unidad	Ajuste de la dirección del flujo de aire de cada unidad (sección 4.2)
Reset filtro	Restablecimiento de la alarma del filtro y restablecimiento de la temporización (sección 4.4.1)
Estado unidad	Información sobre el estado de cada unidad (sección 4.4.2)
Ajustes de sistema	Configuración del idioma, zumbador, retroiluminación y contraseña (sección 4.4.3)
Config. controlador	Ajustes de Free Cooling, Night Mode y control de humedad (sección 4.4.5)

4.4.1 RESET FILTRO



Botón	Descripción
	Volver a la pantalla anterior
	Volver a la pantalla de inicio
Ok	Restablecer la alarma y el temporizador y volver a la pantalla anterior

4.4.2 ESTADO UNIDAD



Botón	Descripción
	Volver a la pantalla anterior
	Volver a la pantalla de inicio
	Selección del número de unidad al que se refiere la pantalla

Si necesario, seguir las instrucciones de la pantalla para solucionar el problema o ponerse en contacto con el servicio de asistencia técnica.

4.4.3 AJUSTES DEL SISTEMA



Botón	Descripción
	Volver a la pantalla anterior
	Volver a la pantalla de inicio
Firmware	Referencia de firmware cargado en el panel de control
Idioma Set	Selección de idioma (Italiano, Inglés, Francés, Español o Alemán)
Zumbador Set	Configuración de la señal acústica: "On" o "Off"
Luz de fondo Set	Configuración luz de fondo: "activa" o "temporizada"
Contraseña	Configuración de contraseña (sección 4.4.4)

4.4.4 CONTRASEÑA

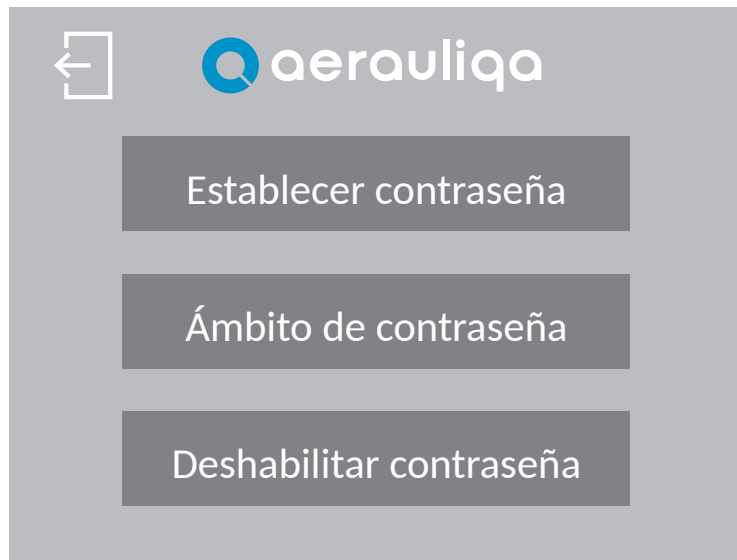

Botón	Descripción
	Volver a la pantalla anterior
Establecer	Establecimiento de contraseña (introduzca sólo números, del 1 al 9999)
Ámbito	Elegir si desea proteger "Todas las pantallas" o sólo "Pantallas de configuración".
Deshabilitar	Deshabilitar la contraseña

Al pulsar el botón "Establecer contraseña", aparece la siguiente pantalla:

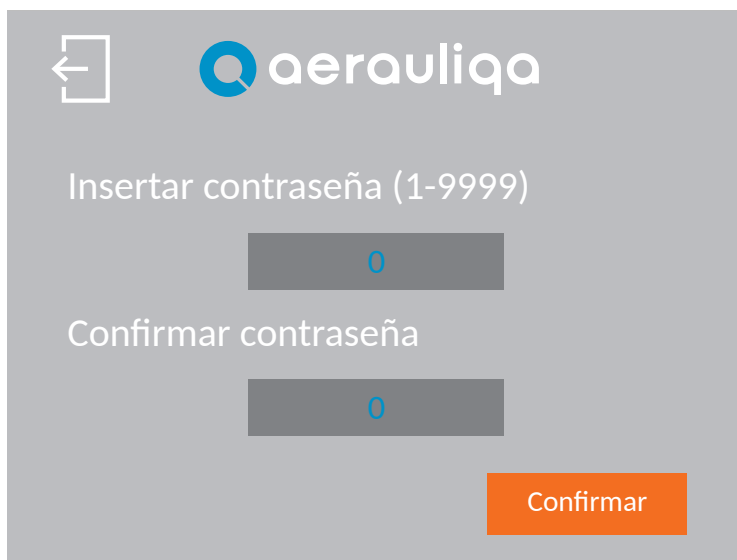

Botón	Descripción
	Volver a la pantalla anterior
0	Introduzca la contraseña dos veces
Confirmar	Pulsar para confirmar/activar la contraseña

Al pulsar el botón “Ámbito de contraseña” aparece la siguiente pantalla:



Botón	Descripción
	Volver a la pantalla anterior
Set	Selección de las páginas a proteger entre “Todas las pantallas” o “Pantalla de configuración”
Confirmar	Pulsar para confirmar

Si la contraseña está activada, la siguiente pantalla aparece cuando necesario:

Introducir la contraseña correcta para continuar.

Si la pantalla no cambia, comprobar la contraseña e inténtelo de nuevo.

Si ha olvidado la contraseña, ponerse en contacto con el servicio de atención al cliente.

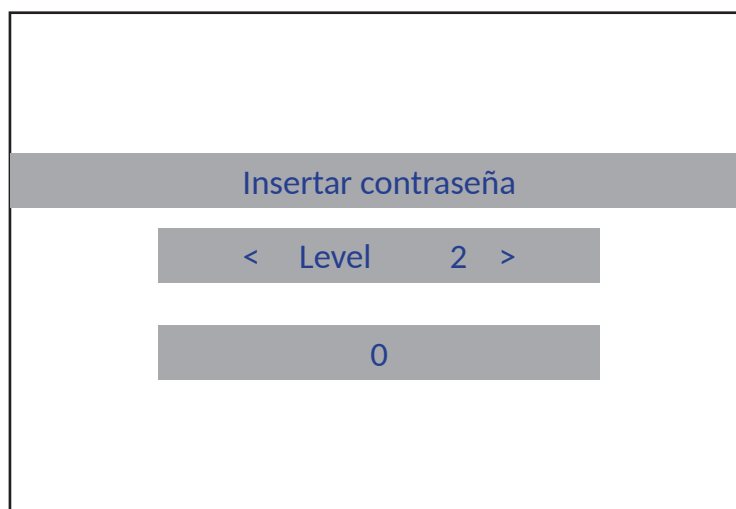

Al pulsar el botón “Desactivar Contraseña” aparece la siguiente pantalla:



Botón	Descripción
	Volver a la pantalla anterior
0	Introducir la contraseña
Confirmar	Pulsar para desactivar la contraseña

4.4.5 CONFIGURACIÓN CONTROLADOR



Botón	Descripción
	Volver a la pantalla anterior
	Volver a la pantalla de inicio
Free cooling Set	Selección “manuales” o “auto” de Free Cooling (sección 4.3)
Night mode Set	Activación/desactivación del modo nocturno (sección 4.3)
Humidistato Set	Activación/desactivación del control inteligente de la humedad (sección 4.3)



Aerauliqa srl - via Mario Calderara 39/41, 25018 Montichiari (Bs)

C.F. e P.IVA/VAT 03369930981 - REA BS-528635

Tel: +39 030 674681 - Fax: +39 030 6872149 - www.aerauliqa.com - info@aerauliqa.it

Aerauliqa srl si riserva il diritto di modificare/apportare migliorie ai prodotti e/o alle istruzioni di questo manuale in qualsiasi momento e senza preavviso.

Aerauliqa srl reserves the right to modify/make improvements to products and/or this instruction manual at any time and without prior notice.

Aerauliqa srl se réserve le droit de modifier / améliorer les produits et / ou les instructions contenus dans ce manuel à tout moment et sans préavis.

Aerauliqa srl behält sich das Recht vor, die Produkte und / oder Anweisungen in diesem Handbuch jederzeit und ohne vorherige Ankündigung zu ändern / zu verbessern.

Aerauliqa srl se reserva el derecho de modificar / mejorar los productos y / o las instrucciones en este manual en cualquier momento y sin previo aviso.